



**RIGOL**

# DG5000 Pro Series

Function/Arbitrary Waveform Generator

**User Guide**

Jul. 2025

## **Guaranty and Declaration**

### **Copyright**

© 2025 RIGOL TECHNOLOGIES CO., LTD. All Rights Reserved.

### **Trademark Information**

RIGOL® is the trademark of RIGOL TECHNOLOGIES CO., LTD.

### **Notices**

- RIGOL products are covered by P.R.C. and foreign patents, issued and pending.
- RIGOL reserves the right to modify or change parts of or all the specifications and pricing policies at the company's sole decision.
- Information in this publication replaces all previously released materials.
- Information in this publication is subject to change without notice.
- RIGOL shall not be liable for either incidental or consequential losses in connection with the furnishing, use, or performance of this manual, as well as any information contained.
- Any part of this document is forbidden to be copied, photocopied, or rearranged without prior written approval of RIGOL.

### **Product Certification**

RIGOL guarantees that this product conforms to the national and industrial standards in China as well as the ISO9001:2015 standard and the ISO14001:2015 standard. Other international standard conformance certifications are in progress.

### **Contact Us**

If you have any problem or requirement when using our products or this manual, please contact RIGOL.

E-mail: [service@rigol.com](mailto:service@rigol.com)

Website: <http://www.rigol.com>

| Section | Description                                                 | Page |
|---------|-------------------------------------------------------------|------|
|         | List of Figures.....                                        | V    |
|         | List of Tables.....                                         | VIII |
| 1       | Safety Requirement .....                                    | 1    |
| 1.1     | General Safety Summary .....                                | 1    |
| 1.2     | Safety Notices and Symbols .....                            | 3    |
| 1.3     | Measurement Category .....                                  | 3    |
| 1.4     | Ventilation Requirement .....                               | 4    |
| 1.5     | Working Environment .....                                   | 4    |
| 1.6     | Care and Cleaning .....                                     | 6    |
| 1.7     | Environmental Considerations .....                          | 6    |
| 2       | Product Features .....                                      | 8    |
| 3       | Document Overview .....                                     | 9    |
| 4       | Quick Start .....                                           | 11   |
| 4.1     | General Inspection .....                                    | 11   |
| 4.2     | Appearance .....                                            | 12   |
| 4.3     | Dimensions .....                                            | 13   |
| 4.4     | Product Overview .....                                      | 14   |
| 4.4.1   | Front Panel Overview .....                                  | 14   |
| 4.4.2   | Rear Panel Overview .....                                   | 20   |
| 4.4.3   | 2-Channel/4-Channel Model User Interface Overview .....     | 22   |
| 4.4.4   | 8-Channel Model User Interface Overview .....               | 25   |
| 4.5     | To Prepare for Use .....                                    | 30   |
| 4.5.1   | To Adjust the Supporting Legs .....                         | 30   |
| 4.5.2   | To Connect to Power .....                                   | 30   |
| 4.5.3   | Turn-on Checkout .....                                      | 31   |
| 4.5.4   | To Set the System Language .....                            | 31   |
| 4.6     | Touch Screen Gestures .....                                 | 32   |
| 4.6.1   | Tap .....                                                   | 32   |
| 4.6.2   | Drag .....                                                  | 32   |
| 4.7     | Parameter Setting Method .....                              | 33   |
| 4.7.1   | To Set Parameters with the Front-panel Keys and Knobs ..... | 33   |
| 4.7.2   | To Set Parameters with the Touch Screen .....               | 36   |
| 4.8     | To Replace the Fuse .....                                   | 38   |

|                                                                  |           |
|------------------------------------------------------------------|-----------|
| 4.9 To Use the Security Lock .....                               | 38        |
| 4.10 To Use the Built-in Help System .....                       | 39        |
| 4.11 To View the Option Information and Install the Option ..... | 39        |
| <b>5 Continuous .....</b>                                        | <b>41</b> |
| 5.1 To Output Sine Wave .....                                    | 42        |
| 5.2 To Output Square Wave .....                                  | 45        |
| 5.3 To Output Ramp Wave .....                                    | 47        |
| 5.4 To Output Pulse .....                                        | 49        |
| 5.5 To Output Noise .....                                        | 51        |
| 5.6 To Output DC .....                                           | 52        |
| 5.7 To Output Arbitrary Waveforms .....                          | 53        |
| 5.8 To Output Harmonic .....                                     | 60        |
| <b>6 Modulation .....</b>                                        | <b>64</b> |
| 6.1 Amplitude Modulation (AM) .....                              | 65        |
| 6.2 Frequency Modulation (FM) .....                              | 67        |
| 6.3 Phase Modulation (PM) .....                                  | 68        |
| 6.4 Amplitude Shift Keying (ASK) .....                           | 70        |
| 6.5 Frequency Shift Keying (FSK) .....                           | 71        |
| 6.6 Phase Shift Keying (PSK) .....                               | 73        |
| 6.7 Pulse Width Modulation (PWM) .....                           | 74        |
| 6.8 SUM Modulation .....                                         | 76        |
| <b>7 Sweep .....</b>                                             | <b>78</b> |
| 7.1 Sweep Type .....                                             | 78        |
| 7.2 Start Frequency and Stop Frequency .....                     | 80        |
| 7.3 Center Frequency and Frequency Span .....                    | 81        |
| 7.4 Sweep Time .....                                             | 82        |
| 7.5 Start/Stop Hold Time .....                                   | 82        |
| 7.6 Return Time .....                                            | 83        |
| 7.7 Sweep Trigger Source .....                                   | 83        |
| 7.8 Mark Frequency .....                                         | 84        |
| <b>8 Burst .....</b>                                             | <b>85</b> |
| 8.1 Burst Type .....                                             | 86        |
| 8.2 Burst Delay .....                                            | 87        |
| 8.3 Burst Phase .....                                            | 87        |
| 8.4 Burst Period .....                                           | 88        |
| 8.5 Burst Trigger Source .....                                   | 88        |
| 8.6 Gated Polarity .....                                         | 89        |

|                                           |            |
|-------------------------------------------|------------|
| 8.7 Idle Level                            | 89         |
| <b>9 Advanced Mode</b>                    | <b>91</b>  |
| 9.1 Arb                                   | 91         |
| 9.2 Sequence (Optional)                   | 93         |
| 9.2.1 New Sequence                        | 94         |
| 9.2.2 Output Rules                        | 96         |
| 9.2.3 To Save/Load Sequence               | 98         |
| 9.2.4 To Set Sequence Parameters          | 99         |
| 9.3 PRBS                                  | 100        |
| 9.4 Multi-pulse (Optional)                | 102        |
| 9.5 Multi-tone(Optional)                  | 105        |
| 9.6 Pattern (Optional)                    | 107        |
| 9.7 IQ Waveform (Optional)                | 111        |
| <b>10 Arb Build</b>                       | <b>115</b> |
| <b>11 Channel Setup</b>                   | <b>118</b> |
| 11.1 Sync Signal Setup                    | 118        |
| 11.2 Trigger Output Setup                 | 121        |
| 11.3 Channel Output Setup                 | 121        |
| <b>12 Channel Copy</b>                    | <b>124</b> |
| <b>13 Bundle By Source Setup</b>          | <b>128</b> |
| 13.1 Coupling Setup                       | 129        |
| 13.2 Channel Track                        | 132        |
| <b>14 Align Phase</b>                     | <b>134</b> |
| <b>15 Storage Management</b>              | <b>135</b> |
| 15.1 To Select the File                   | 135        |
| 15.2 To Transfer Files with FTP           | 136        |
| 15.3 To Create New Folder                 | 138        |
| 15.4 Cut and Copy                         | 138        |
| 15.5 Rename                               | 138        |
| 15.6 Delete                               | 138        |
| <b>16 Upgrade</b>                         | <b>139</b> |
| <b>17 System Utility Function Setting</b> | <b>140</b> |
| 17.1 I/O Setting                          | 140        |
| 17.2 LXI                                  | 142        |
| 17.3 Basic Settings                       | 142        |
| 17.4 About this Instrument                | 145        |
| 17.5 Print Screen                         | 145        |

---

|                                                |     |
|------------------------------------------------|-----|
| 17.6 Option .....                              | 146 |
| 17.7 Open Source Acknowledgment .....          | 146 |
| 17.8 Self-check .....                          | 146 |
| 18 Preset Function .....                       | 147 |
| 19 Remote Control .....                        | 153 |
| 19.1 Remote Control via USB .....              | 154 |
| 19.2 Remote Control via LAN .....              | 154 |
| 20 Troubleshooting .....                       | 156 |
| 21 Appendix .....                              | 158 |
| 21.1 Appendix A: Options and Accessories ..... | 158 |
| 21.2 Appendix B: Warranty .....                | 159 |

# List of Figures

|                                                                                   |    |
|-----------------------------------------------------------------------------------|----|
| Figure 4.1 DG5508 Pro Front Panel .....                                           | 12 |
| Figure 4.2 Rear Panel .....                                                       | 12 |
| Figure 4.3 Front View .....                                                       | 13 |
| Figure 4.4 Side View .....                                                        | 13 |
| Figure 4.5 Front Panel (8-channel) .....                                          | 14 |
| Figure 4.6 Front Panel (4-channel) .....                                          | 15 |
| Figure 4.7 Front Panel (2-channel) .....                                          | 15 |
| Figure 4.8 Rear Panel .....                                                       | 20 |
| Figure 4.9 2-Channel Model User Interface .....                                   | 22 |
| Figure 4.10 4-Channel Model User Interface .....                                  | 23 |
| Figure 4.11 8-Channel Model User Interface - Single-Channel Display Mode<br>..... | 25 |
| Figure 4.12 8-Channel Model User Interface - 2-Channel Display Mode .....         | 26 |
| Figure 4.13 8-Channel Model User Interface - 4-Channel Display Mode .....         | 26 |
| Figure 4.14 8-Channel Model User Interface - 8-Channel Display Mode .....         | 27 |
| Figure 4.15 8-Channel Display Mode Parameter Setting Interface .....              | 28 |
| Figure 4.16 Adjust the Supporting Legs .....                                      | 30 |
| Figure 4.17 Connect to Power .....                                                | 31 |
| Figure 4.18 Tap Gesture .....                                                     | 32 |
| Figure 4.19 Drag Gesture .....                                                    | 33 |
| Figure 4.20 String Keypad .....                                                   | 36 |
| Figure 4.21 Numeric Keypad .....                                                  | 37 |
| Figure 4.22 Replace the Fuse .....                                                | 38 |
| Figure 4.23 Use the Security Lock .....                                           | 39 |
| Figure 5.1 Continuous Setting Interface .....                                     | 41 |
| Figure 5.2 Harmonic Setting Interface .....                                       | 61 |
| Figure 5.3 Table Editing Menu .....                                               | 63 |

|                                                        |     |
|--------------------------------------------------------|-----|
| Figure 6.1 Modulation Setting Interface .....          | 64  |
| Figure 7.1 Sweep Setting Interface .....               | 78  |
| Figure 7.2 Linear Sweep .....                          | 79  |
| Figure 7.3 Logarithmic Sweep .....                     | 79  |
| Figure 7.4 Step Sweep .....                            | 80  |
| Figure 7.5 Sweep .....                                 | 82  |
| Figure 8.1 Burst Setting Interface .....               | 85  |
| Figure 9.1 Advanced Waveform Setting Interface .....   | 91  |
| Figure 9.2 Arb Setting Interface (Advanced Mode) ..... | 92  |
| Figure 9.3 Sequence Setting Interface .....            | 94  |
| Figure 9.4 Sequence Editing Table .....                | 94  |
| Figure 9.6 PRBS Setting Interface .....                | 101 |
| Figure 9.7 Multi-pulse Setting Interface .....         | 103 |
| Figure 9.8 Multi-pulse Setting Menu .....              | 103 |
| Figure 9.9 Multi-tone Setting Interface .....          | 106 |
| Figure 9.10 Multi-tone Setting Menu .....              | 106 |
| Figure 9.11 Pattern Setting Interface .....            | 108 |
| Figure 9.12 Pattern Setting Menu .....                 | 108 |
| Figure 9.13 Block Diagram of IQ Modulation .....       | 111 |
| Figure 9.14 IQ Setting Interface .....                 | 111 |
| Figure 9.15 IQ Setting Menu .....                      | 112 |
| Figure 10.1 Arb Build Interface .....                  | 115 |
| Figure 11.1 Channel Setup Interface .....              | 118 |
| Figure 12.1 Channel Copy Menu .....                    | 124 |
| Figure 13.1 Bundle By Source Menu .....                | 128 |
| Figure 13.2 Coupling Setup Interface .....             | 130 |
| Figure 13.3 Channel Track Setup Interface .....        | 133 |
| Figure 14.1 Before Aligning Phase .....                | 134 |
| Figure 14.2 After Aligning Phase .....                 | 134 |



---

|                                  |     |
|----------------------------------|-----|
| Figure 15.1 Create Session ..... | 137 |
| Figure 18.1 Preset Menu .....    | 147 |

# List of Tables

|                                                                            |     |
|----------------------------------------------------------------------------|-----|
| Table 5.1 Range of Continuous Waveform Frequency .....                     | 41  |
| Table 5.2 Range of Amplitude .....                                         | 42  |
| Table 5.4 Built-in Waveforms .....                                         | 54  |
| Table 6.1 Carrier Frequency Range (Modulation Mode) .....                  | 65  |
| Table 7.1 Sweep Start/Stop Frequency Range .....                           | 80  |
| Table 8.1 Carrier Frequency Range (Burst Mode) .....                       | 86  |
| Table 9.1 PRBS Polynomial Expression .....                                 | 100 |
| Table 9.2 Pattern Preset Amplitude (HighZ) .....                           | 109 |
| Table 11.1 Sync Signal of Different Output Modes (Positive Polarity) ..... | 119 |
| Table 12.1 Multi-channel Operation Parameters .....                        | 124 |
| Table 18.1 Factory Settings .....                                          | 148 |

# 1 Safety Requirement

---

## 1.1 General Safety Summary

---

Please review the following safety precautions carefully before putting the instrument into operation so as to avoid any personal injury or damage to the instrument and any product connected to it. To prevent potential hazards, please follow the instructions specified in this manual to use the instrument properly.

- **Use the BNC Output Connectors Properly.**

The front-panel BNC output connectors only allow signal output but do not support signal input.

- **Use Proper Power Cord.**

Only the exclusive power cord designed for the instrument and authorized for use within the local country could be used.

- **Ground the Instrument.**

The instrument is grounded through the Protective Earth lead of the power cord. To avoid electric shock, it is essential to connect the earth terminal of the power cord to the Protective Earth terminal before connecting any inputs or outputs.

- **Observe All Terminal Ratings.**

To avoid fire or shock hazard, observe all ratings and markers on the instrument and check your manual for more information about ratings before connecting the instrument.

- **Use Proper Overvoltage Protection.**

Ensure that no overvoltage (such as that caused by a bolt of lightning) can reach the product. Otherwise, the operator might be exposed to the danger of an electric shock.

- **Do Not Operate Without Covers.**

Do not operate the instrument with covers or panels removed.

- **Do Not Insert Objects Into the Air Outlet.**

Do not insert anything into the holes of the fan to avoid damaging the instrument.

- **Use Proper Fuse.**

Please use the specified fuses.

- **Avoid Circuit or Wire Exposure.**

Do not touch exposed junctions and components when the unit is powered on.

- **Do Not Operate With Suspected Failures.**

If you suspect damage occurs to the instrument, have it inspected by RIGOL authorized personnel before further operations. Any maintenance, adjustment or replacement especially to circuits or accessories must be performed by RIGOL authorized personnel.
- **Provide Adequate Ventilation.**

Inadequate ventilation may cause an increase of temperature in the instrument, which would cause damage to the instrument. So please keep the instrument well ventilated and inspect the air outlet and the fan regularly.
- **Do Not Operate in Wet Conditions.**

To avoid short circuit inside the instrument or electric shock, never operate the instrument in a humid environment.
- **Do Not Operate in an Explosive Atmosphere.**

To avoid personal injuries or damage to the instrument, never operate the instrument in an explosive atmosphere.
- **Keep Instrument Surfaces Clean and Dry.**

To avoid dust or moisture from affecting the performance of the instrument, keep the surfaces of the instrument clean and dry.
- **Prevent Electrostatic Impact.**

Operate the instrument in an electrostatic discharge protective environment to avoid damage induced by static discharges. Always ground both the internal and external conductors of cables to release static before making connections.
- **Use the Battery Properly.**

Do not expose the battery (if available) to high temperature or fire. Keep it out of the reach of children. Improper change of a battery (lithium battery) may cause an explosion. Use the RIGOL specified battery only.
- **Handle with Caution.**

Please handle with care during transportation to avoid damage to keys, knobs, interfaces, and other parts on the panels.

**WARNING**

**Equipment meeting Class A requirements may not offer adequate protection to broadcast services within residential environment.**

## 1.2 Safety Notices and Symbols

### Safety Notices in this Manual:



#### **WARNING**

Indicates a potentially hazardous situation or practice which, if not avoided, will result in serious injury or death.



#### **CAUTION**

Indicates a potentially hazardous situation or practice which, if not avoided, could result in damage to the product or loss of important data.

### Safety Notices on the Product:

- **DANGER**  
It calls attention to an operation, if not correctly performed, could result in injury or hazard immediately.
- **WARNING**  
It calls attention to an operation, if not correctly performed, could result in potential injury or hazard.
- **CAUTION**  
It calls attention to an operation, if not correctly performed, could result in damage to the product or other devices connected to the product.

### Safety Symbols on the Product:



**Hazardous Voltage**



**Safety Warning**



**Protective Earth Terminal**

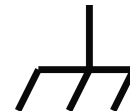

**Chassis Ground**



**Test Ground**

## 1.3 Measurement Category

### Measurement Category

This instrument can make measurements in Measurement Category I.



#### **WARNING**

This instrument can only be used for measurements within its specified measurement categories.

## Measurement Category Definitions

- **Measurement category I** is for measurements performed on circuits not directly connected to MAINS. Examples are measurements on circuits not derived from MAINS, and specially protected (internal) MAINS derived circuits. In the latter case, transient stresses are variable. Thus, you must know the transient withstand capability of the equipment.
- **Measurement category II** is for measurements performed on circuits directly connected to low voltage installation. Examples are measurements on household appliances, portable tools and similar equipment.
- **Measurement category III** is for measurements performed in the building installation. Examples are measurements on distribution boards, circuit-breakers, wiring (including cables, bus-bars, junction boxes, switches and socket-outlets) in the fixed installation, and equipment for industrial use and some other equipment. For example, stationary motors with permanent connection to a fixed installation.
- **Measurement category IV** is for measurements performed at the source of a low-voltage installation. Examples are electricity meters and measurements on primary overcurrent protection devices and ripple control units.

## 1.4 Ventilation Requirement

This instrument uses a fan to force cooling. Please make sure that the air inlet and outlet areas are free from obstructions and have free air. When using the instrument in a bench-top or rack setting, provide at least 10 cm clearance beside, above and behind the instrument for adequate ventilation.



### CAUTION

Inadequate ventilation may cause an increase of temperature in the instrument, which would cause damage to the instrument. So please keep the instrument well ventilated and inspect the air outlet and the fan regularly.

## 1.5 Working Environment

### Temperature

Operating: 0°C to +40°C

Non-operating: -20°C to +60°C

### Humidity

- **Operating:**  
0°C to +40°C: ≤80% RH (without condensation)

- **Non-operating:**  
-20°C to +40°C: ≤90% RH (without condensation)  
Below +60°C: ≤80% RH (without condensation)



### WARNING

**To avoid short circuit inside the instrument or electric shock, never operate the instrument in a humid environment.**

### Altitude

- **Operating:** below 3 km
- **Non-operating:** below 12 km

### Protection Level Against Electric Shock

ESD ±8kV

### Installation (Overvoltage) Category

This product is powered by mains conforming to installation (overvoltage) category II.



### WARNING

**Ensure that no overvoltage (such as that caused by a bolt of lightning) can reach the product. Otherwise, the operator might be exposed to the danger of an electric shock.**

### Installation (Overvoltage) Category Definitions

Installation (overvoltage) category I refers to signal level which is applicable to equipment measurement terminals connected to the source circuit. Among these terminals, precautions are done to limit the transient voltage to a low level.

Installation (overvoltage) category II refers to the local power distribution level which is applicable to equipment connected to the AC line (AC power).

### Pollution Degree

Pollution Degree 2

### Pollution Degree Definition

- **Pollution Degree 1:** No pollution or only dry, nonconductive pollution occurs. The pollution has no effect. For example, a clean room or air-conditioned office environment.
- **Pollution Degree 2:** Normally only nonconductive pollution occurs. Temporary conductivity caused by condensation is to be expected. For example, indoor environment.

- **Pollution Degree 3:** Conductive pollution or dry nonconductive pollution that becomes conductive due to condensation occurs. For example, sheltered outdoor environment.
- **Pollution Degree 4:** The pollution generates persistent conductivity caused by conductive dust, rain, or snow. For example, outdoor areas.

### Safety Class

Class 1 – Grounded Product

## 1.6 Care and Cleaning

### Care

Do not store or leave the instrument where it may be exposed to direct sunlight for long periods of time.

### Cleaning

Clean the instrument regularly according to its operating conditions.

1. Disconnect the instrument from all power sources.
2. Clean the external surfaces of the instrument with a soft cloth dampened with mild detergent or water. Avoid having any water or other objects into the chassis via the heat dissipation hole. When cleaning the LCD, take care to avoid scarifying it.

### CAUTION

To avoid damage to the instrument, do not expose it to caustic liquids.



### WARNING

To avoid short-circuit resulting from moisture or personal injuries, ensure that the instrument is completely dry before connecting it to the power supply.



## 1.7 Environmental Considerations

The following symbol indicates that this product complies with the WEEE Directive 2012/19/EU.



The equipment may contain substances that could be harmful to the environment or human health. To avoid the release of such substances into the environment and avoid harm to human health, we recommend you to recycle this product



appropriately to ensure that most materials are reused or recycled properly. Please contact your local authorities for disposal or recycling information.

You can click on the following link <https://int.rigol.com/services/services/declaration> to download the latest version of the RoHS&WEEE certification file.

## 2 Product Features

---

### Product Features

- 2/4/8-channel output, isolated from the ground
- Max. sample rate: 2.5 GSa/s
- Max. output frequency: 500 MHz
- Vertical resolution: 16 bits
- Square: 170 MHz max. frequency, 0.8 ns min. rise time
- Pulse: 120 MHz max. frequency, 4.2 ns min. pulse width
- Built-in high-order harmonic generator (max. 20th order)
- A maximum Arb waveform length of 64 Mpts/CH (128 Mpts/CH optional)
- Optional functions: Sequence, IQ, Multi-pulse, Pattern, Multi-tone
- 10.1" HD touch screen, allowing you to configure multi-channel waveforms together from a single screen
- Standard Web Control function for easier remote cooperation

---

With up to 2.5 GSa/s sample rate and 64 Mpts/CH memory depth (128 Mpts/CH optional), the DG5000 Pro Series Function/Arbitrary Waveform Generator is an all-in-one generator that integrates Function Generator, Arbitrary Waveform Generator, Noise Generator, Pulse Generator, Harmonics Generator, and Analog/Digital Modulator. It is a multi-functional and cost-effective multi-channel function/arbitrary waveform generator.

---

## 3 Document Overview

This manual gives you a quick overview of the front and rear panels, user interface as well as basic operation methods of the DG5000 Pro Series Function/Arbitrary Waveform Generator.



### TIP

For the latest version of this manual, download it from RIGOL official website ([www.rigol.com](http://www.rigol.com)).

### Publication Number

UGB18101-1110

### Software Version

00.01.01

Software upgrade might change or add product features. Please acquire the latest version of the manual from RIGOL website or contact RIGOL to upgrade the software.

### Format Conventions in this Manual

#### 1. Key

The front panel key is denoted by the menu key icon. For example,  indicates the "Default" key.

#### 2. Menu

The menu item is denoted by the format of "Menu Name (Bold) + Character Shading" in the manual. For example, **Setup**.

#### 3. Operation Procedures

The next step of the operation is denoted by ">" in the manual. For example, .

> **Utility** indicates first clicking or tapping  and then clicking or tapping **Utility**.

### Content Conventions in this Manual

DG5000 Pro Series Function/Arbitrary Waveform Generator includes the following models. Unless otherwise specified, this manual takes DG5508 Pro as an example to illustrate the basic operation methods of DG5000 Pro series.

| Model      | No. of Channels | Sample Rate | Max. Output Frequency |
|------------|-----------------|-------------|-----------------------|
| DG5252 Pro | 2               | 2.5 GSa/s   | 250 MHz               |
| DG5254 Pro | 4               | 2.5 GSa/s   | 250 MHz               |

| Model      | No. of Channels | Sample Rate | Max. Output Frequency |
|------------|-----------------|-------------|-----------------------|
| DG5258 Pro | 8               | 2.5 GSa/s   | 250 MHz               |
| DG5352 Pro | 2               | 2.5 GSa/s   | 350 MHz               |
| DG5354 Pro | 4               | 2.5 GSa/s   | 350 MHz               |
| DG5358 Pro | 8               | 2.5 GSa/s   | 350 MHz               |
| DG5502 Pro | 2               | 2.5 GSa/s   | 500 MHz               |
| DG5504 Pro | 4               | 2.5 GSa/s   | 500 MHz               |
| DG5508 Pro | 8               | 2.5 GSa/s   | 500 MHz               |

## 4 Quick Start

---

### 4.1 General Inspection

---

#### 1. Inspect the packaging

If the packaging has been damaged, do not dispose the damaged packaging or cushioning materials until the shipment has been checked for completeness and has passed both electrical and mechanical tests.

The consigner or carrier shall be liable for the damage to the instrument resulting from shipment. RIGOL would not be responsible for free maintenance/rework or replacement of the instrument.

#### 2. Inspect the instrument

In case of any mechanical damage, missing parts, or failure in passing the electrical and mechanical tests, contact your RIGOL sales representative.

#### 3. Check the accessories

Please check the accessories according to the packing lists. If the accessories are damaged or incomplete, please contact your RIGOL sales representative.

#### Recommended Calibration Interval

RIGOL suggests that the instrument should be calibrated every 12 months.

## 4.2 Appearance

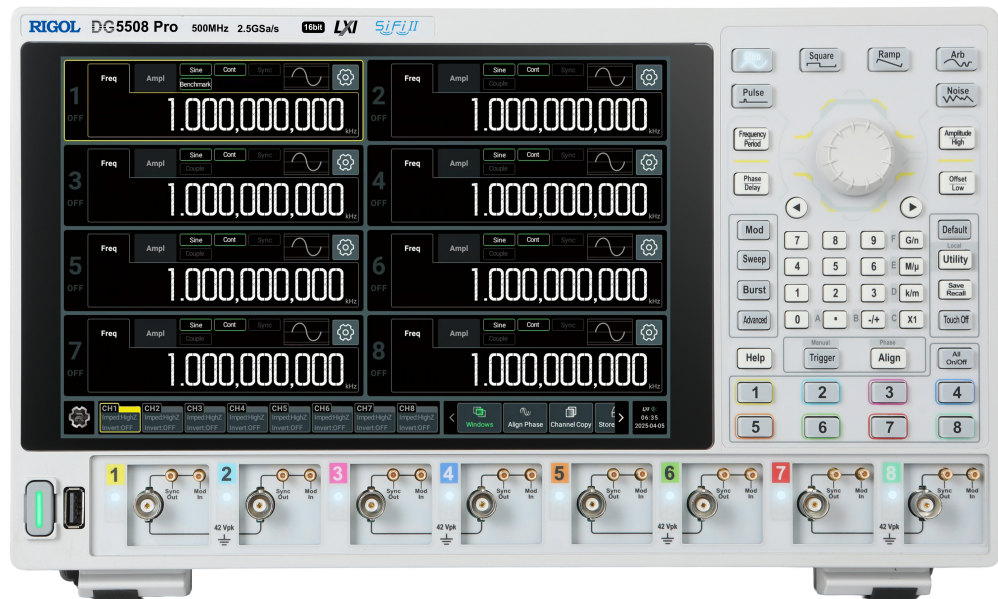

Figure 4.1 DG5508 Pro Front Panel



Figure 4.2 Rear Panel

### 4.3 Dimensions

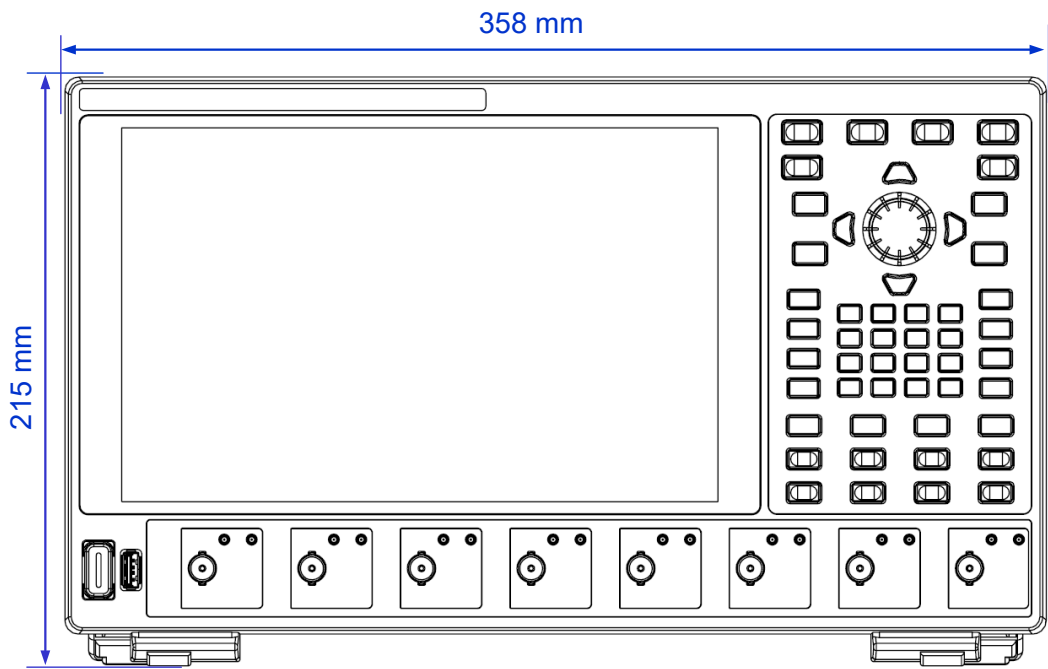

Figure 4.3 Front View

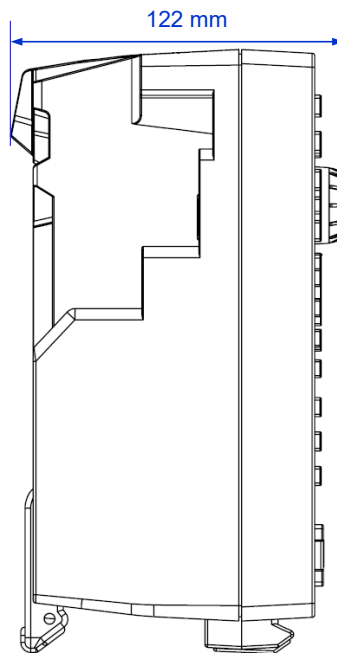

Figure 4.4 Side View

## 4.4 Product Overview

This chapter introduces the appearance and dimensions, front and rear panels as well as the user interface (display) of the DG5000 Pro series.

### 4.4.1 Front Panel Overview

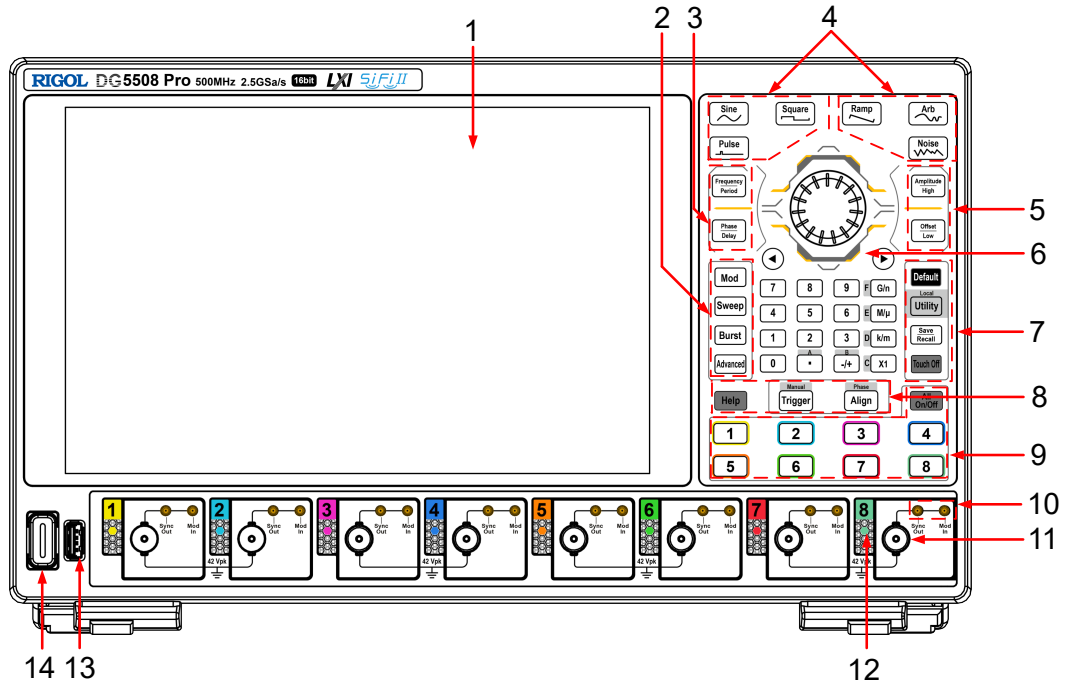

Figure 4.5 Front Panel (8-channel)



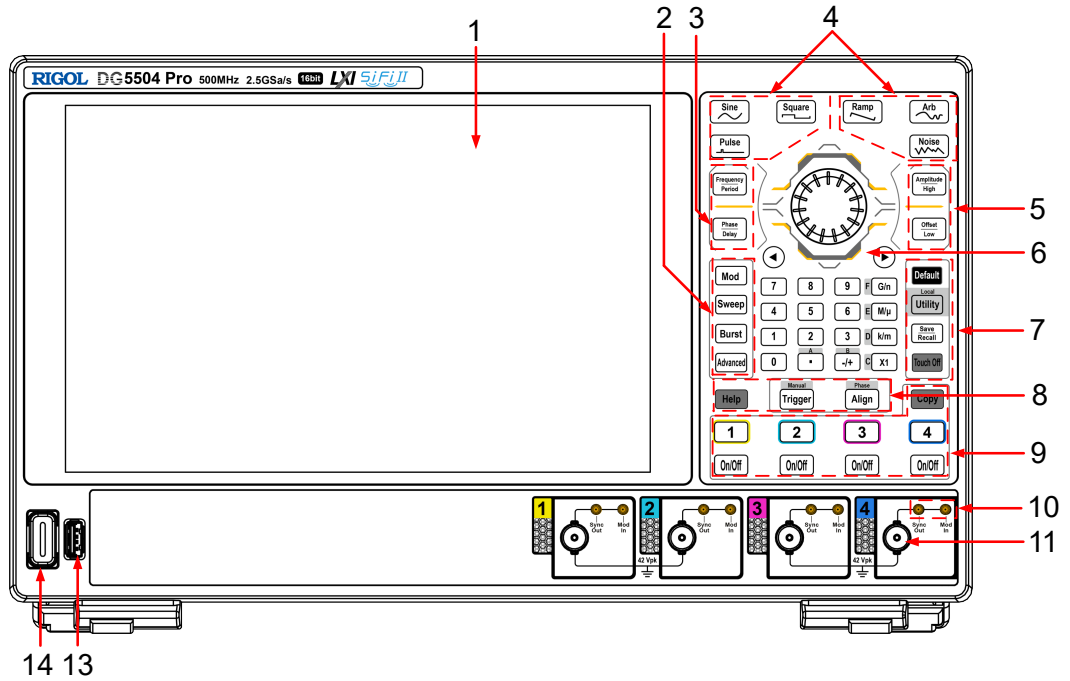

Figure 4.6 Front Panel (4-channel)

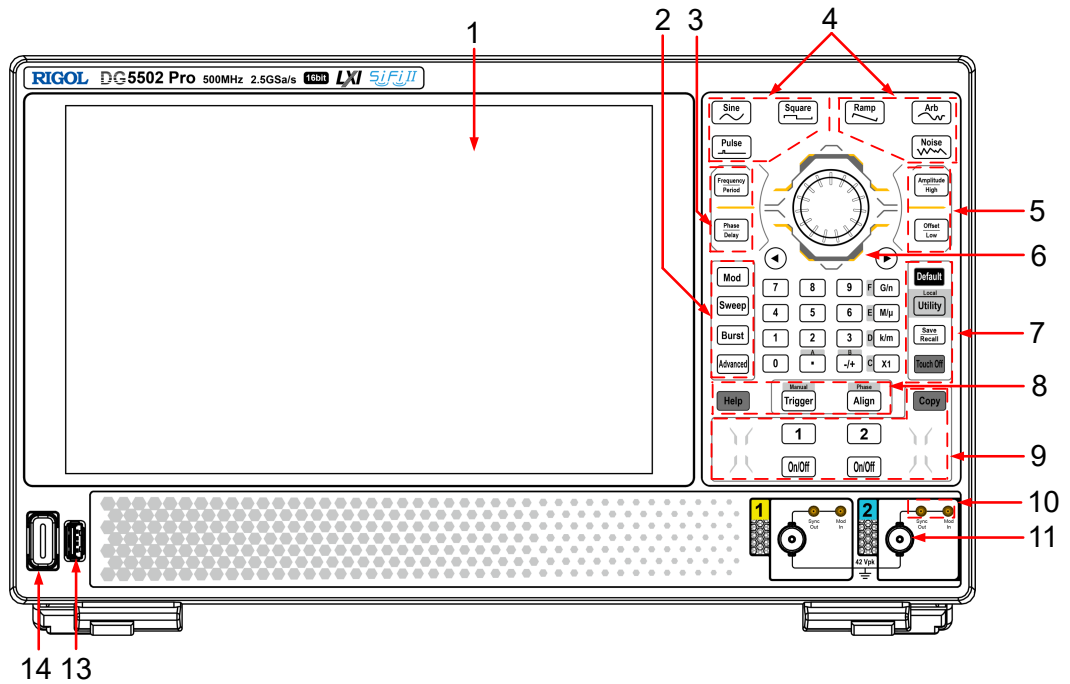





Figure 4.7 Front Panel (2-channel)



**1. 10.1-inch Touch Screen**

Displays the menu labels, parameter settings, system state, prompt messages, and other information.



**2. Output Mode Selection Area**



- : Modulation key. Press the key to set the output mode to Modulation or Continuous for the current channel. For details about the Modulation mode, please refer to *Modulation*.
- : Sweep key. Press the key to set the output mode to Sweep or Continuous for the current channel. For details about the Sweep mode, please refer to *Sweep*.
- : Burst key. Press the key to set the output mode to Burst or Continuous for the current channel. For details about the Burst mode, please refer to *Burst*.
- : Advanced mode key. Press the key to set the output mode to Advanced or Continuous for the current channel. For details about Advanced mode, please refer to *Advanced Mode*.

### 3. Frequency/Period and Phase/Delay Keys



- : Frequency/Period key. If the focus cursor is not in the **Frequency/Period** input field, press the key to move the focus to the **Frequency/Period** input field in the Basic Waveform Setting Interface. If the focus cursor is in the **Frequency/Period** input field, press the key to switch the input parameter to Frequency or Period. There is no response when the output mode is set to Sweep or Advanced, the selected basic waveform does not have frequency/period properties, or the focus cursor is on the Channel Setup Interface.
- : Phase/Delay key. In non-Burst mode, press the key to switch the focus cursor to the **Phase** input field in the Basic Waveform Setting Interface. In Burst mode, press the key to switch the focus cursor to the **Phase** or **Delay** input field in the Burst Setting Interface. There is no response when the output mode is set to Sweep or Advanced, the selected basic waveform or the burst sub-mode does not have phase/delay properties.

### 4. Basic Waveform Selection Area

- : Sine key. Press the key to set the basic waveform to Sine for the current channel. For details about the Sine waveform, please refer to *To Output Sine Wave*.
- : Square key. Press the key to set the basic waveform to Square for the current channel. For details about the Square waveform, please refer to *To Output Square Wave*.
- : Pulse key. Press the key to set the basic waveform to Pulse for the current channel. For details about the Pulse waveform, please refer to *To Output Pulse*.

- : Ramp key. Press the key to set the basic waveform to Ramp for the current channel. For details about the Ramp waveform, please refer to *To Output Ramp Wave*.
- : Arb key. Press the key to set the basic waveform to Arb for the current channel. For details about Arb, please refer to *To Output Arbitrary Waveforms*.
- : Noise key. Press the key to set the basic waveform to Noise for the current channel. For details about the Noise, please refer to *To Output Noise*.





## 5. Amplitude/High Level and Offset/Low Level Keys

- : Amplitude/High Level key. If the focus cursor is not in the **Amplitude/High Level** input field, press the key to move the focus to the **Amplitude/High Level** input field. If the focus cursor is in the **Amplitude/High Level** input field, press the key to switch the input parameter to Amplitude or High Level. There is no response when the cursor is in the Channel Setup Interface.
- : Offset/Low Level key. If the focus cursor is not in the **Offset/Low Level** input field, press the key to move the focus to the **Offset/Low Level** input field. If the focus cursor is in the **Offset/Low Level** input field, press the key to switch the input parameter to Offset or Low Level. There is no response when the cursor is in the Channel Setup Interface.

## 6. Parameter Input Area

The parameter input area comprises a knob, arrow keys, and a keyboard. For how to set the parameter using the parameter input area, please refer to *To Set Parameters with the Front-panel Keys and Knobs*.

## 7. Quick Operation Key

- : Default key. Press the key and a dialog box is displayed. Click or tap **OK** or press the key twice to restore the instrument to its factory defaults.
- : Utility/Local key. When the instrument is in local mode, press the key to open/close the Utility menu. When the instrument is in remote control mode, you can press this key to restore the instrument to local operation from remote control.
- : Save/Recall key. Press the key to open or close the Store menu.
- : Touch Off key. Press the key to disable or enable the touch screen function.

## 8. Help Key, Manual Trigger Key, Align Phase Key

- **Help**: Help key. Press the key to open or close the "Help" menu. In this menu, you can get its help information by clicking or tapping the link for the desired item.
- **Trigger**: manual trigger key. When the trigger source is set to manual, the key backlight will be on. At this time, a manually triggered output is generated each time you press the key.
- **Align**: align phase key. Press the key to align phase. For details, refer to *Align Phase*.

## 9. Channel Output Control Area

- **1**, **2** ... **8**: channel selection keys. Press the key to select a specified channel as the current channel. You can set the waveform parameters for the channel with the front-panel keys and knobs. When a channel is selected, the backlight of the corresponding key is illuminated. For 8-channel models, when a specified channel is selected, pressing the corresponding channel selection key can enable or disable the channel output.
- **On/Off**: channel on/off key (for 2-channel/4-channel models). Press the key to enable or disable the corresponding channel output. When the channel output is enabled, the backlight of the corresponding key is illuminated. This key is not available for 8-channel models. The channel on/off key function is multiplexed by the channel selection key.
- **All On/Off**: all channel on/off key (for 8-channel models). Press this key to turn on/off the outputs of 8 channels simultaneously. For 8-channel models, when the channel output is enabled, the indicator of the corresponding output connector is illuminated.
- **Copy**: channel copy key (for 2-channel and 4-channel models). Press this key to open the channel copy menu. You can copy all states and waveforms of one channel to the other one. For details, refer to *Channel Copy*.

## 10. Sync Output/Trigger Output Connector, Modulation Input Connector

DG5252 Pro/DG5352 Pro/DG5502 Pro: two groups

DG5254 Pro/DG5354 Pro/DG5504 Pro: four groups

DG5258 Pro/DG5358 Pro/DG5508 Pro: eight groups

- Sync output/trigger output (Sync Out) connector: SMB connector. When the sync output of the specified channel is enabled, this connector is used to output the sync signal of the corresponding channel. When the trigger output is enabled, this connector is used to output the trigger signal of the

corresponding channel. The sync output and the trigger output cannot be enabled at the same time.

- Modulation input (Mod In) connector: SMB connector. When the output mode is set to Modulation and an external modulation source is selected with the modulation port set to the front port, this connector accepts an external modulation signal.

### 11. Output Connectors

DG5252 Pro/DG5352 Pro/DG5502 Pro: two groups

DG5254 Pro/DG5354 Pro/DG5504 Pro: four groups

DG5258 Pro/DG5358 Pro/DG5508 Pro: eight groups

BNC type connector with 50  $\Omega$  nominal output impedance. When the channel output is enabled, the corresponding output connector outputs the waveform in the current configuration.

### 12. Channel On/Off Indicator Light (for 8-channel Models)

For 8-channel models, each output connector has an output on/off indicator light on its left. When the output of a channel is enabled, the corresponding indicator light is illuminated. Please note that 2-channel/4-channel models do not have such indicators. When the channel output is enabled, the backlight of the corresponding channel on/off key is illuminated.

### 13. USB HOST Interface

Reads the waveform or state files stored in USB; saves the current instrument state or the edited waveform data into USB; or saves the content displayed on the screen to the USB in the format of a captured image. FAT32, NTFS, and exFAT formats are supported.

### 14. Power Key

Powers the signal generator on or off.

## 4.4.2 Rear Panel Overview

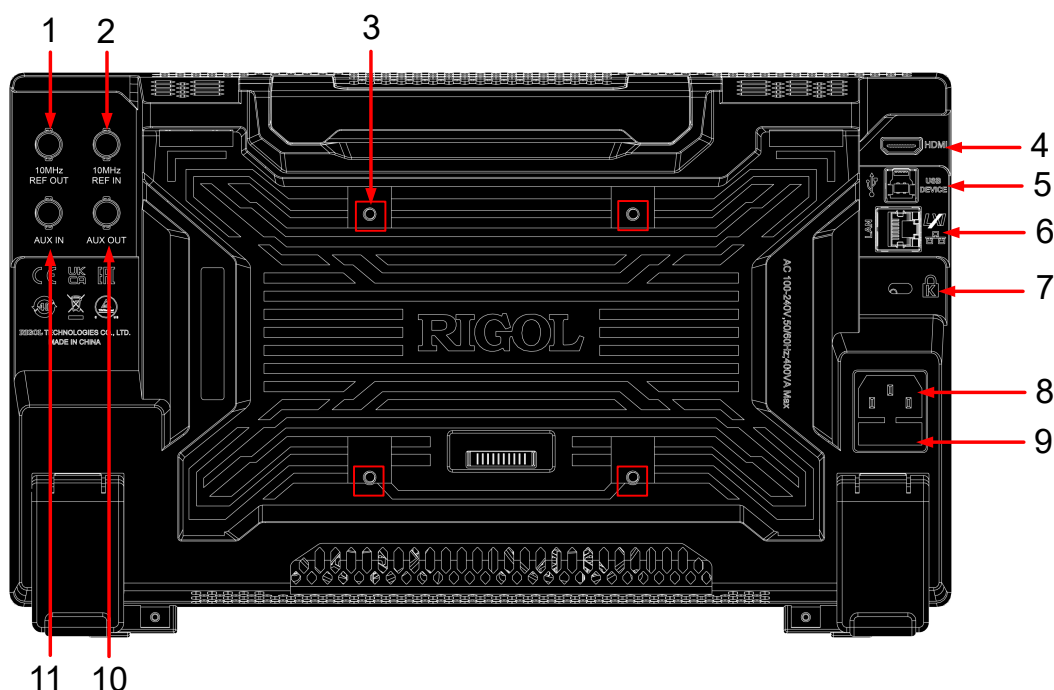

Figure 4.8 Rear Panel

### 1. 10 MHz REF OUT

BNC type connector, can output a 10 MHz clock signal generated by the instrument's internal crystal oscillator.

### 2. 10 MHz REF IN

BNC type connector. When external clock source is selected, this connector accepts an external clock signal.

### 3. Mounting Screw Holes

Interval of screw holes: 100 mm x 100 mm. Use screws (M4\*6-10) to secure the instrument to the bracket with the same screw hole interval.

### 4. HDMI

You can connect the instrument to an external display that has the HDMI port (e.g. monitor or projector) via this interface to have a clear view of the instrument's display. Meanwhile, you can still operate on the instrument's touch screen.

### 5. USB DEVICE

Connect the instrument to the PC via this interface. Then you can use the PC software to send SCPI commands or use the user-defined programming to control the instrument.

### 6. LAN

Connect the instrument to network via this interface. The instrument conforms to LXI CORE 2011 DEVICE instrument standard. Its test system can be built quickly. Then you can control the instrument by using the Web Control, sending SCPI commands via PC software, or using the user-defined programming.

### 7. Security Lock Hole

Use a standard PC/laptop lock cable to secure the instrument to a work bench or other location.

### 8. AC Power Connector

The AC power requirements of the instrument are 100 V to 240 V, 50 Hz/60 Hz. Please use the power cord provided in the accessories to connect the instrument to the AC power source.

### 9. Fuse

If you need to replace the fuse, use only the specified fuse.

### 10. AUX OUT (not used)

It is used for synchronization of multiple instruments.

### 11. AUX IN

BNC type connector. Its function is determined by the current work mode of the channel.

- **Trigger input:** When the channel output mode is set to Sweep, Burst, Sequence, or Multi-pulse and the trigger source is set to External, this connector accepts an external TTL-compatible pulse signal as the trigger input signal.
- **Digital modulation input:** When the channel output is set to ASK/FSK/PSK modulation, the modulation source is set to External, and the modulation port is set to rear port, this connector accepts an external signal as the modulation source.

### 4.4.3 2-Channel/4-Channel Model User Interface Overview

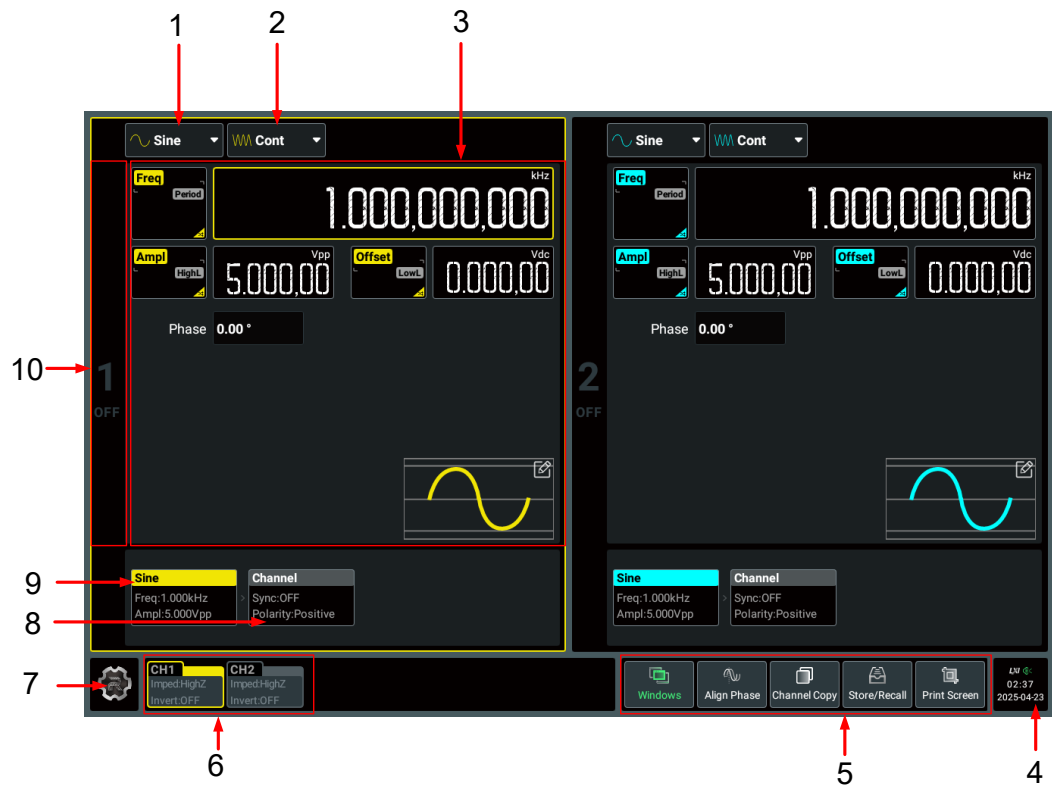

Figure 4.9 2-Channel Model User Interface



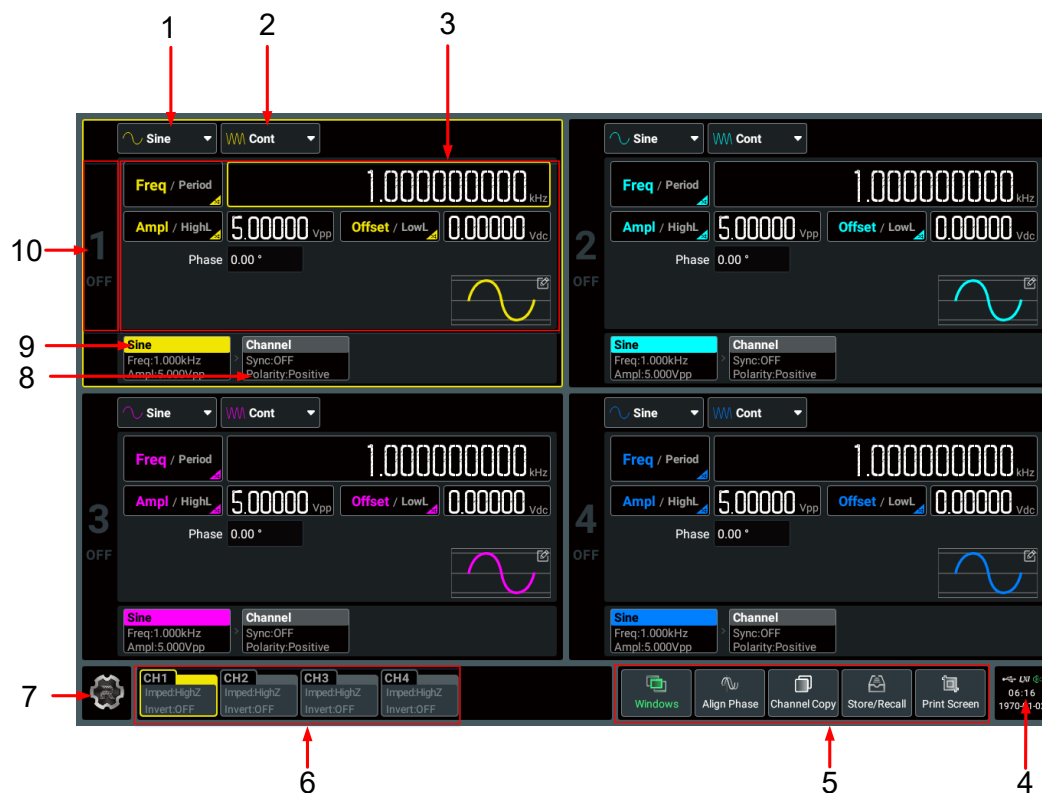

Figure 4.10 4-Channel Model User Interface

### 1. Basic Waveform Drop-down Button

Click or tap the drop-down button to select the waveform type for the specified channel. Available waveform types are related to the current output mode. Note that when the output mode is set to "Advanced", basic waveforms are not available.

### 2. Output Mode Drop-down Button



Click or tap the drop-down button to set the output mode to Continuous, Modulation, Sweep, Burst, or Advanced for the specified channel.



### 3. Parameter Configuration Area

You can set the waveform parameters and channel parameters for the corresponding channel in this area.

### 4. Notification Area

Displays the USB icon, LAN icon, sound icon, and remote control icon. You can click or tap this area to open the "Utility" menu.

- USB storage device icon: When a USB storage device is detected,  will be displayed.
- LAN icon: When the LAN interface is successfully connected,  is displayed.

- Sound icon: In the "Utility" menu, click or tap **Setup** > **Beeper** to enable or disable the sound. When on,  will be displayed; when off,  will be displayed.
- Remote control icon: When the instrument is in remote control mode,  will be displayed.
- Date and Time: When the "Show Time" is set to On, the system date and time will be displayed.

## 5. Function Keys

- Windows key: Click or tap the key to set the display mode to auto mode, single-channel display mode, 2-channel display mode, or 4-channel display mode (4-channel models only).
- Align Phase key: Click or tap the key to perform the phase alignment operation. For details, please refer to [Align Phase](#).
- Channel Copy key: Click or tap this key to open the channel copy menu. You can copy all states and waveforms of one channel to the other one. For details, please refer to [Channel Copy](#).
- Store/Recall key: Click or tap the key to open/close the storage menu.
- Print Screen key: Click or tap this key to capture the current screen and save the picture to internal memory.

## 6. Channel Labels

Display the channel on/off state (the "CH1"/"CH2"/"CH3"/"CH4" illuminated or not), the selected channel (the label highlighted or not), the invert and the impedance setting. You can click or tap the label to select the specified channel. Drag the channel label up to enable the output of the corresponding channel or drag the label down to disable the output of the corresponding channel.

## 7. Function Navigation Icon

Click or tap the icon to open the function navigation menu in which you can access the specified function menu by clicking or tapping the corresponding function key (Utility, Preset, Help, Bundle By Source, Arb Build, Shut Down).

## 8. Channel Tab

Displays the sync on/off status and polarity for the corresponding channel. You can click or tap this tab to switch to the channel setup interface.

## 9. Waveform Tab

Displays the selected continuous waveform type, frequency, and amplitude. You can click or tap this tab to switch to the waveform parameter setting interface.

## 10. Channel Identifier

Identifies the channel number and indicates the on/off state of the channel. You can simply click or tap the area to enable or disable the corresponding channel output.

#### 4.4.4 8-Channel Model User Interface Overview

The 8-channel models of this series support auto display mode, single-channel display mode, and 2-channel/4-channel/8-channel display mode. You can select your desired interface layout based on actual requirements. The user interface in each display mode displays the information for the corresponding number of channels. You can click or tap the **Windows** key at the lower-right of the interface to select different display modes.

##### Auto Display Mode

Selects the display mode automatically based on the number of enabled channels.

##### Single-Channel Display Mode

In single-channel display mode, the interface displays the waveform parameter setting interface and the channel parameter setting interface of one channel. You can click or tap the channel label at the bottom of the interface to select the channel to display. It allows for easier viewing and quick setup of the target channel.

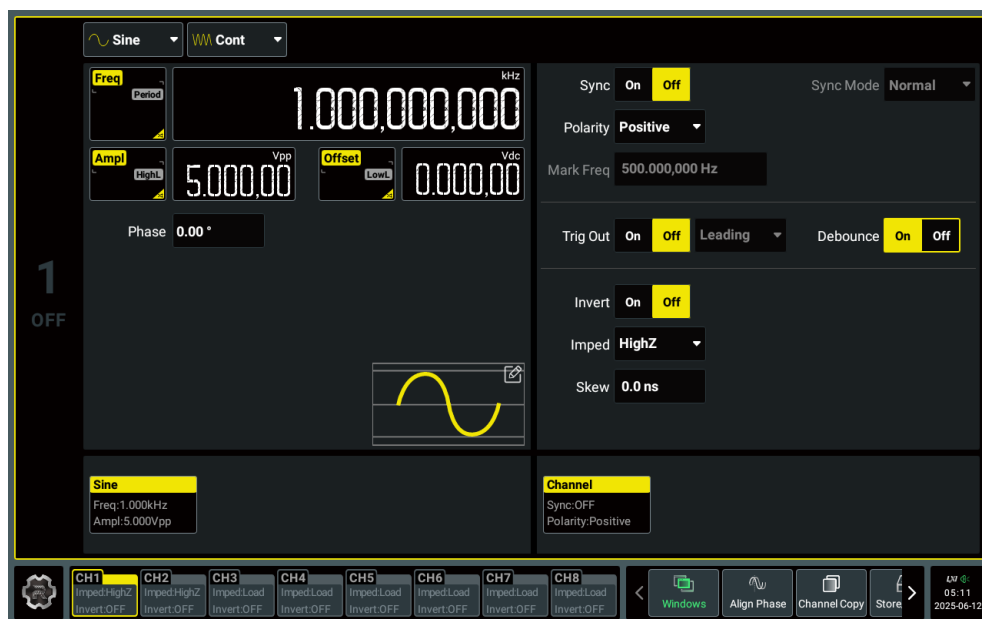

Figure 4.11 8-Channel Model User Interface - Single-Channel Display Mode

##### 2-Channel Display Mode

In 2-channel display mode, the interface only displays the information of two channels. You can click or tap the channel label at the bottom of the interface to select the channel to display. The simple and intuitive interface layout is ideal for application scenarios where an individual channel requires attention.

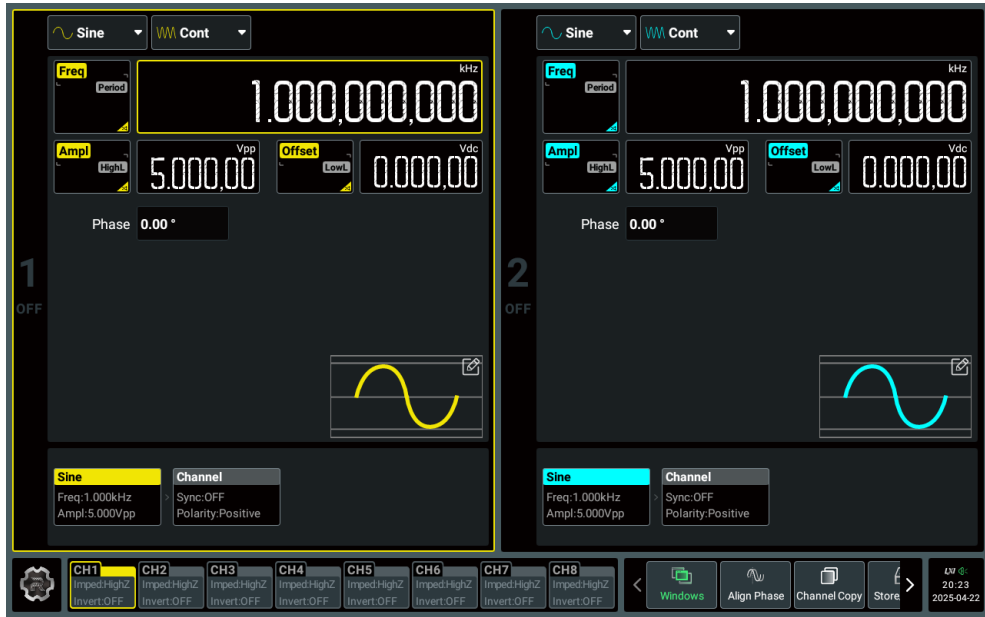

Figure 4.12 8-Channel Model User Interface - 2-Channel Display Mode

### 4-Channel Display Mode

In 4-channel display mode, the interface displays the information of four channels at the same time. You can click or tap the channel label at the bottom of the interface to select the channel to display. This mode offers a balanced display layout to meet the requirements of medium-scale multi-channel testing. It enables simultaneous monitoring and quick setup of multiple channels.

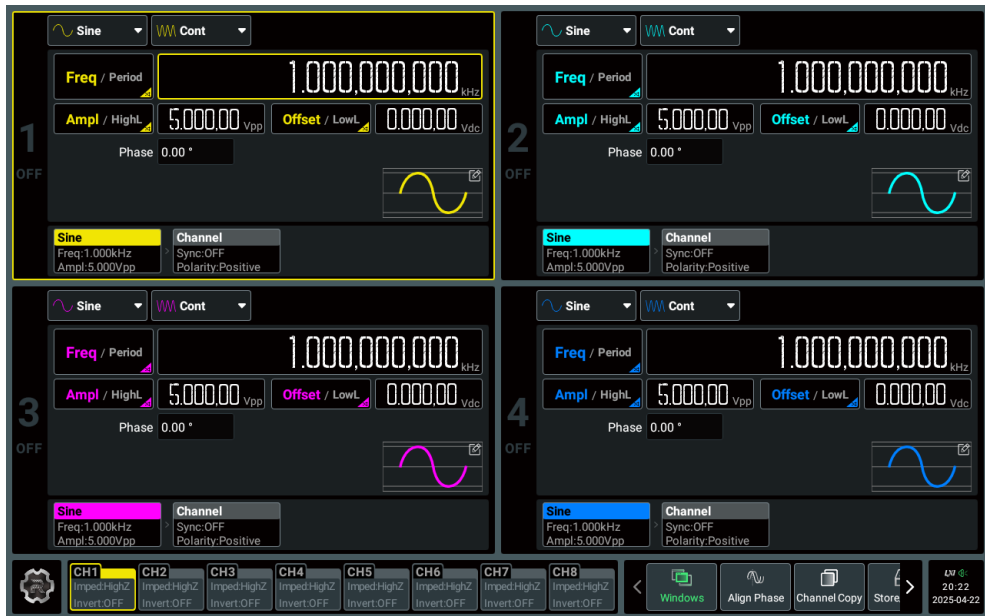



Figure 4.13 8-Channel Model User Interface - 4-Channel Display Mode

## 8-Channel Display Mode

In 8-channel display mode, the interface displays the main information of eight channels (Figure 4.14). The displayed information is related to the current output waveform. This mode is ideal for use in scenarios requiring comprehensive monitoring of channel output parameters, such as multi-channel collaborative testing in complex systems.

Some parameters are not displayed on the main interface in 8-channel display mode. If you need to view or set the complete parameters related to a channel, you can click or tap  on the specified channel configuration area to open the parameter setting interface (Figure 4.15). In 8-channel display mode parameter setting interface, click or tap the channel list on the left or the channel label at the bottom to select different channels for viewing and editing. After editing, click or tap **Back** at the bottom-right of the interface to quit the parameter setting interface.

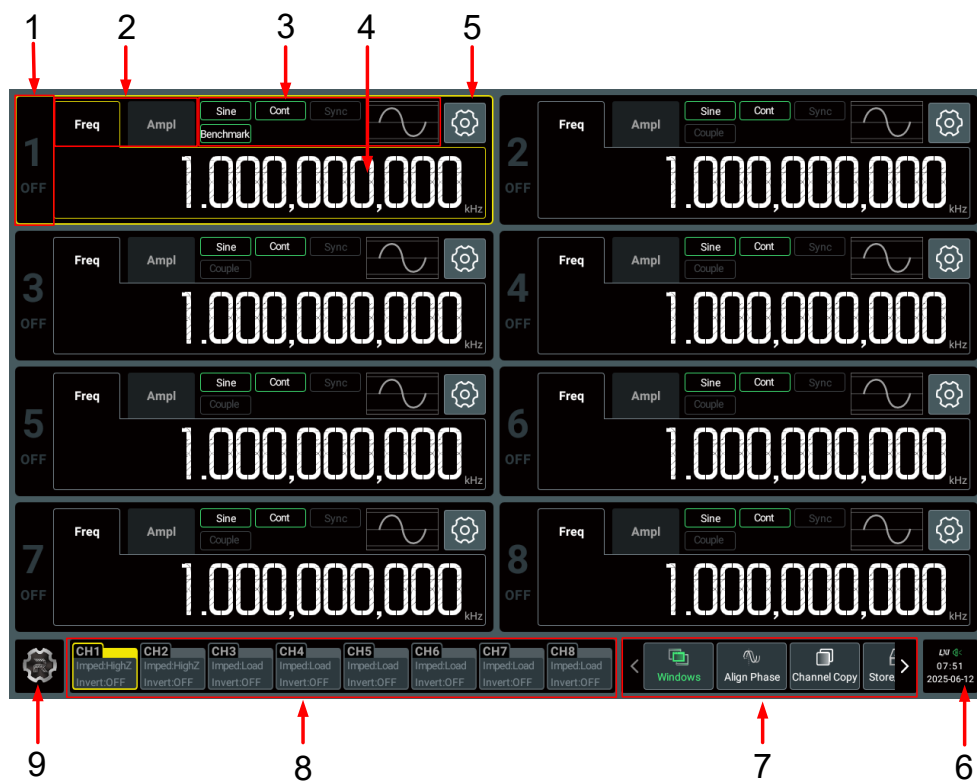
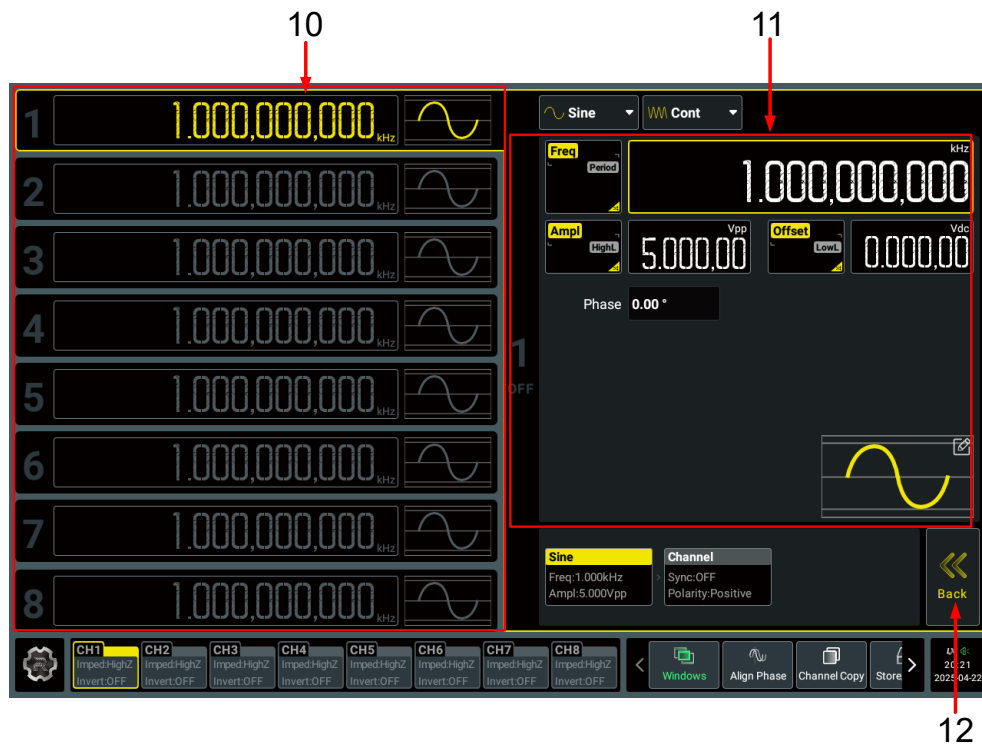

Figure 4.14 8-Channel Model User Interface - 8-Channel Display Mode



**Figure 4.15 8-Channel Display Mode Parameter Setting Interface**

### 1. Channel Identifier

Identifies the channel number (1-8) and indicates the on/off state of the channel. You can simply click or tap the area to enable or disable the corresponding channel output.

### 2. Waveform Parameter Selection Keys

Click or tap the parameter selection key to select the waveform parameter to display for the specified channel. Available waveform parameters are related to the current output waveform.

### 3. Channel Parameter and Waveform Thumbnail Display Area

Displays the selected basic waveform, output mode, sync state, Coupling state, Track state, and trigger source (only when trigger is supported).

### 4. Waveform Parameter Display/Setting Area





Displays the specific value of the selected waveform parameter. Click or tap this area to set this parameter.

### 5. Parameter Setting Key

Click or tap this key to open the parameter configuration interface for the specified channel, as shown in *Figure 4.15*. The parameter configuration interface is displayed at the right side of the screen. You can set the waveform parameters and channel parameters for the corresponding channel in this area. Click or tap **Back** to quit the mode.

## 6. Notification Area

Displays the USB icon, LAN icon, sound icon, and remote control icon. You can click or tap this area to open the "Utility" menu.

- USB storage device icon: When a USB storage device is detected,  will be displayed.
- LAN icon: When the LAN interface is successfully connected,  is displayed.
- Sound icon: In the "Utility" menu, click or tap **Setup** > **Beeper** to enable or disable the sound. When on,  will be displayed; when off,  will be displayed.
- Remote control icon: When the instrument is in remote control mode,  will be displayed.
- Date and Time: When the "Show Time" is set to On, the system date and time will be displayed.

## 7. Function Keys

**Windows**, **Align Phase**, **Channel Copy**, **Store/Recall**, **Print Screen** functions keys are available.

## 8. Channel Labels

Display the channel on/off state of CH1 to CH8 ("CH1", "CH2"... "CH8" illuminated or not), the selected channel (the label is highlighted or not), Invert and Impedance settings. You can click or tap the label to select the specified channel. Drag the channel label up to enable the output of the corresponding channel or drag the label down to disable the output of the corresponding channel.

## 9. Function Navigation Icon

Click or tap the icon to open the function navigation menu in which you can access the specified function menu by clicking or tapping the corresponding function key (Utility, Preset, Help, Bundle By Source, Arb Build, Shut Down).

## 10. Channel List

Displays the brief information of the 8 channels. You can click or tap the specified channel to select the channel and open its parameter configuration interface. The selected channel is highlighted.

## 11. Parameter Configuration Area

In 8-channel mode, it displays all parameters of the selected channel. You can set the parameters for the specified channel in this area.

## 12. Back Key

Click or tap the key to close the channel configuration interface and return to the 8-channel display mode.

## 4.5 To Prepare for Use

### 4.5.1 To Adjust the Supporting Legs

Adjust the supporting legs properly to use them as stands to tilt the instrument upwards for stable placement of the instrument as well as better operation and observation. You can also fold the supporting legs when the instrument is not in use for easier storage or shipment, as shown in the figure below.

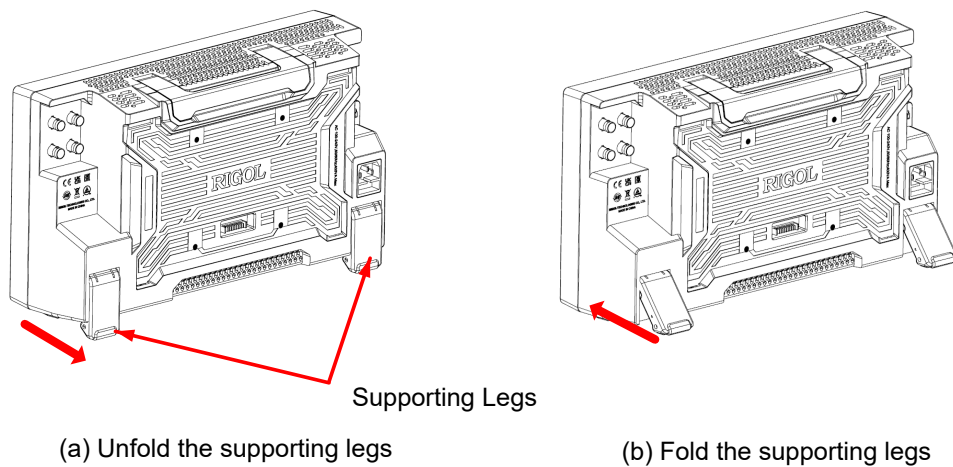
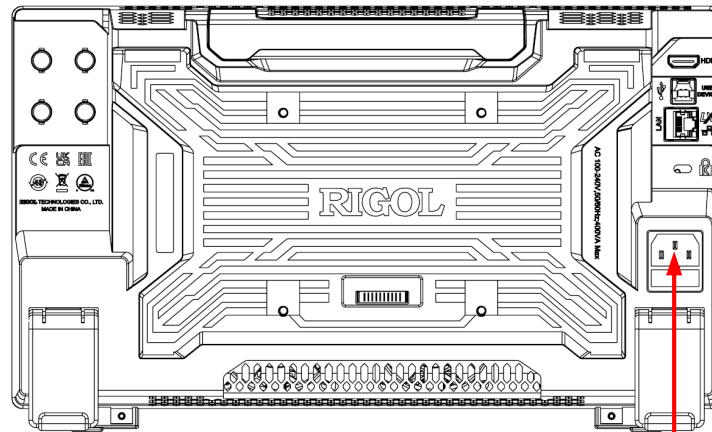

Figure 4.16 Adjust the Supporting Legs

### 4.5.2 To Connect to Power

The power requirements of this signal source are 100 V to 240 V, 50 Hz/60 Hz. Please use the power cord provided in the accessories to connect the instrument to the AC power source, as shown in the figure below.





Power Connector

Figure 4.17 Connect to Power

**WARNING**

To avoid electric shock, please ensure that the instrument is correctly grounded.

### 4.5.3 Turn-on Checkout

After the instrument is connected to the power source, press **0** at the lower-left corner of the front panel to power on the instrument. During the start-up process, the instrument performs a series of self-tests. After the self-test, the splash screen is displayed. You can also click or tap  > **Utility** > **Setup** to set the "Power Set" to "Auto". The instrument powers on once connected to power.

**TIP**

You can shut down the instrument in the following ways.

- Click or tap  > **Shut Down** or press the front-panel **0** and a dialog box "Do you need to shut down the instrument?" is displayed. Click or tap **Shut Down** to shut down the instrument.
- Press **0** twice to shut down the instrument.
- Press **0** for three seconds to shut down the instrument.

### 4.5.4 To Set the System Language

The instrument supports system languages including Chinese and English. You can click or tap  > **Utility** > **Setup** to enter the basic settings menu. Then click or tap

the **Language** drop-down button to set the system language to "Simplified Chinese", "Traditional Chinese", or "English".

## 4.6 Touch Screen Gestures

The instrument provides a capacitive touch screen, which is convenient for you to operate and make configurations. It features great convenience, high flexibility, and great sensitivity. The actions supported by the touch screen controls include tapping and dragging.

### 4.6.1 Tap

Use one finger to tap the symbol or characters on the screen slightly, as shown in *Figure 4.18*. With the Tap gesture, you can perform the following operations:

- Tap the menu displayed on the screen to operate on the menu.
- Tap the function navigation icon at the lower-left corner of the touch screen to enable the function navigation.
- Tap the displayed numeric keypad to set the parameters.
- Tap the virtual keypad to set the filename.
- Tap the close button at the upper-right corner of the message box to close the prompt window.
- Tap other windows on the touch screen and operate on the windows.



**Figure 4.18 Tap Gesture**

### 4.6.2 Drag

Use one finger to select the object, and then drag the object to a destination place, as shown in *Figure 4.19*. With the drag gesture, you can perform the following operations:

- Drag the window controls to change the position of the window (e.g. numeric keypad).
- Drag the cursor of the Arb Build function to change the position of the cursor.
- Drag the channel label to enable or disable the channel output.

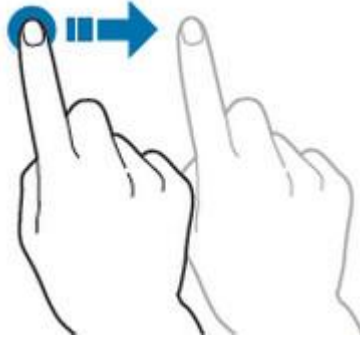

Figure 4.19 Drag Gesture

## 4.7 Parameter Setting Method

This instrument allows you to use the front-panel parameter input area and the touch screen to set parameters for the instrument.



### NOTE

This manual mainly introduces how to set the parameters using the touch screen.

### 4.7.1 To Set Parameters with the Front-panel Keys and Knobs

You can use the front-panel parameter input area to set some parameters of the instrument. The parameter input area consists of a knob, a numeric keyboard, unit selection keys, and arrow keys, as shown in the figure below.





## Knob



You can rotate the knob to move the cursor and navigate through the menu items. Then perform the following operations:

- **If the cursor selects a parameter input field**, you can press the knob to enter the parameter editing mode. You can use the arrow keys to move the cursor. When the cursor selects the digit place, rotate the knob to make the value at the cursor +1 (clockwise) or -1 (counter-clockwise). When the cursor selects the unit, rotate the knob to make the parameter overall  $\times 10$  (clockwise) or  $\div 10$  (counter-clockwise). Press the knob again to confirm the parameter setting and disable the parameter editing mode.
- **If the cursor selects a drop-down button**, you can press the knob to expand the drop-down menu and then rotate the knob to select a parameter in the menu. After that, press the knob again to confirm your selection and collapse the drop-down menu.
- **If the cursor selects a key, on/off switch, or tab control**, pressing the knob is equivalent to tapping the corresponding key, on/off switch, or tab control using the touch screen.







## Numeric Keyboard

The numeric keyboard is composed of numeric keys (from 0 to 9), the decimal point, and symbol keys. If the current cursor selects the input field, you can press the numeric key to input a number; press <sup>A</sup>  to input "."; press <sup>B</sup>  to input "-" or "+". When using the numeric keyboard, you can also perform the following operations:

- Press the knob to confirm the input.













- Press  to delete characters.
- Press  to cancel the input.

**TIP**

When inputting hexadecimal characters, use <sup>A</sup> , <sup>B</sup> , <sup>C</sup> , <sup>D</sup> , <sup>E</sup> , or <sup>F</sup>  to input "A", "B", "C", "D", "E", or "F" respectively.

**Unit Selection Keys**



When setting a parameter with the numeric keyboard on the front panel, you can use the keys to select the unit of the parameter.

- <sup>C</sup> : sets the parameter unit to the default one. For example, when setting the phase, press  > <sup>C</sup>  to set the phase to 1°; when setting the frequency, press  > <sup>C</sup>  to set the frequency to 1 Hz.
- <sup>D</sup> , <sup>E</sup> , <sup>F</sup> : when setting the frequency/impedance, use the unit (k/M/G) before "/"; when setting the time/amplitude/offset, use the unit (m/μ/n) after "/". For example, when setting the frequency, press  > <sup>D</sup>  to set the frequency to 1 kHz; when setting the period, press  > <sup>D</sup>  to set the period to 1 ms.

**TIP**

When the set value exceeds the limit value, the instrument automatically adjusts the parameter to meet the requirements.

**Arrow keys**

- In normal mode, you can use the keys to move the cursor to select the desired menu item. It is equivalent to rotating the knob.
- In parameter editing mode, you can use the keys to select the digit place to be modified. If the focus cursor is in the leftmost data place of the parameter, press  to left pad the parameter with zeros.
- When inputting parameters using the numeric keyboard,  is used to delete the character while  is used to cancel the input and close the input field.

## 4.7.2 To Set Parameters with the Touch Screen

For this instrument, you can use the touch screen function to set all of its parameters. Click or tap the parameter input field and a virtual keypad will be displayed. You can use the pop-up keypad to complete your parameter setting. The method of using the virtual keypad is as follows.

### Input a String

When naming a file or folder, you need to use the string keypad to input a string.

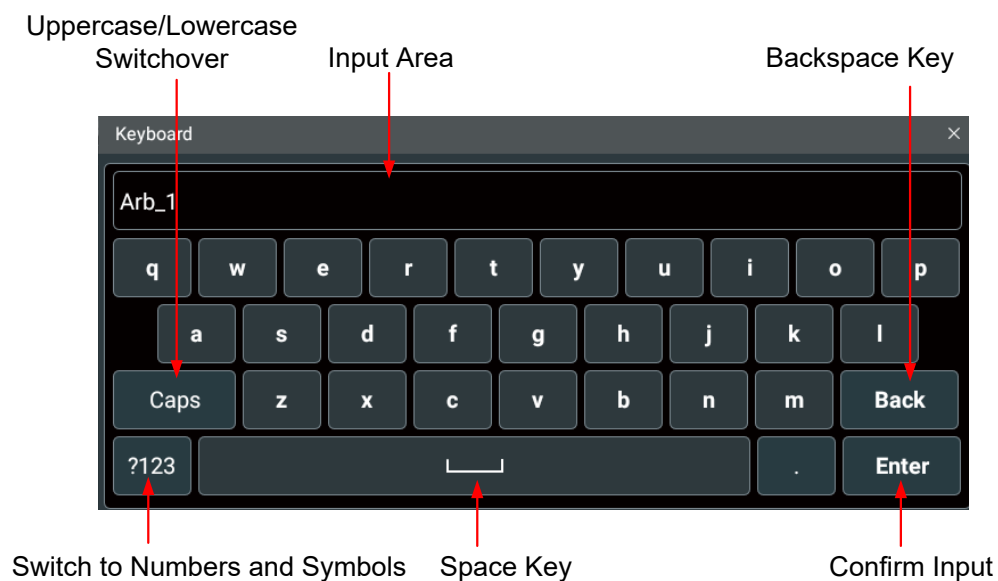

**Figure 4.20 String Keypad**

#### 1. Clear the name input area

If there is no character in the "Input Area", please go to the next step. If there are characters in the "Input Area", click or tap the "Back" key to delete all the characters from the "Input Area" in order.

#### 2. Input the upper-case letter

If you want to input an upper-case letter, first use the "Caps" key to switch between the upper-case and lower-case modes. If the "Caps" key is selected, input the upper-case letter with the virtual keypad. If not, first click or tap the Caps key to ensure it is selected, then input the upper-case letter. All the input letters will be displayed in the "Input Area".

#### 3. Input the lower-case letter

Refer to the operation specified in the previous step. If the Caps key is not selected, directly input the lower-case letter.

#### 4. Input numbers or symbols

If the letter keypad is displayed, you need to click or tap the numeric switchover key to switch to the numeric keypad, and input numbers or symbols with the numeric keypad. All the input letters will be displayed in the "Input Area".

#### 5. Delete or modify the unwanted characters that have been input

During the character input process, you can delete or modify the unwanted character if necessary. To delete the characters that have been input, move the cursor to the unwanted character and then click or tap the "Back" key in the virtual keypad. If you want to modify the characters that have been input, delete the unwanted characters first and then input the new characters.

#### 6. Confirm the input

After completing the input operation, click or tap "Enter".

### Input a Value

When setting or modifying a function parameter, you can input an appropriate value with the numeric keypad.

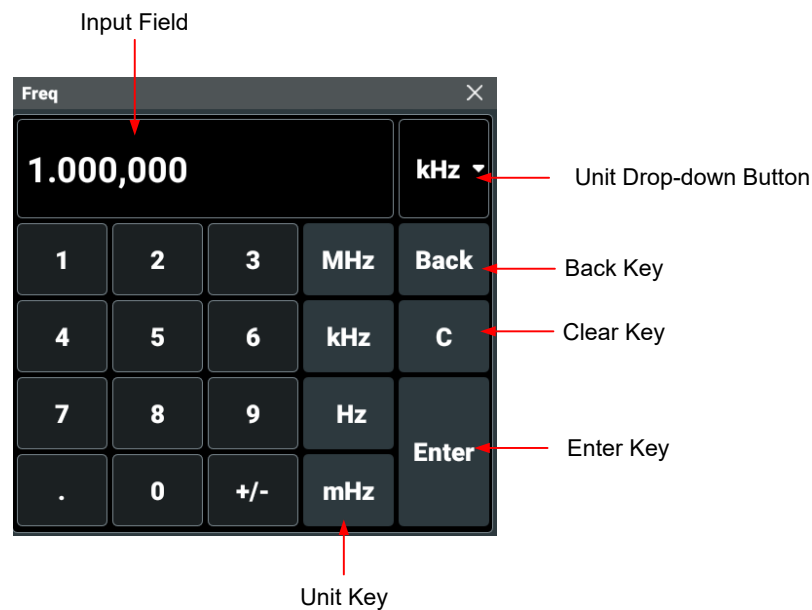

**Figure 4.21 Numeric Keypad**

Use the numeric keys in the numeric keypad to input a value. Then select the desired unit, and the numeric keypad is turned off automatically. This indicates that you have completed the parameter setting. The unit drop-down menu includes all available units. You can also click or tap the unit drop-down button to select the desired unit when multiple units are available. Then click or tap "Enter" to confirm input and close the numeric keypad.

## 4.8 To Replace the Fuse

If you need to replace the fuse, please use the proper fuse (AC 250 V, T5 A; 5.2 mm×20 mm) and follow the steps shown below (see [Figure 4.22](#)).

1. Power off the instrument and remove the power cord.
2. Insert a small straight screwdriver into the slot at the power socket and pry out the fuse holder gently.
3. Remove the fuse.
4. Insert the proper fuse into the fuse holder.
5. Re-insert the fuse holder into the power socket.

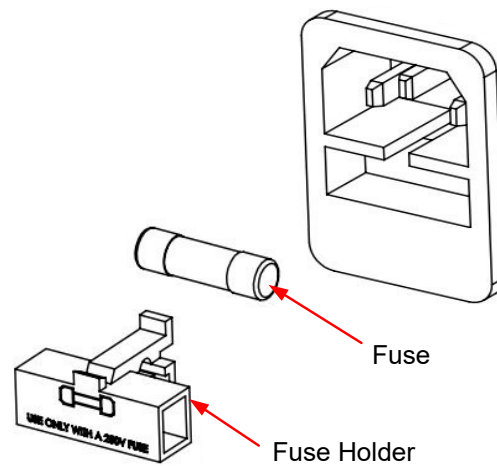

Figure 4.22 Replace the Fuse



### WARNING

To avoid electric shock, please make sure that the instrument is powered off and disconnected from the power before replacing the fuse. Also, please make sure the fuse is consistent with the required fuse rating.

## 4.9 To Use the Security Lock

If necessary, you can lock the instrument to a fixed location by using a standard laptop security lock (please purchase it by yourself), as shown in the figure below.

The method is as follows: align the lock with the lock hole and plug it into the lock hole vertically, turn the key clockwise to lock the instrument, and then pull the key out.



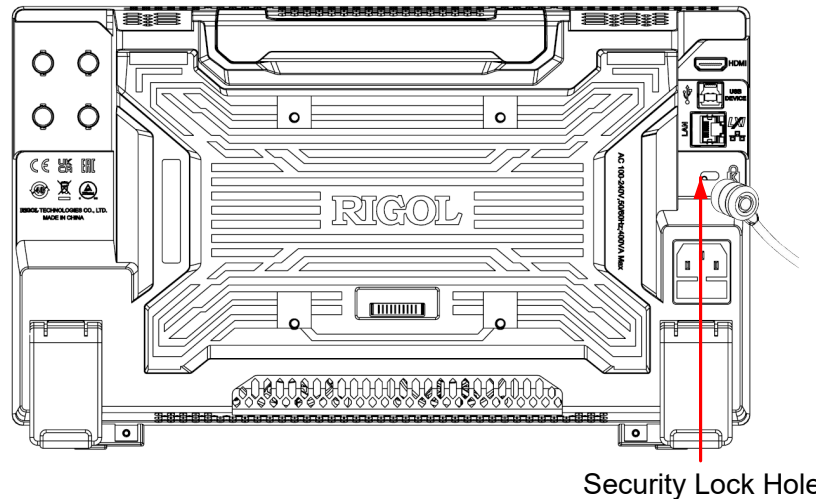

Figure 4.23 Use the Security Lock



#### CAUTION

Please do not insert other objects into the security lock hole to avoid damaging the instrument.

## 4.10 To Use the Built-in Help System

The built-in help file provides information about the functions and menu

introductions of the instrument. Click or tap  > **Help** to enter the help system.

In the help system, you can get its help information by clicking on or tapping the link for the specified chapter.

## 4.11 To View the Option Information and Install the Option

DG5000 Pro provides performance and function upgrade options to fulfill your requirements. If you need any of these options, please order them according to the Order No. available in *Appendix A: Options and Accessories*, and then install the options by referring to this section. Besides, you can also view all options of the instrument or activate the newly purchased option.

### View Options

Click or tap the navigation icon  > **Utility** to enter the Utility menu. Click or tap **Options** to view the option installation information.

## Install Options

The option license is a string of fixed characters. The option file should be in specific format, with the file extension ".lic". After you purchase an option, you will obtain a key (used for obtaining desired the option license code). Then, you can install the option according to the following steps.

### 1. Obtain an Option License

- a. Log in to the RIGOL official website (<http://www.rigol.com>), click **SERVICE CENTRE > License Activation** to enter the software license registration;
- b. In the software license registration interface, input the correct key, serial number (click or tap  > **Utility > About** to obtain the serial number of the instrument), and verification code. Then click **Generate** to obtain the option license. If you need to use the file, please download it to the USB storage device.

### 2. Install the Option

You can install the option in the following ways:

- Open the file (\*.lic) to obtain the license. Use the :SYSTem:LICense:INSTall <License> command to install the option.
- Save the license file to the USB storage device and connect the USB correctly to the instrument (you can also save the file to the C disk). Then use the SYSTem:LICense:INSTall:UDISK <path> command to install the option.
- Save the license file to the USB storage device, connect the USB correctly to the instrument (you can also save the file to the C disk). Then click or tap **Store/ Recall** to open the "Store" menu. Select the license file and then click or tap **Option** to install the option.

After installation, a prompt message "Option activated successfully" is displayed.

#### TIP

- For SCPI commands, refer to DG5000 Pro Programming Guide.
- During the installation process, you are not allowed to power off the instrument.
- You are not allowed to modify the license filename.



## 5 Continuous

Click or tap the "Output Mode" drop-down button to select "Cont" and configure the channel to output continuous waveform. The Continuous setting interface is as shown in the figure below. You can click or tap one of the tabs at the bottom to access the Continuous Setting Interface or Channel Setup Interface. For Channel Setup Interface, please refer to *Channel Setup*. This chapter only describes the Continuous settings.

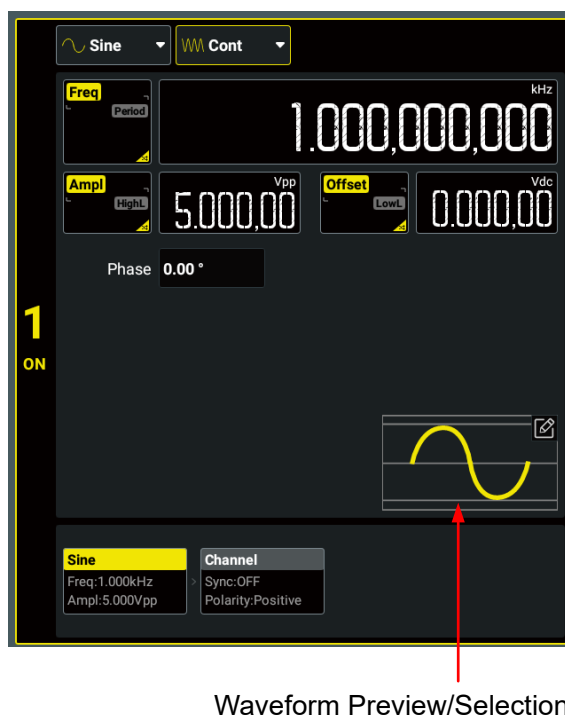

Waveform Preview/Selection

**Figure 5.1 Continuous Setting Interface**

The following tables show the ranges of the continuous waveform (except DC and noise) frequency and amplitude respectively.

**Table 5.1 Range of Continuous Waveform Frequency**

| Waveform | DG5252 Pro/<br>DG5254 Pro/<br>DG5258 Pro             | DG5352 Pro/<br>DG5354 Pro/<br>DG5358 Pro             | DG5502 Pro/<br>DG5504 Pro/<br>DG5508 Pro             |
|----------|------------------------------------------------------|------------------------------------------------------|------------------------------------------------------|
| Sine     | 1 $\mu$ Hz to 250 MHz                                | 1 $\mu$ Hz to 350 MHz                                | 1 $\mu$ Hz to 500 MHz                                |
| Square   | Fast transition<br>enabled: 1 $\mu$ Hz to<br>170 MHz | Fast transition<br>enabled: 1 $\mu$ Hz to<br>170 MHz | Fast transition<br>enabled: 1 $\mu$ Hz to<br>170 MHz |

| Waveform | DG5252 Pro/<br>DG5254 Pro/<br>DG5258 Pro   | DG5352 Pro/<br>DG5354 Pro/<br>DG5358 Pro   | DG5502 Pro/<br>DG5504 Pro/<br>DG5508 Pro   |
|----------|--------------------------------------------|--------------------------------------------|--------------------------------------------|
|          | Fast transition disabled: 1 μHz to 120 MHz | Fast transition disabled: 1 μHz to 120 MHz | Fast transition disabled: 1 μHz to 120 MHz |
| Ramp     | 1 μHz to 5 MHz                             | 1 μHz to 5 MHz                             | 1 μHz to 5 MHz                             |
| Pulse    | 1 μHz to 120 MHz                           | 1 μHz to 120 MHz                           | 1 μHz to 120 MHz                           |
| Arb      | 1 μHz to 100 MHz                           | 1 μHz to 100 MHz                           | 1 μHz to 100 MHz                           |
| Harmonic | 1 mHz to 125 MHz                           | 1 mHz to 175 MHz                           | 1 mHz to 250 MHz                           |

**Table 5.2 Range of Amplitude**

| Frequency          | HighZ            |                                   | Load (50 Ω)      |                                   |
|--------------------|------------------|-----------------------------------|------------------|-----------------------------------|
|                    | Amplitude Range  | Maximum Peak Value <sup>[1]</sup> | Amplitude Range  | Maximum Peak Value <sup>[1]</sup> |
| [1 μHz, 100 MHz]   | 2 mVpp to 20 Vpp | 10 V                              | 1 mVpp to 10 Vpp | 5 V                               |
| (100 MHz, 250 MHz] | 2 mVpp to 10 Vpp | 5 V                               | 1 mVpp to 5 Vpp  | 2.5 V                             |
| (250 MHz, 350 MHz] | 2 mVpp to 4 Vpp  | 2 V                               | 1 mVpp to 2 Vpp  | 1 V                               |
| (350 MHz, 500 MHz] | 2 mVpp to 2 Vpp  | 1 V                               | 1 mVpp to 1 Vpp  | 500 mV                            |

**NOTE**

[1]: The maximum peak value is the maximum value of the waveform high level that can be set. The waveform amplitude and offset are limited by this value:  $\text{Amplitude}/2 + |\text{Offset}| \leq \text{Maximum Peak Value}$ .



## 5.1 To Output Sine Wave

In the Continuous mode, you can configure the instrument to output sine in the following ways.

- In the Continuous Setting Interface (*Figure 5.1*), click or tap the "Wave Type" drop-down button to select "Sine".

- In the Continuous Setting Interface (*Figure 5.1*), click or tap the "Waveform Preview/Selection" area and then click or tap **Built In Wforms** > **Sine**.
- Press the front-panel  key.

In the setting interface for Sine wave, you can set the following parameters to create different sine waves as desired.

### Frequency/Period

Click or tap the **Freq/Period** button or press the front-panel  key to set the parameter to "Freq". "Freq" is now highlighted. Click or tap its input field and use the pop-up numeric keypad to set the frequency for sine wave. By default, the frequency for sine wave is 1 kHz, and the resolution is 1  $\mu$ Hz. For available ranges of the sine frequency of different models, please refer to *Table 5.1 Range of Continuous Waveform Frequency*. You can click or tap the **Freq/Period** button again or press the



key to toggle the parameter to "Period".  $\text{Period} = 1/\text{Frequency}$ .

### Amplitude/High Level

Click or tap the **Ampl/HighL** button or press the front-panel  key to set the parameter to "Ampl". "Ampl" is now highlighted. Click or tap its input field and use the pop-up numeric keypad to set the amplitude for sine wave. Available units for amplitude include Vpp, Vrms, and dBm (not available in HighZ). The amplitude for sine wave is 5 Vpp by default. The range of amplitude is limited by "Impedance", "Frequency/Period", and "Offset" settings. For details, refer to *Table 5.2 Range of Amplitude*.

Click or tap the **Ampl/HighL** button again or press the  key to toggle the parameter to "HighL".  $\text{High Level} = \text{Offset} + \text{Amplitude}/2$ . The high level range is related to the low level setting value. That is, high level minus low level cannot exceed the current range of amplitude (*Table 5.2 Range of Amplitude*).

### NOTE

#### 1. How to convert the amplitude in Vpp to the corresponding value in Vrms?

Vpp is the unit for signal peak-peak value and Vrms is the unit for signal effective value. The default unit is Vpp. When setting the amplitude with the pop-up numeric keypad, you can click or tap the unit drop-down button to select the desired unit and then click or tap "Enter" to confirm the current amplitude unit setting. You cannot set the amplitude in dBm or Vrms for Arb and Harmonic.

The relationship between Vpp and Vrms varies for different waveforms. Take sine wave as an example. The relationship between the two units is as shown in the figure below.



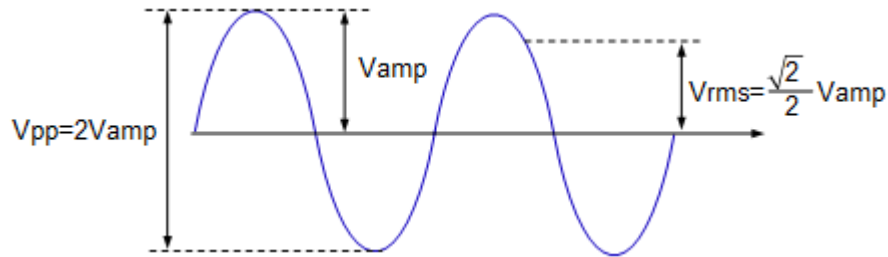

According to the figure above, the conversion relationship between Sine Vpp and Vrms fulfills the following equation:

$$V_{pp}=2\sqrt{2} V_{rms}$$

## 2. How to set the waveform amplitude in the unit of dBm?

- Set the impedance to "Load" (refer to *Output Impedance*).
- When setting the amplitude, click or tap the unit drop-down button to select "dBm" in the pop-up numeric keypad.
- Input the desired value and then click or tap "Enter" to set the waveform amplitude in dBm.

dBm is the unit for signal power absolute value. The relationship between dBm and Vrms fulfills the following equation:

$$dBm=10\lg\left(\frac{V_{rms}^2}{R}\times\frac{1}{0.001W}\right)$$

W is the unit of the signal power. R represents the channel output impedance value which must be a certain value. Therefore, dBm is not available when the output impedance is set to "HighZ".

## Offset/Low Level

Click or tap the **Offset/LowL** button or press the front-panel  key to set the parameter to "Offset". "Offset" is now highlighted. Click or tap its input field and use the pop-up numeric keypad to set the offset for sine wave. The range of offset is limited by the "Impedance", "Frequency/Period", and "Amplitude/High Level" settings. The default value is 0 Vdc.

Click or tap the **Offset/LowL** button again or press the  key to toggle the parameter to "LowL". Low Level = Offset - Amplitude/2. The low level range is related to the high level setting value. That is, high level minus low level cannot exceed the current range of amplitude (*Table 5.2 Range of Amplitude*).

## TIP

The "Ampl" and "Offset" buttons appear at the same time, and so are "HighL" and "LowL" buttons. For example, selecting "Offset" automatically toggles the "Ampl/HighL" parameter to "Ampl".



### Starting Phase

Click or tap the **Phase** input field to set the starting phase, which ranges from -360° to 360°. The default phase is 0°, and the resolution is 0.01°.

## 5.2 To Output Square Wave

In the Continuous mode, you can configure the instrument to output square in the following ways.

- In the Continuous Setting Interface (*Figure 5.1*), click or tap the "Basic Wave Type" drop-down button to select "Square".
- In the Continuous Setting Interface (*Figure 5.1*), click or tap the "Waveform Preview/Selection" area and then click or tap **Built In Wforms** > **Square**.
- Press the front-panel  key.

In the setting interface for Square wave, you can set the following parameters to create different square waves as desired.

### Frequency/Period

Click or tap the **Freq/Period** button or press the front-panel  key to set the parameter to "Freq". "Freq" is now highlighted. Click or tap its input field and use the pop-up numeric keypad to set the frequency for square waveform. By default, the frequency for square is 1 kHz and the resolution is 1 μHz. For available ranges of the square frequency of different models, please refer to *Table 5.1 Range of Continuous Waveform Frequency*. You can click or tap the **Freq/Period** button again or press the

 key to toggle the parameter to "Period".  $\text{Period} = 1/\text{Frequency}$ .

### Amplitude/High Level

Click or tap the **Ampl/HighL** button or press the front-panel  key to set the parameter to "Ampl". "Ampl" is now highlighted. Click or tap its input field and use the pop-up numeric keypad to set the amplitude for square waveform. Available units for amplitude include Vpp, Vrms, and dBm (not available in HighZ). For how to set the amplitude in Vrms or dBm, please refer to *To Output Sine Wave*. The amplitude for square wave is 5 Vpp by default. The ranges of amplitude is limited by "Impedance", "Frequency/Period", and "Offset" settings. For details, refer to *Table 5.2 Range of Amplitude*.

Click or tap the **Ampl/HighL** button again or press the  key to toggle the parameter to "HighL".  $\text{High Level} = \text{Offset} + \text{Amplitude}/2$ . The high level range is related to the low level setting value. That is, high level minus low level cannot exceed the current range of amplitude (*Table 5.2 Range of Amplitude*).

## Offset/Low Level

Click or tap the **Offset/LowL** button or press the front-panel  key to set the parameter to "Offset". "Offset" is now highlighted. Click or tap its input field and use the pop-up numeric keypad to set the offset for square waveform. The range of offset is limited by the "Impedance", "Frequency/Period", and "Amplitude/High Level" settings. The default value is 0 Vdc.

Click or tap the **Offset/LowL** button again or press the  key to toggle the parameter to "LowL". Low Level = Offset - Amplitude/2. The low level range is related to the high level setting value. That is, high level minus low level cannot exceed the current range of amplitude (*Table 5.2 Range of Amplitude*).

### TIP

The "Ampl" and "Offset" buttons appear at the same time, and so are "HighL" and "LowL" buttons. For example, selecting "Offset" automatically toggles the "Ampl/HighL" parameter to "Ampl".

## Starting Phase

Click or tap the **Phase** input field to set the starting phase, which ranges from -360° to 360°. The default phase is 0°, and the resolution is 0.01°.

## Duty Cycle

Duty cycle represents the amount of time per period that the square wave is at a high level, as shown in the figure below. The "Duty Cycle" parameter setting only appears when "Square" or "Pulse" is selected.

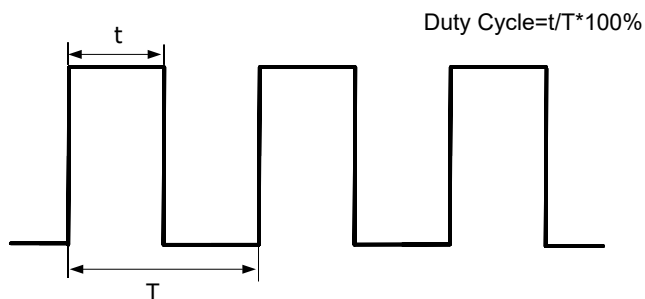

Click or tap the **Duty Cycle** input field to set the duty cycle. The available range is from 0.01% to 99.99% (depending on the Frequency/Period setting). By default, it is 50%, and the resolution is 0.01%.

### TIP

When the fast transition function is disabled, the actual available duty cycle is limited by the period:  $(4.2 \text{ ns/Square Period}) * 100\% \leq \text{Square Duty Cycle} \leq (1 - 4.2 \text{ ns/Square Period}) * 100\%$ .



### Fast Transition/Transition Time

In the Continuous output mode, the method for generating the edges of the square wave can be specified. Click or tap the **Fast Tran** on/off switch to enable or disable the fast transition function for square wave. When the function is enabled, you can set the fast transition time for square wave. The range is from 800 ps to 1 ns and the precision is 100 ps.

| Fast Transition On/Off | Square Frequency      | Square Transition Time   | Square Duty Cycle         |
|------------------------|-----------------------|--------------------------|---------------------------|
| On                     | 1 $\mu$ Hz to 170 MHz | Settable, 800 ps to 1 ns | Fixed to 50%              |
| Off                    | 1 $\mu$ Hz to 120 MHz | Not settable, 1.4 ns     | Settable, 0.01% to 99.99% |



#### TIP

- The fast transition on/off and transition time can be set for square wave only in Continuous mode. The fast transition is automatically disabled when the output mode is set to Burst, Sweep, or Modulation for the specified channel.
- When the fast transition function is disabled, the maximum output frequency of square wave is limited to 120 MHz.

## 5.3 To Output Ramp Wave

In the Continuous mode, you can configure the instrument to output ramp in the following ways.

- In the Continuous Setting Interface (*Figure 5.1*), click or tap the "Wave Type" drop-down button to select "Ramp".
- In the Continuous Setting Interface (*Figure 5.1*), click or tap the "Waveform Preview/Selection" area and then click or tap **Built In Wforms > Ramp**.
- Press the front-panel  key.

In the setting interface for Ramp wave, you can set the following parameters to create different ramp waves as desired.

#### Frequency/Period

Click or tap the **Freq/Period** button or press the front-panel  key to set the parameter to "Freq". "Freq" is now highlighted. Click or tap its input field and use the pop-up numeric keypad to set the frequency for ramp waveform. By default, the frequency for ramp wave is 1 kHz and the resolution is 1  $\mu$ Hz. For available ranges of the ramp frequency of different models, please refer to *Table 5.1 Range of Continuous*

**Waveform Frequency**. You can click or tap the **Freq/Period** button again or press the



key to toggle the parameter to "Period".  $\text{Period} = 1/\text{Frequency}$ .

### Amplitude/High Level

Click or tap the **Ampl/HighL** button or press the front-panel  key to set the parameter to "Ampl". "Ampl" is now highlighted. Click or tap its input field and use the pop-up numeric keypad to set the amplitude for ramp wave. Available units for amplitude include Vpp, Vrms, and dBm (not available in HighZ). For how to set the amplitude in Vrms or dBm, please refer to *To Output Sine Wave*. The amplitude for Ramp wave is 5 Vpp by default. The ranges of amplitude is limited by the "Impedance", "Frequency/Period", and "Offset" settings. For details, refer to *Table 5.2 Range of Amplitude*.

Click or tap the **Ampl/HighL** button again or press the  key to toggle the parameter to "HighL".  $\text{High Level} = \text{Offset} + \text{Amplitude}/2$ . The high level range is related to the low level setting value. That is, high level minus low level cannot exceed the current range of amplitude (*Table 5.2 Range of Amplitude*).

### Offset/Low Level

Click or tap the **Offset/LowL** button or press the front-panel  key to set the parameter to "Offset". "Offset" is now highlighted. Click or tap its input field and use the pop-up numeric keypad to set the offset for ramp waveform. The range of offset is limited by the "Impedance", "Frequency/Period", and "Amplitude/High Level" settings. The default value is 0 Vdc.

Click or tap the **Offset/LowL** button again or press the  key to toggle the parameter to "LowL".  $\text{Low Level} = \text{Offset} - \text{Amplitude}/2$ . The low level range is related to the high level setting value. That is, high level minus low level cannot exceed the current range of amplitude (*Table 5.2 Range of Amplitude*).

### TIP

The "Ampl" and "Offset" buttons appear at the same time, and so are "HighL" and "LowL" buttons. For example, selecting "Offset" automatically toggles the "Ampl/HighL" parameter to "Ampl".

### Starting Phase

Click or tap the **Phase** input field to set the starting phase, which ranges from  $-360^\circ$  to  $360^\circ$ . The default phase is  $0^\circ$ , and the resolution is  $0.01^\circ$ .

### Symmetry

Symmetry is defined as the percentage of the amount of time Ramp wave is rising in the period, as shown in the figure below. It only appears when "Ramp" is selected.



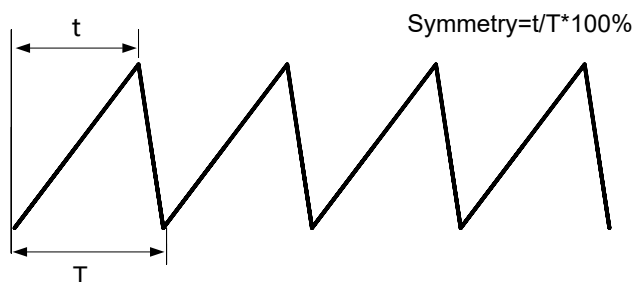

Click or tap the **Symmetry** input field to set the symmetry, which ranges from 0.1% to 99.9%. The default value is 50%, and the resolution is 0.1%. In actual use, the symmetry is limited by the period, that is,  $20 \text{ ns} \leq \text{Symmetry} * \text{Period} \leq \text{Period} - 20 \text{ ns}$ .

## 5.4 To Output Pulse

In the Continuous mode, you can configure the instrument to output pulse in the following ways.

- In the Continuous Setting Interface (*Figure 5.1*), click or tap the "Basic Wave Type" drop-down button to select "Pulse".
- In the Continuous Setting Interface (*Figure 5.1*), click or tap the "Waveform Preview/Selection" area and then click or tap **Built In Wforms** > **Pulse**.
- Press the front-panel  key.

In addition to basic parameters (e.g. Frequency, Amplitude, Offset, Starting Phase, High Level, Low Level) mentioned before, you also need to set the "Pulse Width/Duty Cycle", "Rising Edge", and "Falling Edge".

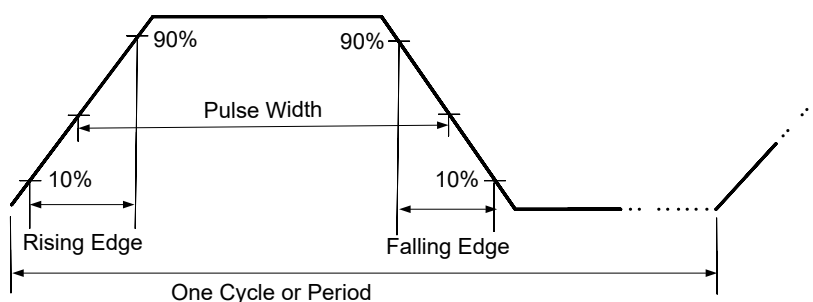



### Frequency/Period

Click or tap the **Freq/Period** button or press the front-panel  key to set the parameter to "Freq". "Freq" is now highlighted. Click or tap its input field and use the pop-up numeric keypad to set the frequency for pulse waveform. By default, the frequency for Pulse is 1 kHz and the resolution is 1  $\mu\text{Hz}$ . For available ranges of the pulse frequency of different models, please refer to *Table 5.1 Range of Continuous Waveform Frequency*. You can click or tap the **Freq/Period** button again or press the

 key to toggle the parameter to "Period".  $\text{Period} = 1/\text{Frequency}$ .

## Amplitude/High Level

Click or tap the **Ampl/HighL** button or press the front-panel  key to set the parameter to "Ampl". "Ampl" is now highlighted. Click or tap its input field and use the pop-up numeric keypad to set the amplitude for pulse waveform. Available units for amplitude include Vpp, Vrms, and dBm (not available in HighZ). For how to set the amplitude in Vrms or dBm, please refer to *To Output Sine Wave*. The amplitude for pulse wave is 5 Vpp by default. The range of amplitude is limited by the "Impedance", "Frequency/Period", and "Offset" settings. For details, refer to *Table 5.2 Range of Amplitude*.

Click or tap the **Ampl/HighL** button again or press the  key to toggle the parameter to "HighL". High Level = Offset + Amplitude/2. The high level range is related to the low level setting value. That is, high level minus low level cannot exceed the current range of amplitude (*Table 5.2 Range of Amplitude*).

## Offset/Low Level

Click or tap the **Offset/LowL** button or press the front-panel  key to set the parameter to "Offset". "Offset" is now highlighted. Click or tap its input field and use the pop-up numeric keypad to set the offset for pulse waveform. The range of offset is limited by the "Impedance", "Frequency/Period", and "Amplitude/High Level" settings. The default value is 0 Vdc.

Click or tap the **Offset/LowL** button again or press the  key to toggle the parameter to "LowL". Low Level = Offset - Amplitude/2. The low level range is related to the high level setting value. That is, high level minus low level cannot exceed the current range of amplitude (*Table 5.2 Range of Amplitude*).

### TIP

The "Ampl" and "Offset" buttons appear at the same time, and so are "HighL" and "LowL" buttons. For example, selecting "Offset" automatically toggles the "Ampl/HighL" parameter to "Ampl".

## Starting Phase

Click or tap the **Phase** input field to set the starting phase, which ranges from -360° to 360°. The default phase is 0°, and the resolution is 0.01°.

## Pulse Width/Duty Cycle

Pulse width is the time from the 50% threshold of a pulse's rising edge to the 50% threshold of the next falling edge, as shown in the figure above. Pulse duty cycle is defined as the percentage of the pulse width to the pulse period. Changing one of them automatically modifies the other.

Click or tap the **Width/Duty** button to set the parameter to "Width". "Width" is now highlighted. Click or tap its input field and use the pop-up numeric keypad to set the



pulse width. The available range is from 4.2 ns to 999.9 ks. The default value is 500  $\mu$ s and the resolution is 0.1 ns.

Click or tap the button to toggle the parameter to "Duty". Duty Cycle = Pulse Width/Period. The available range is from 0.01% to 99.99%. The default value is 50% and the resolution is 0.01%.



#### TIP

- The pulse width must conform to the following restrictions determined by the period and the minimum pulse width ( $W_{min}$ : 4.2 ns): Minimum Pulse Width  $\leq$  Pulse Width  $\leq$  (Period - Minimum Pulse Width).
- The pulse duty cycle must conform to the following restrictions determined by the minimum pulse width and pulse period: (Minimum Pulse Width/Period)\*100%  $\leq$  Pulse Duty Cycle  $\leq$  (1 - Minimum Pulse Width/Period)\*100%.

#### Leading/Trailing Edge

The leading (rising) edge time is the time it takes for the pulse level to go from 10% to 90%; trailing (falling) edge time is the time it takes for the pulse level to go from 90% to 10%.

Click or tap the **Leading/Trailing** input field and use the pop-up numeric keypad to set the leading edge time/trailing edge time. The leading/trailing edge time ranges from 1.4 ns to 1 s (limited by the pulse width). The default value is 1.4 ns and the resolution is 0.1 ns.

## 5.5 To Output Noise

In the Continuous mode, you can configure the instrument to output noise in the following ways.

- In the Continuous Setting Interface (*Figure 5.1*), click or tap the "Basic Wave Type" drop-down button to select "Noise".
- In the Continuous Setting Interface (*Figure 5.1*), click or tap the "Waveform Preview/Selection" area and then click or tap **Built In Wforms** > **Noise**.
- Press the front-panel  key.

In the setting interface for Noise, you can set the following parameters to create different noises as desired.

#### Amplitude/High Level

Click or tap the **Ampl/HighL** button or press the front-panel  key to set the parameter to "Ampl". "Ampl" is now highlighted. Click or tap its input field and use the pop-up numeric keypad to set the amplitude for noise. Available units for amplitude include Vpp, Vrms, and dBm (not available in HighZ). The amplitude for

noise is 2 Vpp by default. The available range is related to the "Impedance" setting and is limited by "Offset".

- HighZ: 2 mVpp to 2 Vpp, and  $\text{Amplitude}/2 + |\text{Offset}| \leq 1 \text{ Vpp}$ .
- Load (50 Ω): 1 mVpp to 1 Vpp, and  $\text{Amplitude}/2 + |\text{Offset}| \leq 500 \text{ mVpp}$ .

Click or tap the **Ampl/HighL** button again or press the  key to toggle the parameter to "HighL". High Level = Offset + Amplitude/2. The high level range is related to the low level setting value. That is, high level minus low level cannot exceed the current range of amplitude.

### Offset/Low Level

Click or tap the **Offset/LowL** button or press the front-panel  key to set the parameter to "Offset". "Offset" is now highlighted. Click or tap its input field and use the pop-up numeric keypad to set the offset for noise. The range of offset is limited by the "Impedance" and "Amplitude/High Level" setting. The default offset is 0 Vdc.

Click or tap the **Offset/LowL** button again or press the  key to toggle the parameter to "LowL". Low Level = Offset - Amplitude/2. The low level range is related to the high level setting value. That is, high level minus low level cannot exceed the current range of amplitude.

### TIP

The "Ampl" and "Offset" buttons appear at the same time, and so are "HighL" and "LowL" buttons. For example, selecting "Offset" automatically toggles the "Ampl/HighL" parameter to "Ampl".



## 5.6 To Output DC

In the Continuous mode, you can configure the instrument to output DC waveform in the following ways.

- In the Continuous Setting Interface (*Figure 5.1*), click or tap the "Basic Wave Type" drop-down button to select "DC".
- In the Continuous Setting Interface (*Figure 5.1*), click or tap the "Waveform Preview/Selection" area and then click or tap **Built In Wforms > DC**.

After entering the DC setting interface, you can set the offset for the DC waveform. The range of DC offset is related to the "Impedance" setting.

- HighZ: -10 Vdc to +10 Vdc.
- Load (50 Ω): -5 Vdc to +5 Vdc.

## 5.7 To Output Arbitrary Waveforms

DG5000 Pro supports Arb output in both Continuous mode and Advanced mode. In the Continuous mode, DG5000 Pro outputs waveforms by the traditional DDS method. The output frequency ranges from 1  $\mu$ Hz to 100 MHz and the sample rate is fixed to 2.5 GSa/s. This section introduces how to output arbitrary waveforms in the Continuous mode.



### TIP

If you want to change the sample rate and output the arbitrary waveforms point by point, switch to the Advanced mode (*Advanced Mode*).

### Select the Data Source

- **Stored Waveforms**

In the Continuous Setting Interface (*Figure 5.1*), click or tap the "Waveform Preview/Selection" area and then click or tap **Stored Wforms** in the displayed menu to open the storage menu. Select the Arb file (\*.arb/\*.csv/\*.txt) that you want to load from the internal memory (C:) or the external storage device (D:) and then click or tap **Load**. After loading, the data in the current volatile memory space will change. You can use the instrument's built-in Arb editor to edit and save the Arb waveform (only \*.arb). You can also edit the Arb waveform through the PC software and download it into the instrument. It is recommended to use the PC software Ultra Station provided by RIGOL. The installation package and help manual of the software can be obtained from RIGOL official website.



### TIP

- The non-advanced output mode only supports arbitrary waveforms with the length of 16,384 pts.
- DG5000 Pro does not support loading Arb files with file headers. It is recommended to use Ultra Station 00.02.01.00.01 or later to generate Arb waveforms and untick the "Save File With Header" box when saving the file.



### NOTE

DG5000 Pro supports arb files in \*.arb, \*.csv, and \*.txt formats.

- \*.arb files are data files that store binary values.
- \*.csv files are voltage data stored in plain text, floating type.
- \*.txt files are plaintext voltage data (floating) or normalized wave point data (-32768 to +32767) files separated by separators (enter, comma, or semicolon). Only one separator and data format can be used in the same file. When loading the \*.txt file, select the correct data separator and file data format in the pop-up sub-menu.

- **Built-in Waveforms**

In the Continuous Setting Interface (*Figure 5.1*), click or tap the "Waveform Preview/Selection" area and then click or tap **Built In Wforms** in the displayed menu to open the built-in waveform selection menu. You click or tap **Common**, **Engine**, **Seg Mod**, **Bioelect**, **Medical**, **Standard**, **Maths**, **Trigonome**, **Anti Trigonome**, and **Window Function** to select your desired Arb waveform. The selected waveform type is indicated in **Shape** in the Arb setting interface.

**Table 5.4 Built-in Waveforms**

| Name               | Descriptions                                           |
|--------------------|--------------------------------------------------------|
| <b>Common</b>      |                                                        |
| Abs sine           | Sine absolute value                                    |
| Abs sine half      | Half-sine absolute value                               |
| Amp alt            | Gain oscillation curve                                 |
| Att alt            | Attenuation oscillation curve                          |
| Gauss pulse        | Gaussian pulse                                         |
| Neg ramp           | Negative ramp                                          |
| N pulse            | Negative pulse                                         |
| P pulse            | Positive pulse                                         |
| Pos ramp           | Positive ramp                                          |
| Sin tra            | Sine-Tra waveform                                      |
| Sine ver           | Sine-Ver waveform                                      |
| Stair Dn           | Stair down                                             |
| Stair Ud           | Stair up/down                                          |
| Stair Up           | Stair up                                               |
| Trapezia           | Trapezia                                               |
| <b>Engineering</b> |                                                        |
| 2ndosr01           | 2nd order step response (attenuation constant: 0.1)    |
| 2ndosr02           | 2nd order step response (attenuation constant: 0.2)    |
| 2ndosr07           | 2nd order step response (attenuation constant: 0.7)    |
| 2ndoir01           | 2nd order impulse response (attenuation constant: 0.1) |
| 2ndoir02           | 2nd order impulse response (attenuation constant: 0.2) |
| 2ndoir07           | 2nd order impulse response (attenuation constant: 0.7) |
| Prbs9              | Pseudo-Random Binary Sequence of order 9               |
| Prbs11             | Pseudo-Random Binary Sequence of order 11              |
| Prbs15             | Pseudo-Random Binary Sequence of order 15              |
| Prbs16             | Pseudo-Random Binary Sequence of order 16              |



| Name            | Descriptions                              |
|-----------------|-------------------------------------------|
| Prbs20          | Pseudo-Random Binary Sequence of order 20 |
| Prbs21          | Pseudo-Random Binary Sequence of order 21 |
| Prbs23          | Pseudo-Random Binary Sequence of order 23 |
| Three Tone      | Three-tone signal                         |
| Four Tone       | Four-tone signal                          |
| Five Tone       | Five-tone signal                          |
| Six Tone        | Six-tone signal                           |
| Seven Tone      | Seven-tone signal                         |
| Eight Tone      | Eight-tone signal                         |
| Bandlimited     | Band-limited signal                       |
| Blaseiwave      | Time-velocity curve                       |
| Butterworth     | Butterworth filter                        |
| Chebyshev1      | Type I Chebyshev filter                   |
| Chebyshev2      | Type II Chebyshev filter                  |
| Combin          | Combination function                      |
| Cpulse          | C-Pulse signal                            |
| Cw Pulse        | CW pulse signal                           |
| Damped Osc      | Damped oscillation time-offset curve      |
| Distortion      | Distorted waveform                        |
| Dampedsine1     | Damped sine wave (1 Hz frequency)         |
| Dampedsine3     | Damped sine wave (3 Hz frequency)         |
| Dampedsine5     | Damped sine wave (5 Hz frequency)         |
| Dualtone        | Dual-tone signal                          |
| Gamma           | Gamma signal                              |
| Gatevibr        | Gate self-excited oscillating signal      |
| Lfm Pulse       | Linear frequency modulation pulse signal  |
| LowerSemicircle | Lower semicircle                          |
| Mcnoise         | Mechanical noise                          |
| Nimh Discharge  | Discharge curve of NiMH batteries         |
| Neg halvesine   | Negative half cycle of sine wave          |
| Pos Hwrsine     | Half wave rectifier of sine (positive)    |
| Neg Hwrsine     | Half wave rectifier of sine (negative)    |
| Pos Fwrsine     | Full wave rectifier of sine (positive)    |
| Neg Fwrsine     | Full wave rectifier of sine (negative)    |
| Pahcur          | DC brushless motor current waveform       |
| Quake           | Earthquake wave                           |
| Radar           | Radar signal                              |
| Ripple          | Power ripple                              |
| Roundhalf       | Roundhalf waveform                        |
| Stepresp        | Step response signal                      |

| Name                      | Descriptions                                                |
|---------------------------|-------------------------------------------------------------|
| Swing Osc                 | Swing oscillation kinetic energy-time curve                 |
| TV                        | TV signal                                                   |
| Voice                     | Voice signal                                                |
| <b>Segment Modulation</b> |                                                             |
| Three Am                  | Sine piecewise AM waveform                                  |
| Three Fm                  | Sine piecewise FM waveform                                  |
| Three Pfm                 | Pulse piecewise FM waveform                                 |
| Three Pm                  | Sine piecewise PM waveform                                  |
| Three Pwm                 | Pulse width piecewise FM waveform                           |
| <b>Bioelectricity</b>     |                                                             |
| Cardiac                   | Cardiac signal                                              |
| Ecg1                      | Electrocardiogram 1                                         |
| Ecg2                      | Electrocardiogram 2                                         |
| Ecg3                      | Electrocardiogram 3                                         |
| Ecg4                      | Electrocardiogram 4                                         |
| Ecg5                      | Electrocardiogram 5                                         |
| Ecg6                      | Electrocardiogram 6                                         |
| Ecg7                      | Electrocardiogram 7                                         |
| Ecg8                      | Electrocardiogram 8                                         |
| Ecg9                      | Electrocardiogram 9                                         |
| Ecg10                     | Electrocardiogram 10                                        |
| Ecg11                     | Electrocardiogram 11                                        |
| Ecg12                     | Electrocardiogram 12                                        |
| Ecg13                     | Electrocardiogram 13                                        |
| Ecg14                     | Electrocardiogram 14                                        |
| Ecg15                     | Electrocardiogram 15                                        |
| Eog                       | Electro-oculogram (EOG)                                     |
| Eeg                       | Electroencephalo-graph (EEG)                                |
| Emg                       | Electromyography (EMG)                                      |
| Pulsilogram               | Pulsilogram                                                 |
| Resspeed                  | Speed curve of the respiration                              |
| <b>Medical</b>            |                                                             |
| Lf Pulse                  | Low frequency pulse electrotherapy waveform                 |
| Tens1                     | Transcutaneous Electric Nerve Stimulation (TENS) waveform 1 |
| Tens2                     | Transcutaneous Electric Nerve Stimulation (TENS) waveform 2 |
| Tens3                     | Transcutaneous Electric Nerve Stimulation (TENS) waveform 3 |
| <b>Standard</b>           |                                                             |
| Ignition                  | Ignition waveform of the automotive motor                   |

| Name           | Descriptions                                            |
|----------------|---------------------------------------------------------|
| Iso16750 2 Sp  | Automotive starting profile with ringing                |
| Iso16750 2 Vr  | Automotive supply voltage profile for resetting         |
| Iso16750 2 Vit | Voltage discontinuous, variable interrupt time          |
| Iso16750 2 VRT | Voltage discontinuous, variable recovery time           |
| Iso16750 2 LD1 | Transients due to battery disconnect from the generator |
| Iso16750 2 LD2 | Transients due to battery disconnect from the generator |
| Iso7637 2 Tp1  | Automotive transients due to disconnects                |
| Iso7637 2 Tp2a | Automotive transients due to inductance in wiring       |
| Iso7637 2 Tp2b | Automotive transients due ignition switching off        |
| Iso7637 2 Tp3a | Automotive transients due to switching                  |
| Iso7637 2 Tp3b | Automotive transients due to switching                  |
| Iso7637 2 Tp4  | Automotive supply profile during starting               |
| Iso7637 2 Tp5a | Automotive transients due to battery disconnect         |
| Iso7637 2 Tp5b | Automotive transients due to battery disconnect         |
| Scr            | SCR firing profile                                      |
| Surge          | Surge signal                                            |
| <b>Maths</b>   |                                                         |
| Airy           | Airy function                                           |
| Airyai         | AiryAi                                                  |
| Airybi         | AiryBi                                                  |
| Besselj        | Bessell function                                        |
| Bessely        | Besselll function                                       |
| Cauchy         | Cauchy distribution function                            |
| Chebyshev3     | 3rd order Chebyshev polynomial                          |
| Chebyshev4     | 4th order Chebyshev polynomial                          |
| Chebyshev5     | 5th order Chebyshev polynomial                          |
| Chebyshev6     | 6th order Chebyshev polynomial                          |
| Chebyshev7     | 7th order Chebyshev polynomial                          |
| Chebyshev8     | 8th order Chebyshev polynomial                          |
| Chebyshev9     | 9th order Chebyshev polynomial                          |
| Chebyshev10    | 10th order Chebyshev polynomial                         |
| Clausen        | Clausen function                                        |
| Cubic          | Cubic function                                          |
| Dirichlet      | Dirichlet function                                      |
| Erf            | Error function                                          |
| Erfc           | Complementary error function                            |

| Name          | Descriptions                                              |
|---------------|-----------------------------------------------------------|
| Erfcinv       | Inverted complementary error function                     |
| Erfinv        | Inverted error function                                   |
| Expfall       | Exponential fall function                                 |
| Exprise       | Exponential rise function                                 |
| Gabor1        | Garbor function 1                                         |
| Gabor3        | Garbor function 3                                         |
| Gammalnv      | Inverse Gamma function                                    |
| Gauss         | Gaussian distribution (also known as normal distribution) |
| Gaussderiv    | Gaussian derivative                                       |
| Gausshermite1 | Gauss-Hermert function 1                                  |
| Gausshermite2 | Gauss-Hermert function 2                                  |
| Gausshermite3 | Gauss-Hermert function 3                                  |
| Gausshermite4 | Gauss-Hermert function 4                                  |
| Haversine     | HaverSine function                                        |
| Laguerre      | Laguerre polynomial                                       |
| Laguerre2     | 2nd order Laguerre polynomial                             |
| Laguerre3     | 3rd order Laguerre polynomial                             |
| Laguerre4     | 4th order Laguerre polynomial                             |
| Laguerre5     | 5th order Laguerre polynomial                             |
| Laguerre6     | 6th order Laguerre polynomial                             |
| Laguerre7     | 7th order Laguerre polynomial                             |
| Laguerre8     | 8th order Laguerre polynomial                             |
| Laguerre9     | 9th order Laguerre polynomial                             |
| Laplace       | Laplace distribution                                      |
| Legend        | Quintic Legendre polynomial                               |
| Legendre3     | 3rd order Legendre polynomial                             |
| Legendre4     | 4th order Legendre polynomial                             |
| Legendre5     | 5th order Legendre polynomial                             |
| Legendre6     | 6th order Legendre polynomial                             |
| Legendre7     | 7th order Legendre polynomial                             |
| Legendre8     | 8th order Legendre polynomial                             |
| Legendre9     | 9th order Legendre polynomial                             |
| Legendre10    | 10th order Legendre polynomial                            |
| Log           | Logarithmic function with the base of 10                  |
| Lognormal     | Logarithmic normal distribution                           |
| Lorentz       | Lorentz function                                          |
| Mathieu1      | 1st order Mathieu function                                |
| Mathieu3      | 3rd order Mathieu function                                |
| Mathieu5      | 5th order Mathieu function                                |
| Maxwell       | Maxwell distribution                                      |
| Modbesseli0   | Modified Bessel function                                  |

| Name                  | Descriptions                                 |
|-----------------------|----------------------------------------------|
| Rayleigh              | Rayleigh distribution                        |
| Sphbesselj1           | Spherical Bessel function of the first kind  |
| Sphbesselj2           | Spherical Bessel function of the second kind |
| Tick                  | Check-shaped function                        |
| Versiera              | Versiera                                     |
| Weibull               | Weibull distribution                         |
| Weierstrass           | Weierstrass function                         |
| X2                    | Square function                              |
| X3                    | Cubic function                               |
| <b>Trigonome</b>      |                                              |
| Cosh                  | Hyperbolic cosine                            |
| Coshc                 | Normalized Hyperbolic cosine                 |
| Cosint                | Cosine integral                              |
| Cot                   | Cotangent function                           |
| Coth Con              | Concave hyperbolic cotangent                 |
| Coth Pro              | Protuberant hyperbolic cotangent             |
| Csc Con               | Concave cosecant                             |
| Csc Pro               | Protuberant cosecant                         |
| Csch Con              | Concave hyperbolic cosecant                  |
| Csch Pro              | Protuberant hyperbolic cosecant              |
| Recip Con             | Concave reciprocal                           |
| Recip Pro             | Protuberant reciprocal                       |
| Sec Con               | Concave secant                               |
| Sec Pro               | Protuberant secant                           |
| Sech                  | Hyperbolic secant                            |
| Sinc                  | Sinc function                                |
| Sinh                  | Hyperbolic sine                              |
| Sinhc                 | Normalized Hyperbolic sine                   |
| Sinint                | Integral sine                                |
| Sqrt                  | Square root                                  |
| Tan                   | Tangent                                      |
| Tanh                  | Hyperbolic tangent                           |
| Tanhc                 | Normalized Hyperbolic tangent                |
| <b>Anti Trigonome</b> |                                              |
| Acos                  | Arc cosine                                   |
| Acosh                 | Arc hyperbolic cosine                        |
| Acot                  | Inverse cotangent function                   |
| Acot Con              | Concave arc cotangent                        |
| Acot Pro              | Protuberant arc cotangent                    |
| Acoth Con             | Concave arc hyperbolic cotangent             |
| Acoth Pro             | Protuberant arc hyperbolic cotangent         |

| Name                   | Descriptions                                          |
|------------------------|-------------------------------------------------------|
| Acsc Con               | Concave arc cosecant                                  |
| Acsc Pro               | Protuberant arc cosecant                              |
| Acsch Con              | Concave arc hyperbolic cosecant                       |
| Acsch Pro              | Protuberant arc hyperbolic cosecant                   |
| Archav                 | Inverse haversine function                            |
| Archcv                 | Inverse hacoversed sine function                      |
| Asec Con               | Concave arc secant                                    |
| Asec Pro               | Protuberant arc secant                                |
| Asech                  | Arc hyperbolic secant                                 |
| Asin                   | Arc Sinc                                              |
| Asinh                  | Arc hyperbolic sine                                   |
| Atan                   | Arc tangent                                           |
| Atanh                  | Arc hyperbolic tangent                                |
| <b>Window Function</b> |                                                       |
| Barlett                | Bartlett window                                       |
| Barthannwin            | Modified Bartlett window                              |
| Blackman               | Blackman window                                       |
| Blackman H             | BlackmanH window                                      |
| Bohmanwin              | Bohman window                                         |
| Boxcar                 | Rectangle window                                      |
| Chebwin                | Chebyshev window                                      |
| Flattopwin             | Flat-top window                                       |
| Hamming                | Hamming window                                        |
| Hanning                | Hanning window                                        |
| Kaiser                 | Kaiser window                                         |
| Nuttallwin             | Nuttall-defined minimum 4-term Blackman-Harris window |
| Parzenwin              | Parzen window                                         |
| Taylorwin              | Taylor window                                         |
| Triang                 | Triangle window (also Fejer window)                   |
| Tukeywin               | Tukey window                                          |

### Set the Waveform Parameters

After selecting the waveform, you can set the frequency/period, amplitude/high level, offset/low level, and phase. To set the waveform parameters and output, please refer to [To Output Sine Wave](#).

## 5.8 To Output Harmonic

DG5000 Pro can be used as a harmonic generator to output harmonics with the specified order, amplitude, and phase. It is usually used in the test of harmonic detector device or harmonic filter device. According to Fourier transform, time

domain waveform is the superposition of a series of sine waveforms as shown in the equation below:

$$f(t) = A_1 \sin(2\pi f_1 t + \varphi_1) + A_2 \sin(2\pi f_2 t + \varphi_2) + A_3 \sin(2\pi f_3 t + \varphi_3) + \dots$$

Generally, the component with  $f_1$  frequency is called the fundamental waveform, with  $f_1$  as the fundamental frequency,  $A_1$  as the fundamental amplitude, and  $\varphi_1$  as the fundamental phase. The frequencies of the other components (called harmonics) are all integral multiples of the fundamental frequency.

In the Continuous Setting Interface (*Figure 5.1*), click or tap the "Basic Wave Type" drop-down button to select "Harmonic". You can also click or tap the "Waveform Preview/Selection" area and then click or tap **Built In Wforms > Harmonic** in the displayed menu to enter the Harmonic Setting Interface, as shown in the figure below.

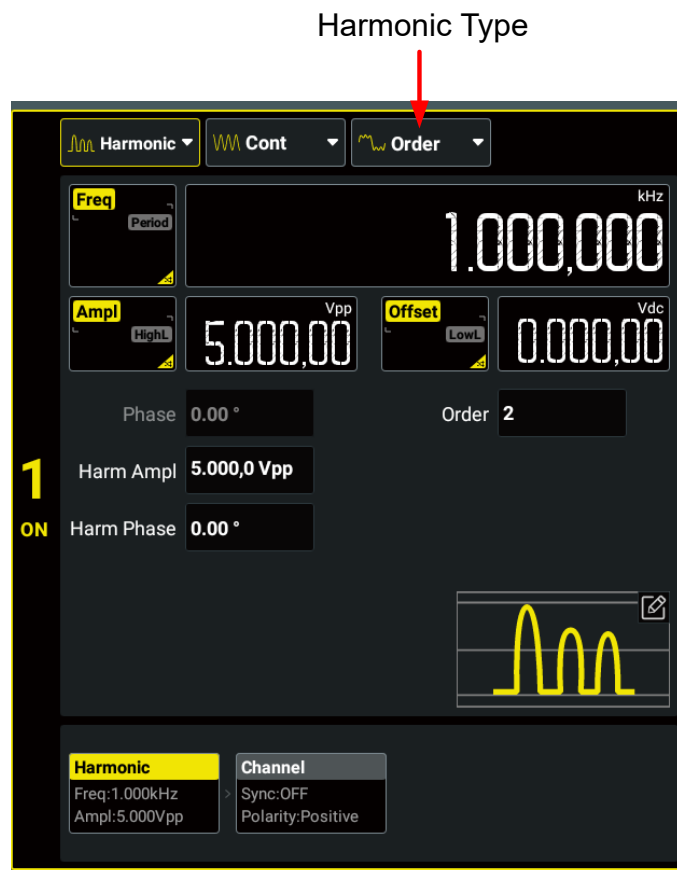

Figure 5.2 Harmonic Setting Interface

### Fundamental Waveform Parameters

DG5000 Pro allows you to set the frequency/period, amplitude/high level, and offset/low level for fundamental waveforms. You can refer to *To Output Sine Wave* to set the above parameters. Note that  $V_{rms}$  and  $dBm$  are not available for the unit of the fundamental amplitude.

**TIP**

The max. fundamental frequency ( $F_{fund}$ ) is limited by the harmonic order ( $M$ ) and max. harmonic frequency ( $F_{max}$ ):  $F_{fund} = (2 \times F_{max} \div M)$ . Changing the harmonic order may modify the fundamental frequency. For the max. harmonic frequency ( $F_{max}$ ) of different models, refer to [Table 5.1 Range of Continuous Waveform Frequency](#).

**Harmonic Type**

Click or tap the "Harmonic Type" drop-down button to select the desired type.

- **Order:** only outputs the fundamental waveform and the specified harmonic component. For example, if the **Order** is set to 5, the instrument will output the fundamental waveform and the 5th harmonic component.
- **Combine:** outputs harmonics with multiple harmonic components.

In this mode, 20 bits binary data are used to represent the output status of the 20 orders of harmonics respectively; wherein, 1 represents enabling the output of the corresponding harmonic and 0 represents disabling the output of the corresponding harmonic. Click or tap the **User** input field and use the pop-up virtual keypad to set the value of each data bit. Note that the leftmost bit representing fundamental waveform is always X and can not be modified. For example, set the 20 bits data to X001 0000 0000 0000 0001 and then fundamental waveform as well as 4th and 20th orders of harmonics will be output.

**Order Harmonic**

Click or tap the "Harmonic Type" drop-down button to select "Order" to enter the setting menu. Click or tap the **Order** input field to set the order. It ranges from 2 (default) to 20. After that, you can set the harmonic amplitude and phase.

- **Harmonic Amplitude:** click or tap the **Harm Ampl** input field to set the amplitude with the pop-up virtual keypad.
- **Harmonic Phase:** click or tap the **Harm Phase** input field to set the phase with the pop-up virtual keypad.

**Combine Harmonic**

Click or tap the "Harmonic Type" drop-down button to select "Combine" to enter the setting menu. Click or tap the **User** input field to set the user-defined orders of harmonics. After that, you can click or tap the harmonic editing table to set the amplitude and phase in the pop-up menu.





Table Editing

SN 2

| SN | Amplitude   | Phase  |
|----|-------------|--------|
| 2  | 5,000,0 Vpp | 0.00 ° |
| 3  | 5,000,0 Vpp | 0.00 ° |
| 4  | 5,000,0 Vpp | 0.00 ° |
| 5  | 5,000,0 Vpp | 0.00 ° |
| 6  | 5,000,0 Vpp | 0.00 ° |
| 7  | 5,000,0 Vpp | 0.00 ° |
| 8  | 5,000,0 Vpp | 0.00 ° |

Figure 5.3 Table Editing Menu

- **Harmonic Amplitude:** click or tap any cell in the **Amplitude** column and use the pop-up virtual keypad to set the amplitude for the harmonic with the specified order.
- **Harmonic Phase:** click or tap any cell in the **Phase** column and use the pop-up virtual keypad to set the phase for the harmonic with the specified order.



**TIP**

You can click or tap the **SN** input field to set the order to locate the specified harmonic quickly.

# 6 Modulation

DG5000 Pro allows you to output various modulated waveforms. Available modulation types include AM, FM, PM, ASK, FSK, PSK, PWM, and SUM. Both internal and external modulation sources are available for modulating waveforms.

Click or tap the "Output Mode" drop-down button to select "Mod" and access the interface as shown in the figure below. You can click or tap one of the tabs at the bottom to access the Continuous (Carrier) Setting Interface, Modulation Setting Interface, or Channel Setup Interface. For Continuous (Carrier) Setting Interface and Channel Setup Interface, please refer to *Continuous* and *Channel Setup* respectively. This chapter only describes the modulation settings.

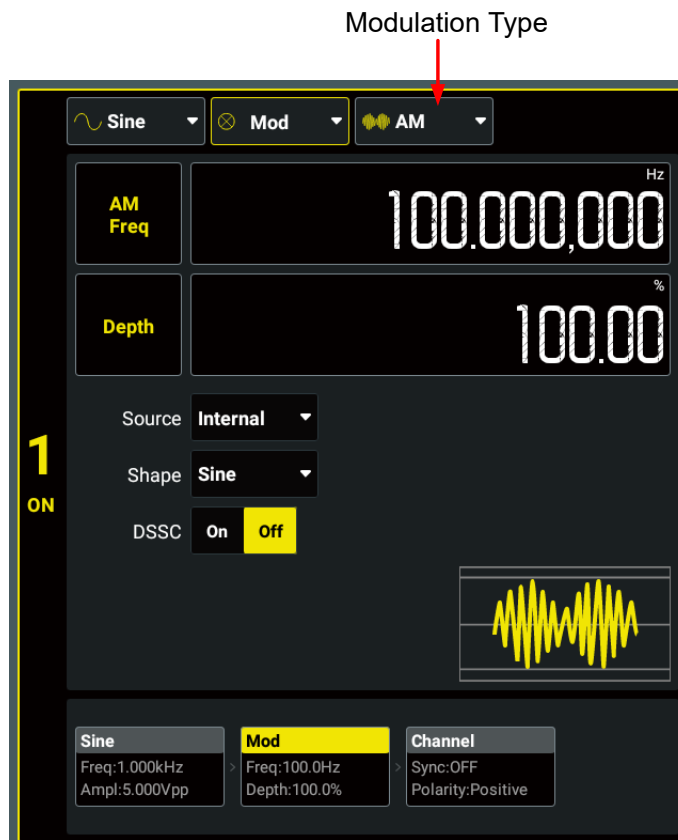

**Figure 6.1 Modulation Setting Interface**

The following table shows the range of the frequency for different carriers in the Modulation mode.

**Table 6.1 Carrier Frequency Range (Modulation Mode)**

| Waveform         | DG5252 Pro/<br>DG5254 Pro/<br>DG5258 Pro | DG5352 Pro/<br>DG5354 Pro/<br>DG5358 Pro | DG5502 Pro/<br>DG5504 Pro/<br>DG5508 Pro |
|------------------|------------------------------------------|------------------------------------------|------------------------------------------|
| Sine             | 1 $\mu$ Hz to 250 MHz                    | 1 $\mu$ Hz to 350 MHz                    | 1 $\mu$ Hz to 350 MHz                    |
| Square           | 1 $\mu$ Hz to 120 MHz                    | 1 $\mu$ Hz to 120 MHz                    | 1 $\mu$ Hz to 120 MHz                    |
| Ramp             | 1 $\mu$ Hz to 2.5 MHz                    | 1 $\mu$ Hz to 2.5 MHz                    | 1 $\mu$ Hz to 2.5 MHz                    |
| Pulse (PWM only) | 1 $\mu$ Hz to 120 MHz                    | 1 $\mu$ Hz to 120 MHz                    | 1 $\mu$ Hz to 120 MHz                    |
| Arb              | 1 $\mu$ Hz to 100 MHz                    | 1 $\mu$ Hz to 100 MHz                    | 1 $\mu$ Hz to 100 MHz                    |

## 6.1 Amplitude Modulation (AM)

In Amplitude Modulation (AM), a modulated waveform consists of a carrier waveform and a modulating waveform. The amplitude of the carrier waveform is varied by the instantaneous voltage of the modulating waveform. In the "Modulation Setting Interface" ([Figure 6.1](#)), click or tap the "Modulation Type" drop-down button to select "AM" and set its parameters.

### Carrier Waveform

Available AM carrier waves include sine (default), square, ramp, and Arb. Click or tap the "Basic Wave Type" drop-down button or press the corresponding front-panel waveform selection key to select the desired carrier waveform shape. Enter the Carrier Setting Interface and see [Continuous](#) to set the carrier parameters. The available frequency range varies for different carriers in the Modulation mode. For details, refer to [Table 6.1 Carrier Frequency Range \(Modulation Mode\)](#).

### Modulating Waveform

The instrument accepts an internal or external signal as the modulation source. Click or tap the **Source** drop-down button to select "Internal" or "External".

- **Internal Source**

After "Internal" is selected, you can click or tap the **Shape** drop-down button to select the modulating waveform shape. Available shapes include:

- Sine
- Square with 50% duty cycle
- Triangle with 50% symmetry
- UpRamp with 100% symmetry

- DnRamp with 0% symmetry
- Noise - white gaussian noise
- Arb: When the "Shape" is set to Arb, you can click or tap the **Shape** input field to set the Arb type.
- **External Source**

After "External" is selected, **AM Freq** is grayed out and disabled. The instrument accepts an external modulation source applied to the front-panel **[Mod In]** connector. At this time, the amplitude of the modulated waveform is controlled by the  $\pm 5$  V signal level present on the connector.



#### NOTE

How to realize the intermodulation between two channels? The following example takes the output signal of CH2 as the AM modulating waveform of CH1.

1. Connect the CH2 output terminal to the front-panel **[Mod In]** connector of CH1 using the BNC-to-SMB cable.
2. Select CH1 and set the output mode to "Mod". Select the desired modulation type and set the corresponding parameters. Set the **Source** to "External".
3. Select CH2 and set the desired shape as well as the corresponding parameters.
4. Turn on the CH1 and CH2 outputs.

#### Modulation Frequency

After the internal modulation source is selected, click or tap the **AM Freq** input field and set the modulation frequency with the pop-up numeric keypad. The available range is from 2 mHz to 1 MHz, and the default is 100 Hz. The resolution is 1 mHz.



#### TIP

When an external modulation source is selected, this setting is grayed out and disabled.

#### Modulation Depth

Modulation depth is a percentage that represents the amplitude variation. Click or tap the **Depth** input field to set the modulation depth. AM depth ranges from 0% to 120% (limited by the amplitude). The default is 100%, and the resolution is 0.01%.

- At 0% depth, the amplitude is one-half of the carrier's amplitude setting.
- At 100% depth, the amplitude is identical to the carrier's amplitude setting.
- At greater than 100% depth, the output amplitude will not exceed the maximum output amplitude allowed by the current output frequency (refer to [Table 5.2 Range of Amplitude](#)).

When an external modulation source is selected, the AM modulation amplitude is also controlled by the  $\pm 5$  V signal level on the front-panel **[Mod In]** connector. For example, if the modulation depth is set to 100%, then the output will be at the maximum amplitude when the modulating signal is at +5 V. The output will be at the minimum amplitude when the modulating signal is at -5 V.

### DSSC

DG5000 Pro supports two forms of amplitude modulation, Normal and Double Sideband Suppressed Carrier (DSSC). In "normal" AM, the modulated wave consists of the carrier wave and two sidebands. Such a modulation is inefficient because the carrier wave carries no information. If this carrier is suppressed and the saved power is distributed to the two sidebands, then such a process is called Double Sideband Suppressed Carrier (DSSC).

By default, the "DSSC" is off. Click or tap the **DSSC** on/off switch to turn on or off the DSSC function.

## 6.2 Frequency Modulation (FM)

In Frequency Modulation (FM), a modulated waveform consists of a carrier waveform and a modulating waveform. The frequency of the carrier waveform is varied by the instantaneous voltage of the modulating waveform. In the "Modulation Setting Interface" ([Figure 6.1](#)), click or tap the "Modulation Type" drop-down button to select "FM" and set its parameters.

### Carrier Waveform

Available FM carrier waves include sine (default), square, ramp, and Arb. Click or tap the "Basic Wave Type" drop-down button or press the corresponding front-panel waveform selection key to select the desired carrier waveform shape. Enter the Carrier Setting Interface and see [Continuous](#) to set the carrier parameters. The available frequency range varies for different carriers in the Modulation mode. For details, refer to [Table 6.1 Carrier Frequency Range \(Modulation Mode\)](#).

### Modulating Waveform

The instrument accepts an internal or external signal as the modulation source. Click or tap the **Source** drop-down button to select "Internal" or "External".

- **Internal Source**

After "Internal" is selected, you can click or tap the **Shape** drop-down button to select the modulating waveform shape. Available shapes include:

- Sine
- Square with 50% duty cycle
- Triangle with 50% symmetry

- UpRamp with 100% symmetry
  - DnRamp with 0% symmetry
  - Noise - white gaussian noise
  - Arb: When the "Shape" is set to Arb, you can click or tap the **Shape** input field to set the Arb type.
- **External Source**

After "External" is selected, **FM Freq** is grayed out and disabled. The instrument accepts an external modulation source applied to the front-panel **[Mod In]** connector. At this time, the FM frequency deviation is controlled by the  $\pm 5$  V signal level present on the connector.

### Modulation Frequency

After the internal modulation source is selected, click or tap the **FM Freq** input field and set the modulation frequency with the pop-up numeric keypad. The available range is from 2 mHz to 1 MHz, and the default is 100 Hz. The resolution is 1 mHz.

#### TIP

When an external modulation source is selected, this setting is grayed out and disabled.

### Frequency Deviation

It represents the peak variation in frequency of the modulated waveform from the carrier frequency. Click or tap the **Freq Dev** input field to set the frequency deviation. The minimum frequency deviation is 0 Hz.

- For FM, the frequency deviation must always be less than or equal to the carrier frequency minus 1  $\mu$ Hz.
- The frequency deviation plus the carrier frequency must be less than or equal to the selected carrier's maximum frequency.

When an external modulation source is selected, the frequency deviation is controlled by the  $\pm 5$  V signal level on the front-panel **[Mod In]** connector. For example, if the frequency deviation is set to 1 kHz, the +5 V signal level corresponds to a 1 kHz increase in frequency. Lower external signal levels produce less deviation and negative signal levels reduce the frequency below the carrier frequency.

## 6.3 Phase Modulation (PM)

In Phase Modulation (PM), a modulated waveform consists of a carrier waveform and a modulating waveform. The phase of the carrier waveform is varied by the instantaneous voltage of the modulating waveform. In the "Modulation Setting

Interface" ([Figure 6.1](#)), click or tap the "Modulation Type" drop-down button to select "PM" and set its parameters.

### Carrier Waveform

Available PM carrier waves include sine (default), square, ramp, and Arb. Click or tap the "Basic Wave Type" drop-down button or press the corresponding front-panel waveform selection key to select the desired carrier waveform shape and access the setup interface. To configure different carrier waveforms, please refer to [Continuous](#). The available frequency range varies for different carriers in the Modulation mode. For details, refer to [Table 6.1 Carrier Frequency Range \(Modulation Mode\)](#).

### Modulating Waveform

The instrument accepts an internal or external signal as the modulation source. Click or tap the **Source** drop-down button to select "Internal" or "External".

- **Internal Source**

After "Internal" is selected, you can click or tap the **Shape** drop-down button to select the modulating waveform shape. Available shapes include:

- Sine
- Square with 50% duty cycle
- Triangle with 50% symmetry
- UpRamp with 100% symmetry
- DnRamp with 0% symmetry
- Noise - white gaussian noise
- Arb: When the "Shape" is set to Arb, you can click or tap the **Shape** input field to set the Arb type.

- **External Source**

After "External" is selected, **PM Freq** is grayed out and disabled. The instrument accepts an external modulation source applied to the front-panel **[Mod In]** connector. At this time, the PM phase deviation is controlled by the  $\pm 5$  V signal level present on the connector.

### Modulation Frequency

After the internal modulation source is selected, click or tap the **PM Freq** input field and set the modulation frequency with the pop-up numeric keypad. The available range is from 2 mHz to 1 MHz, and the default is 100 Hz. The resolution is 1 mHz.

**TIP**

When an external modulation source is selected, this setting is grayed out and disabled.

**Phase Deviation**

The phase deviation represents the peak variation in phase of the modulated waveform from the carrier waveform. Click or tap the **PM Dev** input field to set the phase deviation. It ranges from 0° to 360°, and the default is 90°. The resolution is 0.01°.

When an external modulation source is selected, the phase deviation is controlled by the  $\pm 5$  V signal level on the front-panel **[Mod In]** connector. For example, if the phase deviation is set to 180°, the +5 V signal level corresponds to a 180° phase shift. Lower external signal levels produce less deviation.

## 6.4 Amplitude Shift Keying (ASK)

With Amplitude Shift Keying (ASK), you can configure the instrument to "shift" its output amplitude between two preset values (called the "carrier amplitude" and the "modulation amplitude"). In the "Modulation Setting Interface" ([Figure 6.1](#)), click or tap the "Modulation Type" drop-down button to select "ASK" and set its parameters.

**Carrier Waveform**

Available ASK carrier waves include sine (default), square, ramp, and Arb. Click or tap the "Basic Wave Type" drop-down button or press the corresponding front-panel waveform selection key to select the desired carrier waveform shape.

In the Carrier (Continuous) Setting Interface, click or tap the **Ampl/HighL** button or press the front-panel  key to set the parameter to "Ampl". Click or tap its input field and use the pop-up numeric keypad to set the carrier amplitude. For carrier amplitude setting methods and available range, please refer to [Continuous](#). The available frequency range varies for different carriers in the Modulation mode. For details, refer to [Table 6.1 Carrier Frequency Range \(Modulation Mode\)](#).

**Modulation Source**

The instrument accepts an internal or external signal as the modulation source. Click or tap the **Source** drop-down button to select "Internal" or "External".

- **Internal Source**

When "Internal" is selected, the instrument uses a square wave with 50% duty cycle as the ASK modulation source. At this time, the output amplitude "shifts" between "carrier amplitude" and "modulation amplitude". The shift rate is determined by "ASK Rate".



- **External Source**

When "External" is selected, the instrument accepts an external modulation signal from the specified port as the ASK modulation source. You can click or tap the **Port** drop-down button to select the input port.

- Front port: The instrument accepts an external modulation signal from the front-panel **[Mod In]** connector. The modulation rate is up to 100 kHz.
- Rear port: The instrument accepts an external modulation signal from the rear-panel **[AUX IN]** connector. The modulation rate is up to 10 MHz.

### ASK Rate

ASK rate is the rate at which the output amplitude "shifts" between the carrier amplitude and modulation amplitude when an internal modulation source is used. Click or tap the **ASK Rate** input field and use the pop-up numeric keypad to set the rate. The available range is from 2 mHz to 1 MHz, and the default is 100 Hz. The resolution is 1 mHz.



### TIP

When the external modulation source is selected, this setting is grayed out and disabled.

### Modulation Amplitude

Click or tap the **ASK Ampl** input field and use the pop-up numeric keypad to set the modulation amplitude. The available range of modulation amplitude is consistent with the range of basic waveform amplitude (see *Table 5.2 Range of Amplitude*) and the default is 2 Vpp.

### Polarity

Click or tap the **Polarity** drop-down button to select "Positive" or "Negative" to control the amplitude output. The default is "Positive".

- **Positive:** when the internal/external modulation signal is a logic low level, the carrier amplitude is output; when the signal is a logic high level, the modulation amplitude is output.
- **Negative:** when the internal/external modulation signal is a logic low level, the modulation amplitude is output; when the signal is a logic high level, the carrier amplitude is output.

## 6.5 Frequency Shift Keying (FSK)

With Frequency Shift Keying (FSK), you can configure the instrument to "shift" its output frequency between two preset values (called the "carrier frequency" and the "hop frequency"). In the "Modulation Setting Interface" (*Figure 6.1*), click or tap the "Modulation Type" drop-down button to select "FSK" and set its parameters.

## Carrier Waveform

Available FSK carrier waves include sine (default), square, ramp, and Arb. Click or tap the "Basic Wave Type" drop-down button or press the corresponding front-panel waveform selection key to select the desired carrier waveform shape.

In the Carrier (Continuous) Setting Interface, click or tap the **Freq/Period** button or press the front-panel  to set the parameter to "Freq". Click or tap its input field and use the pop-up numeric keypad to set the carrier frequency. The available frequency range varies for different carriers in the Modulation mode. For details, refer to [Table 6.1 Carrier Frequency Range \(Modulation Mode\)](#).

## Modulation Source

The instrument accepts an internal or external signal as the modulation source. Click or tap the **Source** drop-down button to select "Internal" or "External".

- **Internal Source**

When "Internal" is selected, the instrument uses a square wave with 50% duty cycle as the FSK modulation source. At this time, the output frequency "shifts" between "carrier frequency" and "hop frequency". The shift rate is determined by "FSK Rate".

- **External Source**

When "External" is selected, the instrument accepts an external modulation signal from the specified port as the FSK modulation source. You can click or tap the **Port** drop-down button to select the input port.

- Front port: The instrument accepts an external modulation signal from the front-panel **[Mod In]** connector. The modulation rate is up to 100 kHz.
- Rear port: The instrument accepts an external modulation signal from the rear-panel **[AUX IN]** connector. The modulation rate is up to 10 MHz.

## FSK Rate

FSK rate is the rate at which the output frequency "shifts" between the carrier frequency and the hop frequency when an internal modulation source is used. Click or tap the **FSK Rate** input field and use the pop-up numeric keypad to set the rate. The available range is from 2 mHz to 1 MHz, and the default is 100 Hz.

## TIP

When the external modulation source is selected, this setting is grayed out and disabled.



### Hop Frequency

Click or tap the **Hop Freq** input field and use the pop-up numeric keypad to set the hop frequency. The range of hop frequency is related to the instrument model and wave type. For details, refer to [Table 5.1 Range of Continuous Waveform Frequency](#).

### Polarity

Click or tap the **Polarity** drop-down button to select "Positive" or "Negative" to control the frequency output. The default is "Positive".

- **Positive:** when the internal/external modulation signal is a logic low level, the carrier frequency is output; when the signal is a logic high level, the hop frequency is output.
- **Negative:** when the internal/external modulation signal is a logic low level, the hop frequency is output; when the signal is a logic high level, the carrier frequency is output.

## 6.6 Phase Shift Keying (PSK)

In Phase Shift Keying (PSK), you can configure the instrument to "shift" its output phase between two preset phase settings ("carrier phase" and "modulation phase"). In the "Modulation Setting Interface" ([Figure 6.1](#)), click or tap the "Modulation Type" drop-down button to select "PSK" and set its parameters.

### Carrier Waveform

Available PSK carrier waves include sine (default), square, ramp, and Arb. Click or tap the "Basic Wave Type" drop-down button or press the corresponding front-panel waveform selection key to select the desired carrier waveform shape.

In the Carrier (Continuous) Setting Interface, click or tap the "Phase" input field and use the pop-up numeric keypad to set the starting phase. It ranges from  $-360^\circ$  to  $360^\circ$ , and the default is  $0^\circ$ . The resolution is  $0.01^\circ$ . The available frequency range varies for different carriers in the Modulation mode. For details, refer to [Table 6.1 Carrier Frequency Range \(Modulation Mode\)](#).

### Modulation Source

The instrument accepts an internal or external signal as the modulation source. Click or tap the **Source** drop-down button to select "Internal" or "External".

- **Internal Source**

When "Internal" is selected, the instrument uses a square wave with 50% duty cycle as the PSK modulation source. At this time, the output phase "shifts" between "carrier phase" and "modulation phase". The shift rate is determined by "PSK Rate".

- **External Source**

When "External" is selected, the instrument accepts an external modulation signal from the specified port as the PSK modulation source. You can click or tap the **Port** drop-down button to select the input port.

- Front port: The instrument accepts an external modulation signal from the front-panel **[Mod In]** connector. The modulation rate is up to 100 kHz.
- Rear port: The instrument accepts an external modulation signal from the rear-panel **[AUX IN]** connector. The modulation rate is up to 10 MHz.

### PSK Rate

PSK rate is the rate at which the output phase "shifts" between the carrier phase and modulation phase when an internal modulation source is used. Click or tap the **PSK Rate** input field and use the pop-up numeric keypad to set the rate. The available range is from 2 mHz to 1 MHz, and the default is 100 Hz. The resolution is 1 mHz.

### TIP

When the external modulation source is selected, this setting is grayed out and disabled.

### Modulation Phase

Click or tap the **Phase** input field and use the pop-up numeric keypad to set the modulation phase. It ranges from 0° to 360°, and the default is 180°. The resolution is 0.01°.

### Polarity

Click or tap the **Polarity** drop-down button to select "Positive" or "Negative" to control the phase output. The default is "Positive".

- **Positive:** when the internal/external modulation signal is a logic low level, the carrier phase is output; when the signal is a logic high level, the modulation phase is output.
- **Negative:** when the internal/external modulation signal is a logic low level, the modulation phase is output; when the signal is a logic high level, the carrier phase is output.

## 6.7 Pulse Width Modulation (PWM)

For Pulse Width Modulation (PWM), the pulse width of the output signal is varied by the instantaneous voltage of the modulating waveform. The amount by which the pulse width varies is called the width deviation.

### TIP

To select the PWM function, first click or tap the "Basic Wave Type" drop-down button to select "Pulse" and then set the "Output Mode" to "Mod". The modulation type will be set to "PWM" automatically. Refer to the following section to set the other modulation parameters.

### Carrier Waveform

PWM is only available for the Pulse waveform. Click or tap the "Basic Wave Type" drop-down button to select "Pulse" or press the front-panel  key to set the carrier waveform to Pulse. For pulse width/duty cycle setting, refer to *To Output Pulse*.

### Modulation Source

The instrument accepts an internal or external signal as the modulation source. Click or tap the **Source** drop-down button to select "Internal" or "External".

- **Internal Source**

After "Internal" is selected, you can click or tap the **Shape** drop-down button to select the modulating waveform shape. Available shapes include:

- Sine
- Square with 50% duty cycle
- Triangle with 50% symmetry
- UpRamp with 100% symmetry
- DnRamp with 0% symmetry
- Noise - white gaussian noise
- Arb: When the "Shape" is set to Arb, you can click or tap the **Shape** input field to set the Arb type.

- **External Source**

After "External" is selected, **PWM Freq** is grayed out and disabled. The instrument accepts an external modulation source applied to the front-panel **[Mod In]** connector. At this time, the PWM width/duty cycle deviation is controlled by the  $\pm 5$  V signal level present on the connector.

### Modulation Frequency

After the internal modulation source is selected, click or tap the **PWM Freq** input field and set the modulation frequency with the pop-up numeric keypad. The available range is from 2 mHz to 1 MHz, and the default is 100 Hz.

#### TIP

When an external modulation source is selected, this setting is disabled.



## Width Deviation/Duty Cycle Deviation

PWM deviation represents the variation of the modulated waveform pulse width relative to the original pulse width. You can use time (width deviation) or duty cycle (duty cycle deviation) to set the PWM deviation. This setting is subject to the *Pulse Width/Duty Cycle* setting in Carrier (Pulse) setting. For example, if "Width" is selected for *Pulse Width/Duty Cycle* of the Pulse setting, then the PWM deviation setting is automatically set to "Width Dev".

- **Width Deviation**

Width deviation represents the amount by which the pulse width of the modulated waveform varies from the original pulse width. The unit is s. For example, if you specify a pulse width as 10 s and width deviation as 5 s, the pulse width of the modulated waveform varies from 5 s to 15 s under the control of the modulating signal.

Click or tap the **Duty Dev/Width Dev** button to set the parameter to "Width Dev". "Width Dev" is now highlighted. Click or tap its input field to set the width deviation. The range of the width deviation is limited by the pulse width, rising edge time, and falling edge time of the pulse waveform.

- **Duty Cycle Deviation**

Duty cycle deviation represents the amount by which the pulse width of the modulated waveform varies from the original pulse width. The unit is the percentage of the waveform period. For example, if you specify a pulse duty cycle as 10% and duty cycle deviation as 5%, the duty cycle of the modulated waveform varies from 5% to 15% under the control of the modulating signal.

Click or tap the **Duty Dev/Width Dev** button to set the parameter to "Duty Dev". "Duty Dev" is now highlighted. Click or tap its input field to set the duty cycle deviation. The duty cycle deviation ranges from 0% to 49.99%, and is limited by the pulse width, duty cycle, and edge time of the pulse waveform.

When an external modulation source is selected, the width deviation (or duty cycle deviation) is controlled by the  $\pm 5$  V signal level on the front-panel **[Mod In]** connector. For example, if the width deviation is set to 10 s, the +5 V signal level corresponds to a 10 s deviation.

## 6.8 SUM Modulation

When the waveform summing function is enabled, you can add a specified waveform to the carrier. In the "Modulation Setting Interface" (*Figure 6.1*), click or tap the "Modulation Type" drop-down button to select "SUM" and set its parameters.

### Carrier Waveform

Available carrier waves include sine (default), square, ramp, and Arb. Click or tap the "Basic Wave Type" drop-down button or press the corresponding front-panel

waveform selection key to select the desired carrier waveform shape. Enter the Carrier Setting Interface and see *Continuous* to set the carrier parameters. The available frequency range varies for different carriers in the Modulation mode. For details, refer to *Table 6.1 Carrier Frequency Range (Modulation Mode)*.

### Sum Waveform

Click or tap the **Waveform** drop-down button to select the waveform to be added to the current waveform. Available waveform shapes include:

- Sine
- Square with 50% duty cycle
- Triangle with 50% symmetry
- UpRamp with 100% symmetry
- DnRamp with 0% symmetry
- Noise - white gaussian noise
- Arb: When the "Shape" is set to Arb, you can click or tap the **Waveform** input field to set the Arb type.

### Sum Frequency

It sets the frequency of the waveform to be added to the current continuous waveform. Click or tap the **SUM Freq** input field and use the pop-up virtual keypad to set the frequency. The range of the Sum frequency is from 2 mHz to 1 MHz.

### Sum Ratio

It sets the ratio of the amplitude of the waveform to be added relative to the amplitude of the current waveform. Output Amplitude of Summed Waveform = Carrier Amplitude x (1 + Sum Ratio). Click or tap the **SUM Ratio** input field and use the pop-up virtual keypad to set the ratio. The available range is from 0% to 100%, and the default is 50%. The upper limit of the sum ratio is limited by the maximum peak of the current output waveform (*Table 5.2 Range of Amplitude*).

## 7 Sweep

In frequency sweep mode, the instrument moves from the start frequency to the stop frequency within a specified sweep time. You can sweep up or down in frequency, with linear, logarithmic, or step sweep types. It allows you to set the "Mark" frequency, start/stop hold time, and return time. It provides trigger sources including internal, external, and manual sources. You can sweep sine, square, ramp, and Arb.

Click or tap the "Output Mode" drop-down button to select "Sweep" and access the interface as shown in the figure below. You can click or tap one of the tabs at the bottom to access the Continuous Setting Interface, Sweep Setting Interface, or Channel Setup Interface. For Continuous Setting Interface and Channel Setup Interface, please refer to *Continuous* and *Channel Setup* respectively. This chapter only describes the sweep settings.

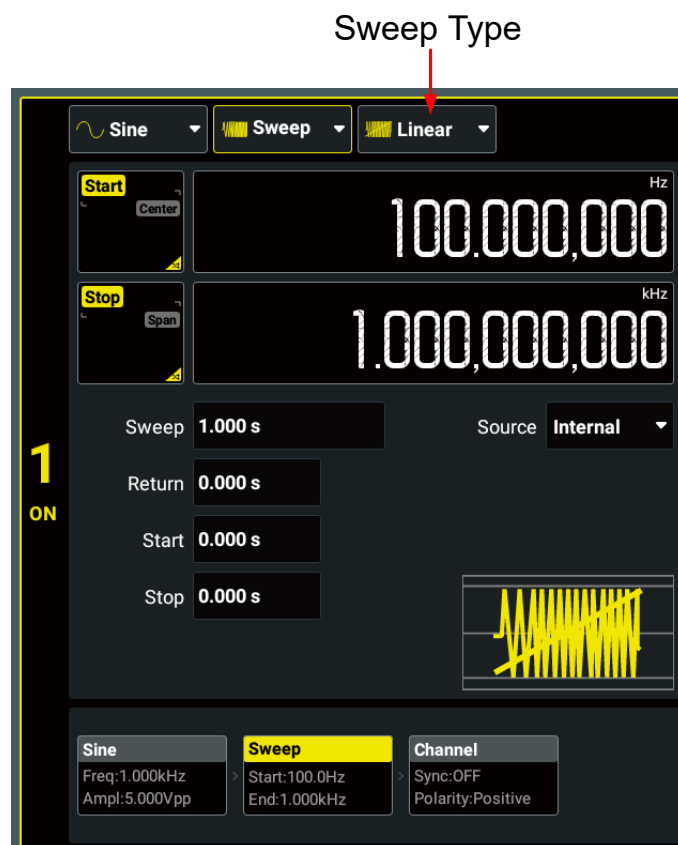

Figure 7.1 Sweep Setting Interface

### 7.1 Sweep Type

This instrument provides three sweep types: Linear, Log, and Step. The default is Linear. Click or tap the "Sweep Type" drop-down button to select "Linear", "Log", or "Step".



### Linear Sweep

The instrument varies the output frequency linearly during the sweep, changing the output frequency by a constant number of Hz per second. It is characterized by "Start Frequency", "Stop Frequency", and "Sweep Time".

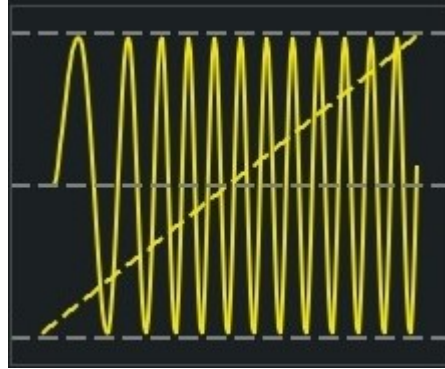

Figure 7.2 Linear Sweep

### Logarithmic Sweep

The instrument varies the output frequency logarithmically during the sweep, changing the frequency by a constant number of octaves. It is characterized by "Start Frequency", "Stop Frequency", and "Sweep Time".

Define the start frequency, stop frequency, sweep time as  $F_{start}$ ,  $F_{stop}$ , and  $T_{sweep}$ . The function of logarithmic sweep is  $F = P^T$ ; wherein,  $P$  and  $T$  can be expressed in the following equations:

$$P = 10^{\lg(F_{stop}/F_{start})/T_{sweep}}$$

$$T = t + \lg(F_{start})/\lg(P)$$

In the equations above,  $t$  is the duration time after the sweep starts, ranging from 0 to  $T_{sweep}$ ;  $F$  is the current instantaneous frequency.

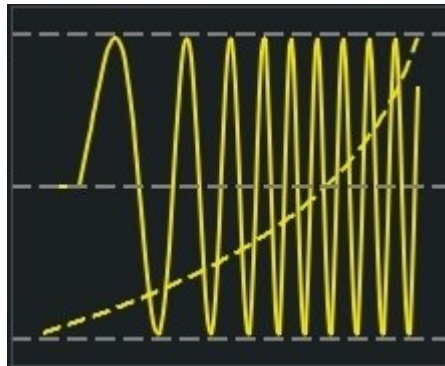

Figure 7.3 Logarithmic Sweep

## Step Sweep

The instrument "steps" through a list of frequencies during the sweep. The period that the output signal dwells on each frequency is determined by "Sweep Time" and "Step Number".

When the sweep type is set to "Step", click or tap the **Step Num** input field to set the number of steps. It ranges from 2 (default) to 1024.

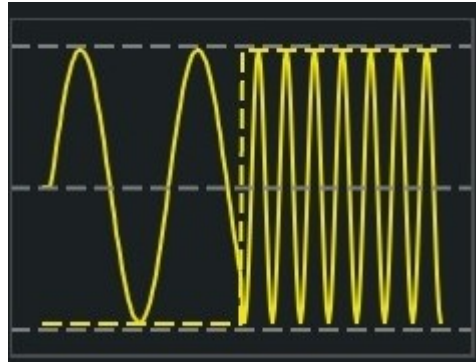

Figure 7.4 Step Sweep

## 7.2 Start Frequency and Stop Frequency

The start frequency and stop frequency set the sweep's upper and lower frequency bounds. The sweep begins at the start frequency, sweeps to the stop frequency, and then resets back to the start frequency.

- To sweep up in frequency, set the start frequency less than the stop frequency.
- To sweep down in frequency, set the opposite relationship.
- To sweep in a fixed frequency, set the same start frequency and stop frequency.

After enabling the sweep mode, click or tap the **Start/Center** button to set the parameter to "Start". "Start" is now highlighted. This operation also toggles the parameter of the **Stop/Span** button to "Stop". Click or tap the corresponding input field and use the pop-up numeric keypad to set the start frequency and stop frequency. By default, the start frequency is 100 Hz and the stop frequency is 1 kHz. The range of the start/stop frequency is related to the instrument model and wave type.

Table 7.1 Sweep Start/Stop Frequency Range

| Waveform | DG5252 Pro/DG5254 Pro/DG5258 Pro | DG5352 Pro/DG5354 Pro/DG5358 Pro | DG5502 Pro/DG5504 Pro/DG5508 Pro |
|----------|----------------------------------|----------------------------------|----------------------------------|
| Sine     | 1 $\mu$ Hz to 250 MHz            | 1 $\mu$ Hz to 350 MHz            | 1 $\mu$ Hz to 350 MHz            |
| Square   | 1 $\mu$ Hz to 120 MHz            | 1 $\mu$ Hz to 120 MHz            | 1 $\mu$ Hz to 120 MHz            |

| Waveform | DG5252 Pro/DG5254 Pro/DG5258 Pro | DG5352 Pro/DG5354 Pro/DG5358 Pro | DG5502 Pro/DG5504 Pro/DG5508 Pro |
|----------|----------------------------------|----------------------------------|----------------------------------|
| Ramp     | 1 $\mu$ Hz to 2.5 MHz            | 1 $\mu$ Hz to 2.5 MHz            | 1 $\mu$ Hz to 2.5 MHz            |
| Arb      | 1 $\mu$ Hz to 100 MHz            | 1 $\mu$ Hz to 100 MHz            | 1 $\mu$ Hz to 100 MHz            |

After the start/stop frequency is modified, the instrument will sweep from the specified start frequency again.

## 7.3 Center Frequency and Frequency Span

You can also set the sweep frequency boundaries of the sweep using a center frequency and frequency span.

- Center Frequency = (Start Frequency + Stop Frequency)/2
- Frequency Span = Stop Frequency - Start Frequency

After enabling the sweep mode, click or tap the **Start/Center** button to set the parameter to "Center". "Center" is now highlighted. This operation also toggles the parameter of the **Stop/Span** button to "Span". Click or tap the corresponding input field and use the pop-up numeric keypad to set the center frequency or frequency span. By default, the center frequency is 550 Hz and the frequency span is 900 Hz. The ranges of center frequency and frequency span vary for different waveforms. Also, they are limited to each other.

The range of frequency span is affected by the center frequency. Define the upper limit of the start/stop frequency as  $F_{\max}$  and the lower limit of the start/stop frequency as  $F_{\min}$  ([Table 7.1 Sweep Start/Stop Frequency Range](#)).  $F_m = (F_{\max} - F_{\min})/2$ .

- When Center Frequency  $\leq F_m$ , the range of the Frequency Span is  $\pm 2 \times (\text{Center Frequency} - F_{\min})$ .
- When Center Frequency  $> F_m$ , the range of the Frequency Span is  $\pm 2 \times (F_{\max} - \text{Center Frequency})$ .

Take sine wave as an example.  $F_{\min}$  is 1  $\mu$ Hz,  $F_{\max}$  is 350 MHz, and  $F_m$  is about 175 MHz. If the center frequency is 100 MHz, the frequency span range is  $\pm 2 \times (100 \text{ MHz} - 1 \mu\text{Hz}) = \pm 200 \text{ MHz}$ ; if the center frequency is 300 MHz, the frequency span range is  $\pm 2 \times (350 \text{ MHz} - 300 \text{ MHz}) = \pm 100 \text{ MHz}$ .



### TIP

To sweep up in frequency, set a positive frequency span; to sweep down, set a negative frequency span.

## 7.4 Sweep Time

Sweep time specifies the time required to sweep from the start frequency to the stop frequency, as shown in the figure below.

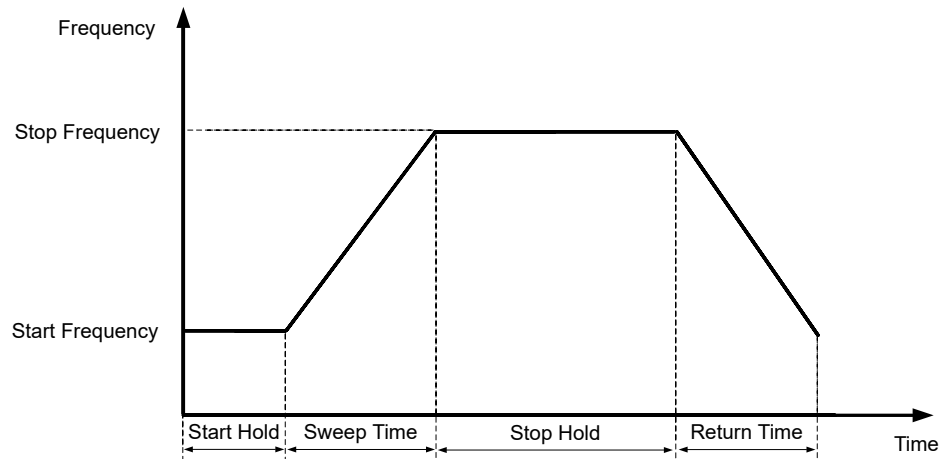

Figure 7.5 Sweep

Click or tap the **Sweep** input field and use the pop-up numeric keypad to set the sweep time. The default sweep time is 1 s and the resolution is 1 ms. The sweep time ranges from 1 ms to 250,000 s. The sweep time is related to the sweep type, trigger source, start hold time, return time, and stop hold time.  $T_p = \text{Start Hold Time} + \text{Sweep Time} + \text{Stop Hold Time} + \text{Return Time}$ :

- **Linear Sweep:**
  - Internal trigger:  $T_p + 1 \text{ ms} \leq 8,000 \text{ s}$
  - Manual trigger/external trigger:  $T_p \leq 250,000 \text{ s}$
- **Log Sweep/Step Sweep:**  $T_p \leq 500 \text{ s}$

After the sweep time is modified, the instrument will sweep from the specified "Start Frequency" again.

## 7.5 Start/Stop Hold Time

Start hold time specifies the time for the sweep to remain at the "Start Frequency" (*Figure 7.5*). After the start hold time expires, the generator continues to sweep at varied frequencies according to the current sweep type.

Stop hold time specifies the time for the sweep to remain at the "Stop Frequency" after the generator sweeps from the "Start Frequency" to the "Stop Frequency".

You can click or tap the **Start/Stop** input field and use the pop-up numeric keypad to set the start/stop hold time. The default start/stop hold time is 0 s and the resolution

is 1 ms. The time ranges from 0 s to 3600 s and is related to the sweep type, trigger source, return time, and sweep time.  $T_p = \text{Start Hold Time} + \text{Sweep Time} + \text{Stop Hold Time} + \text{Return Time}$ :

- **Linear Sweep:**
  - Internal trigger:  $T_p + 1 \text{ ms} \leq 8,000 \text{ s}$
  - Manual trigger/external trigger:  $T_p \leq 250,000 \text{ s}$
- **Log Sweep/Step Sweep:**  $T_p \leq 500 \text{ s}$

After the start/stop hold time is modified, the instrument will sweep from the specified start frequency again.

## 7.6 Return Time

Return time specifies the time to return from the "Stop Frequency" to the "Start Frequency" (*Figure 7.5*).

Click or tap the **Return** input field and use the pop-up numeric keypad to set the return time. The default return time is 0 s and the resolution is 1 ms. The time ranges from 0 s to 3600 s and is related to the sweep type, trigger source, start hold time, stop hold time, and sweep time.  $T_p = \text{Start Hold Time} + \text{Sweep Time} + \text{Stop Hold Time} + \text{Return Time}$ :

- **Linear Sweep:**
  - Internal trigger:  $T_p + 1 \text{ ms} \leq 8,000 \text{ s}$
  - Manual trigger/external trigger:  $T_p \leq 250,000 \text{ s}$
- **Log Sweep/Step Sweep:**  $T_p \leq 500 \text{ s}$

After the return time is modified, the instrument will sweep from the specified "Start Frequency" again.

## 7.7 Sweep Trigger Source

The sweep trigger source can be internal trigger, external leading edge, external trailing edge, or manual trigger. The instrument outputs a single sweep when a trigger signal is received and waits for the next trigger. Click or tap the **Source** drop-down button and select the trigger source. The default is "Internal".

- **Internal:** The instrument outputs a continuous sweep. The trigger period is determined by the specified sweep time, return time, start hold time, and stop hold time. Note that when the internal trigger source is selected,  $\text{Trigger Period} = 1 \text{ ms} + \text{Start Hold Time} + \text{Sweep Time} + \text{Stop Hold Time} + \text{Return Time}$ .

- **Ext Leading:** The instrument receives the trigger signal from the rear-panel **[AUX IN]** connector. A sweep is generated each time a TTL pulse with leading edge is received. Note that when the external trigger source is selected, External Trigger Signal Period  $\geq 1 \text{ ms} + \text{Start Hold Time} + \text{Sweep Time} + \text{Stop Hold Time} + \text{Return Time}$ .
- **Ext Trailing:** The instrument receives the trigger signal from the rear-panel **[AUX IN]** connector. A sweep is generated each time a TTL pulse with trailing edge is received. Note that when the external trigger source is selected, External Trigger Signal Period  $\geq 1 \text{ ms} + \text{Start Hold Time} + \text{Sweep Time} + \text{Stop Hold Time} + \text{Return Time}$ .
- **Manual:** When "Manual" is selected, press the front-panel  key to initiate a sweep output immediately.



#### TIP

When "Internal" or "Manual" is selected, the generator outputs a TTL-compatible signal with the specified edge via the front-panel **[Sync Out]** connector. Please refer to *Trigger Output Setup*.

## 7.8 Mark Frequency

For frequency sweeps, the sync signal outputs a high level at the beginning of the sweep. If the sync mode is set to "Normal", the sync signal goes low at the end of the sweep. If the sync mode is set to "Mark", the sync signal goes low at the specified marker frequency.

After enabling the Sweep function, click or tap the Channel tab at the bottom to enter the Channel Setup Interface. Click or tap the **Sync Mode** drop-down button to set the sync mode of the sweep waveform to "Mark" to enable the function. You can click or tap the **Mark Freq** to set the mark frequency. Mark frequency is limited by the sweep "Start Frequency" and "Stop Frequency".



#### NOTE

For step sweep (the sweep points determined by the start frequency, stop frequency, and step number respectively are  $f_1, f_2, \dots, f_n, f_{n+1}, \dots$ ), if the mark frequency setting is one of the sweep point values, the sync signal is a TTL high level at the beginning of the sweep and a low level at the mark frequency. If the mark frequency is not equal to any of the sweep point values, the sync signal becomes a low level at the sweep point which is less than and closest to the mark frequency when sweeping from high frequency to low frequency or at the sweep point which is greater than and closest to the mark frequency when sweeping from low frequency to high frequency. Take sweeping from high frequency to low frequency as an example. If the mark frequency is set to 1 MHz and the sweep points are 0.99 MHz and 1.01 MHz, then 0.99 MHz will be selected as the mark frequency to be applied to the digital system.

## 8 Burst

DG5000 Pro can output a waveform for a specified number of cycles, called a burst. You can use Sine, Square, Ramp, Pulse, Arb, and Noise (only available for "Gated" Burst) to generate burst waveforms.

Click or tap the "Output Mode" drop-down button to select "Burst" to enter the Burst Setting Interface, as shown in the figure below. You can click or tap one of the tabs at the bottom to enter the Continuous Setting Interface, Burst Setting Interface, or Channel Setup Interface. For Continuous Setting Interface and Channel Setup Interface, please refer to *Continuous* and *Channel Setup* respectively. This chapter only describes the burst settings.



### TIP

The Burst mode cannot be enabled when the fundamental frequency is less than or equal to 125  $\mu$ Hz.

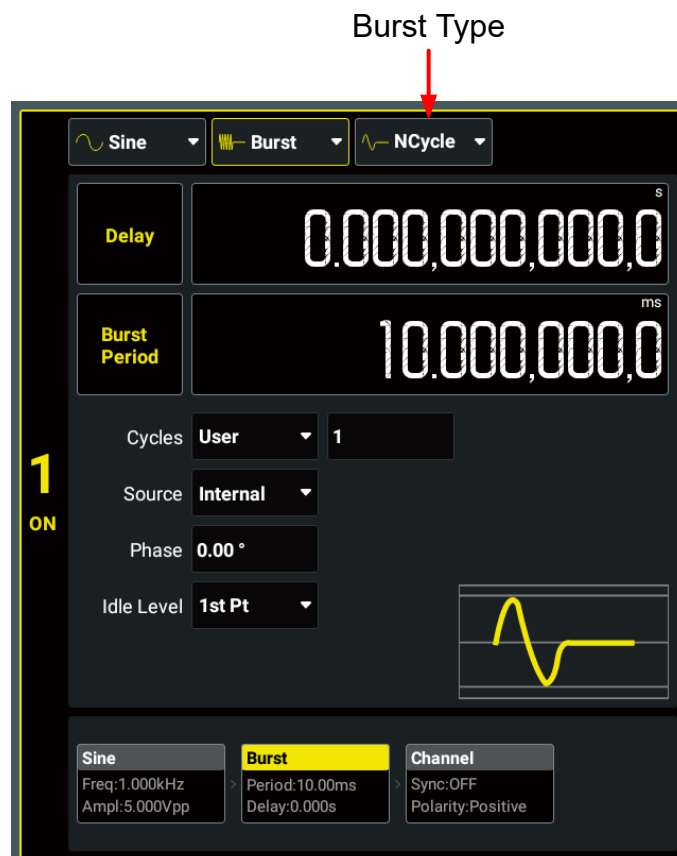

Figure 8.1 Burst Setting Interface

The following table shows the range of the frequency for different carriers in the Burst mode.

Table 8.1 Carrier Frequency Range (Burst Mode)

| Waveform | DG5252 Pro/<br>DG5254 Pro/<br>DG5258 Pro | DG5352 Pro/<br>DG5354 Pro/<br>DG5358 Pro | DG5502 Pro/<br>DG5504 Pro/<br>DG5508 Pro |
|----------|------------------------------------------|------------------------------------------|------------------------------------------|
| Sine     | 1 $\mu$ Hz to 250 MHz                    | 1 $\mu$ Hz to 350 MHz                    | 1 $\mu$ Hz to 350 MHz                    |
| Square   | 1 $\mu$ Hz to 120 MHz                    | 1 $\mu$ Hz to 120 MHz                    | 1 $\mu$ Hz to 120 MHz                    |
| Ramp     | 1 $\mu$ Hz to 2.5 MHz                    | 1 $\mu$ Hz to 2.5 MHz                    | 1 $\mu$ Hz to 2.5 MHz                    |
| Pulse    | 1 $\mu$ Hz to 120 MHz                    | 1 $\mu$ Hz to 120 MHz                    | 1 $\mu$ Hz to 120 MHz                    |
| Arb      | 1 $\mu$ Hz to 100 MHz                    | 1 $\mu$ Hz to 100 MHz                    | 1 $\mu$ Hz to 100 MHz                    |

## 8.1 Burst Type

DG5000 Pro can output two types of bursts: N-Cycle Burst (default) and Gated Burst. In the Burst Setting Interface (*Figure 8.1*), click or tap the "Burst Type" drop-down button to select "N-Cycle" or "Gated". The table below illustrates the trigger sources and waveform parameters available for the two burst types.

| Burst Type    |              | Trigger Source                   | Burst Parameters                                                                                                                |
|---------------|--------------|----------------------------------|---------------------------------------------------------------------------------------------------------------------------------|
| N-Cycle Burst | User-defined | Internal/External/Manual Trigger | Delay, Burst Period, Source, Trigger Output (only available for manual trigger and internal trigger), Phase, Cycles, Idle Level |
|               | Infinite     | External/Manual Trigger          | Delay, Source, Trigger Output (only available for manual trigger), Phase, Cycles, Idle Level                                    |
| Gated Burst   |              | External Trigger                 | Starting Phase, Polarity, Idle Level                                                                                            |

### N-Cycle Burst

In N-Cycle Burst mode, the instrument outputs a waveform for a specified number of cycles (burst count) each time trigger is received. You can also set the burst count to "Infinite". Available waveform functions for N-Cycle burst include Sine, Square, Ramp, Pulse, and Arb. Click or tap the **Cycles** drop-down button to set the burst count.

- **Infinite:** Infinite Burst sets the burst count to "infinite". The instrument outputs a continuous waveform when a trigger signal is received.
- **User:** Click or tap the **Cycles** input field and use the pop-up numeric keypad to set the burst count. It ranges from 1 (default) to 1 M. If you change the burst count, the instrument automatically increases the burst period to accommodate the burst count (but the waveform frequency will not be changed). When the



trigger source is set to internal trigger, the maximum burst count that can be set is affected by the signal frequency.

### Gated Burst

In Gated Burst mode, the generator controls the waveform output based on the external signal level from the rear-panel **[AUX IN]** connector. Available waveform functions for Gated burst include Sine, Square, Ramp, Pulse, Noise, and Arb. When the gate signal is "true", the instrument outputs a continuous waveform. When the gate signal is "false", the instrument first stops the current waveform output and remains at the voltage level corresponding to the "Idle Level" setting.

## 8.2 Burst Delay

Burst delay, which is only available for N-Cycle Burst mode, is the duration from the time when the instrument receives the trigger signal to the time when it starts to output the burst signal.

Click or tap the **Delay** input field and use the pop-up numeric keypad to set the delay. The default delay is 0 s and the resolution is 0.1 ns. The range of burst delay is related to the trigger source:

- Manual/external trigger: 0 s to 85 s.
- Internal trigger: 0 s to  $(T_{burst} - \lceil T_{wave} \times N_{cycle} \div 6.4 \text{ ns} \rceil \times 6.4 \text{ ns} - 4 \mu\text{s})^{[1]}$ , and less than or equal to 85 s.
  - $T_{burst}$ : burst period
  - $T_{wave}$ : period of basic waveform (e.g. Sine and Square)
  - $N_{cycle}$ : burst count

### NOTE

[1]:  $\lceil x \rceil$  indicates that x is rounded up.



## 8.3 Burst Phase

In Burst mode, the phase of the basic waveform is no longer in effect. The phase characteristics are determined by the burst phase. When the burst type is set to "Ncycle", click or tap the **Phase** input field to set the burst phase. When the burst type is set to "Gated", click or tap the **Start Phase** input field to set the phase. It ranges from  $-360^\circ$  to  $360^\circ$ , and the default is  $0^\circ$ . The resolution is  $0.01^\circ$ .

- For Sine, Square, Pulse, and Ramp,  $0^\circ$  is the point at which the waveform crosses 0 V (or DC offset) in a positive-going direction.

- Burst phase setting is not available for noise.
- For arbitrary waveforms, 0° is the first waveform point.

**TIP**

In Burst mode, the phase of the basic waveform is fixed to 0° and cannot be modified.

## 8.4 Burst Period

Burst period is only available for internally triggered N-Cycle burst mode (user-defined burst count). Burst period is defined as the time from the start of a burst to the time when the next burst starts.

Click or tap the **Burst Period** input field and use the pop-up numeric keypad to set the period. It ranges from 4 μs to 8 ks and the default is 10 ms. The resolution is 0.1 ns.

- $\text{Burst Period} \geq \lceil (\text{Burst Count} \times \text{Waveform Period}) \div 6.4 \text{ ns} \rceil \times 6.4 \text{ ns} + 4 \mu\text{s}^{[1]}$
- If the burst period is too short, the generator will increase it automatically to allow the output of the specified number of cycles.

**NOTE**

[1]: [x] indicates that x is rounded up.

## 8.5 Burst Trigger Source

Available trigger sources for bursts include internal trigger, external leading edge, external trailing edge, and manual trigger. Click or tap the **Source** drop-down button and select the trigger source. The default is "Internal".

- **Internal:** Internal trigger is only available for N-Cycle Burst with user-defined burst count. When internal trigger is selected, the instrument outputs a burst of the specified cycles. The rate at which the burst is generated is determined by *Burst Period*. After completing the specified number of cycles, the instrument outputs the idle level and waits for the next trigger event.
- **Ext Leading:** When external leading edge is selected, the instrument receives the trigger signal from the rear-panel **[AUX IN]** connector. A burst is generated each time a TTL pulse with leading edge is received.
- **Ext Trailing:** When external trailing edge is selected, the instrument receives the trigger signal from the rear-panel **[AUX IN]** connector. A burst is generated each time a TTL pulse with trailing edge is received.

- **Manual:** Manual trigger is only available for N-Cycle Burst mode. When manual trigger is selected, press the front-panel **Trigger** key to initiate a burst output immediately. If the output of the corresponding channel is not enabled, the trigger will be ignored.

**TIP**

When "Internal" or "Manual" is selected, the generator outputs a TTL-compatible signal with the specified edge via the front-panel **[Sync Out]** connector. Please refer to *Trigger Output Setup*.

## 8.6 Gated Polarity

Gated polarity is only available for Gated Burst mode. It enables the instrument to output burst signals at a high level or low level. The gate signal is applied to the rear-panel **[AUX IN]** connector.

In the Burst Setting Interface, click or tap the "Burst Type" drop-down button to select "Gated" and enter the Gated Burst Setting Interface. Click or tap the **Polarity** drop-down button to select "Positive" or "Negative". The default is "Positive".

- **Positive:** When the gate signal is a high level, the instrument outputs a continuous waveform. When the gate signal is a low level, the instrument first stops the waveform output of the current period and remains at the voltage level set in the "Idle Level".
- **Negative:** When the gate signal is a low level, the instrument outputs a continuous waveform. When the gate signal is a high level, the instrument stops the current output and remains at the voltage level set in the "Idle Level".

## 8.7 Idle Level

In Burst mode, the output will not be turned off when there is no burst output but will remain at a specified voltage level, which is called the idle level. In N-Cycle Burst mode, the generator outputs a carrier waveform with a specified number of cycles and then continues to output the idle level until a burst period is complete, as shown in the figure below. In Gated Burst mode, the instrument will output the idle level when the gate signal is "false".

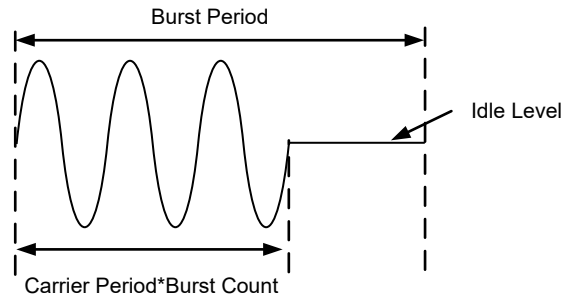

After enabling the Burst function, in Burst Setting Interface, click or tap the **Idle Level** drop-down button to select the idle level.

- **1st Pt:** Select the level at the first point of the carrier waveform as the idle level. It is not available for Square and Pulse.
- **Top:** Select the level at the top of the carrier waveform as the idle level.
- **Center:** Select the level at the center of the carrier waveform as the idle level.
- **Bottom:** Select the level at the bottom of the carrier waveform as the idle level.
- **User:** Select the specified position as the idle level. When "User" is selected, click or tap the **Idle Level** input field and use the pop-up numeric keypad to set the idle level. It ranges from 0 to 65,535, and the default is 0.



#### TIP

When the noise is the carrier waveform, the idle level is fixed to 32768 and cannot be modified.

## 9 Advanced Mode

DG5000 Pro provides seven advanced waveform output types: Arb, Sequence (optional), PRBS, Multi-pulse (optional), Multi-tone (optional), Pattern (optional), and IQ (optional).

Click or tap the "Output Mode" drop-down button to select "Advanced" and access the Advanced Waveform Setting Interface, as shown in the figure below. You can click or tap one of the tabs at the bottom to access the Advanced Waveform Setting Interface or Channel Setup Interface. For Channel Setup Interface, please refer to [Channel Setup](#). This chapter only describes the advanced waveform settings.

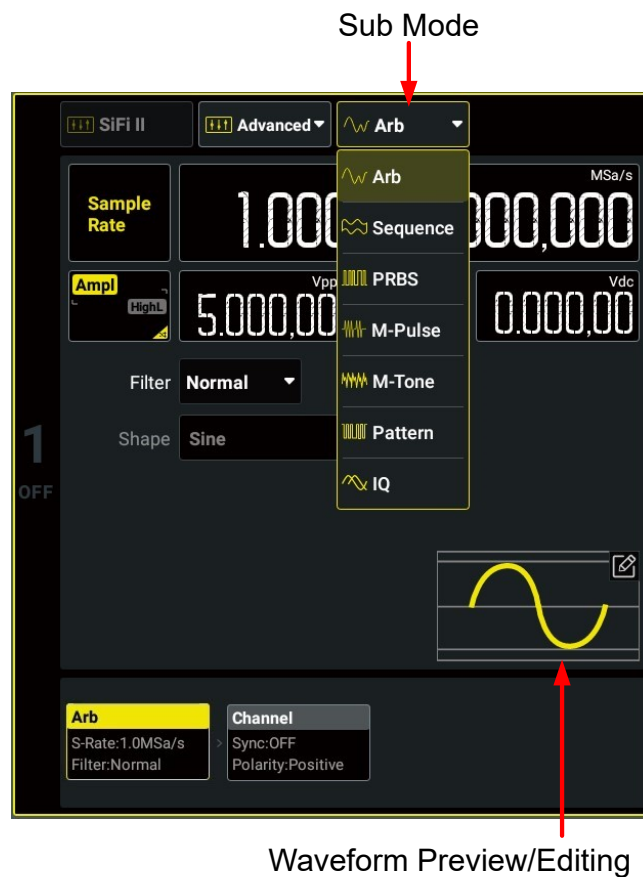

Figure 9.1 Advanced Waveform Setting Interface

### 9.1 Arb

DG5000 Pro supports Arb output in both Continuous mode and Advanced mode. Based on the SiFi technology, DG5000 Pro can output the arbitrary waveforms point by point according to the specified sample rate without losing any important points in the Advanced mode. For the Arb output in the Continuous Mode, refer to [To Output Arbitrary Waveforms](#).

In the Advanced Waveform Setting Interface, click or tap the "Sub Mode" drop-down button to select "Arb" to enter the Arb Setting Interface in the Advanced mode, as shown in the figure below.

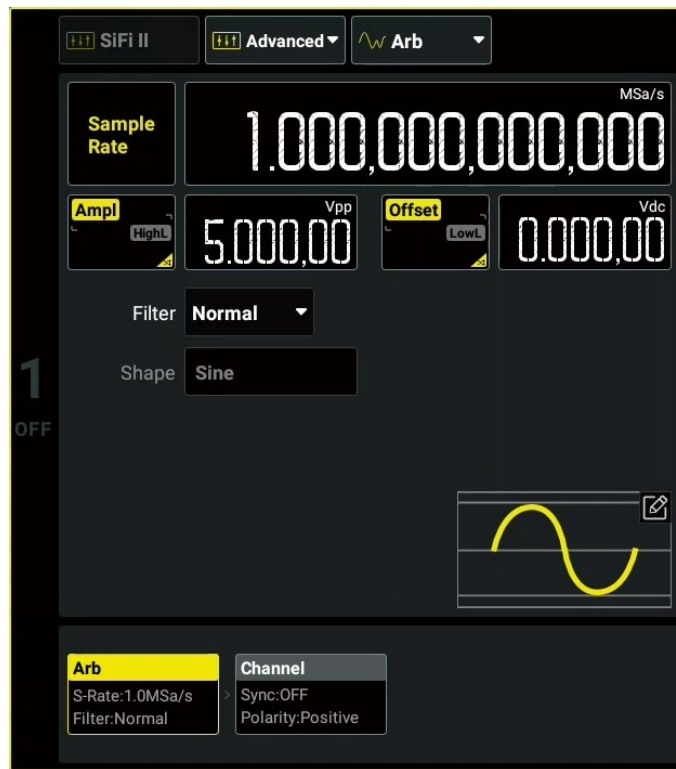

Figure 9.2 Arb Setting Interface (Advanced Mode)

### Select the Data Source

In the Arb Setting Interface, click or tap the "Waveform Preview/Editing" area and select **Built In Wforms** or **Stored Wforms** in the displayed menu.

- Built-in waveforms: stored in the instrument's internal non-volatile memory, containing 11 types of waveforms: **Basic**, **Common**, **Engine**, **Seg Mod**, **Bioelect**, **Medical**, **Standard**, **Maths**, **Trigonome**, **Anti Trigonome**, and **Window Function**. Basic waveforms includes Sine, Square, Ramp, and Noise. For details about other built-in waveforms, refer to [Table 5.4 Built-in Waveforms](#)
- Stored waveforms: Arb files (\*.arb/\*.csv/\*.txt) stored in the instrument's internal memory (C disk) or in the external memory (D disk). After "Stored Wforms" is selected, select the Arb file that you want to load and then click or tap **Load**. After loading, the data in the current volatile memory space will change. You can use the instrument's built-in Arb Build function or use the PC software to edit the Arb waveforms and download them to the instrument.

### NOTE

- When built-in waveforms are selected, the waveform length is fixed to 16,384 pts. When stored waveforms are selected, the available Arb length is related to the file type. For



\*.arb files, the available length is from 32 pts to 64 Mpts (128 Mpts optional). For \*.txt files, the available length is from 32 pts to 8 Mpts. For \*.csv files, the available length is from 32 pts to 1 Mpts.

- DG5000 Pro does not support loading Arb files with file headers. It is recommended to use Ultra Station 00.02.01.00.01 or later to generate Arb waveforms and untick the "Save File With Header" box when saving the file.

### Set the Filter Mode

Click or tap the **Filter** drop-down button to select the filter mode.

- **Normal:** It has wide and flat frequency response as well as short edge time, but the step response produces a large overshoot.
- **Step:** It has more ideal step response, narrow bandwidth, longer rise/fall time, and longer edge time.
- **Edge:** It allows you to define the edge time to create bursts with arbitrary edge time. When "Edge" is selected, you can click or tap the **Filter** input field to set the edge time. When the sample rate is less than 400 MSa/s, the range is from 2 ns to  $0.8 \cdot (1/\text{Sample Rate})$ , and not greater than 1  $\mu$ s. When the sample rate is greater than or equal to 400 MSa/s, it is fixed to  $0.8 \cdot (1/\text{Sample Rate})$ . The resolution of the edge time is 100 ps.
- **Interpolation:** It guarantees the output of signals with no distortion at all.

### Set the Waveform Parameters

Click or tap the **Sample Rate** input field to set the sample rate for the Arb waveform. The available range is from 1  $\mu$ Sa/s to 1.25 GSa/s. The output frequency is automatically calculated according to the number of waveform points: Output Frequency = Sample Rate/Waveform Points.

For other waveform parameters, refer to *Continuous*.

## 9.2 Sequence (Optional)

A sequence is a combination of multiple individual waveforms in order. In Sequence mode, you can self-define the sequence and save the edited sequence to internal memory or external storage device (\*.seq format).

In the Advanced Waveform Setting Interface, click or tap the "Sub Mode" drop-down button to select "Sequence" to enter the Sequence Setting Interface, as shown in the figure below.

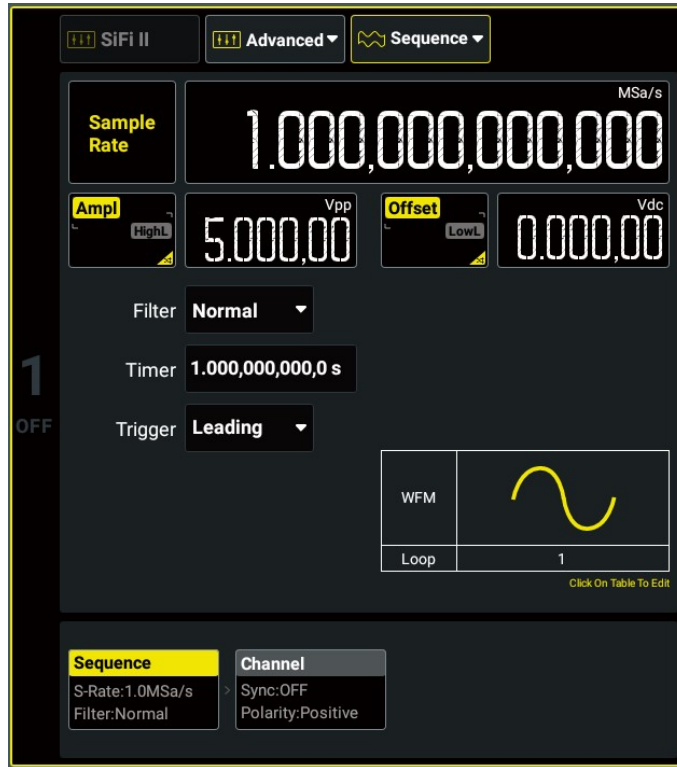

Figure 9.3 Sequence Setting Interface

### 9.2.1 New Sequence

In the sequence editing interface as shown in *Figure 9.3*, click or tap the "Waveform Preview/Editing" area to open the sequence editing table, as shown in the figure below.

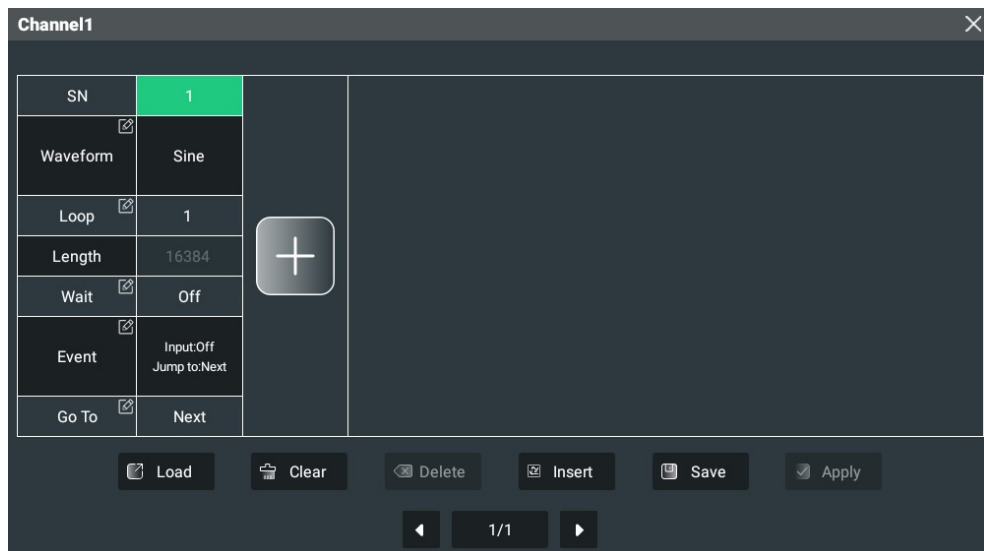





Figure 9.4 Sequence Editing Table



After the sequence editing table is enabled, it contains a step of sine wave with the loop of 1 by default. You can use the procedure below to add new steps and edit step properties for the sequence.

1. Click or tap  to add a new step at the end of the sequence. You can also select the SN of any step from the **SN** row and then click or tap **Insert** to add a step before the selected step. A sequence supports a maximum of 512 steps.

#### TIP

If there are too many steps for the screen to display, you can slide the table left and right or use the   at the bottom to view other steps.

2. Click or tap the cell in the **Waveform** row to select the waveform type for the specified step in the pop-up menu. You can select built-in waveforms or stored waveforms (\*.arb/\*.csv/\*.txt).

#### NOTE

For descriptions of the three Arb file formats, refer to *To Output Arbitrary Waveforms*.



3. Click or tap the cell in the **Loop** row to set the number of cycles with the pop-up numeric keypad for the specified step. The maximum value is 256.
4. Refer to *Output Rules* to set the **Wait**, **Event**, and **Go To** for the step.
5. After the editing, click or tap **Apply** to confirm the modification and load the sequence waveform to the current channel.

If you want to clear all the step configurations, click or tap **Clear** and the table will be restored to its default state. If you want to delete the specified step, click or tap its SN and then click or tap **Delete** to delete the selected step.

#### TIP

- When the wave type of the step is set to a built-in waveform, the wave length is fixed to 16384 and cannot be modified. When the waveform type of the step is set to self-defined Arb, the available Arb length is related to the file type. For \*.arb files, the available length is from 32 pts to 64 Mpts (128 Mpts optional). For \*.txt files, the available length is from 32 pts to 8 Mpts. For \*.csv files, the available length is from 32 pts to 1 Mpts.
- The total points of the steps in the current sequence cannot exceed 64 Mpts (128 Mpts optional).
- When using the sequence function, if the sample rate of the sequence exceeds 800 MSa/s, it is recommended that the waveform length of each step be no less than 200 pts; if it is necessary to perform non-sequential jumps among multiple steps (that is, the steps are executed non-sequentially through "Go to" and "Jump to"), it is recommended that the waveform length of each step be no less than 4000 pts. Insufficient step length may cause waveform disorder or unexpected clutter.



## 9.2.2 Output Rules

The sequence editing table displays the output rules of each step in the current sequence, as shown in the figure below. By default, the waveform starts to play sequentially by the SN without a trigger signal.

DG5000 Pro allows you to modify the output rules of any step in a sequence as required. You can define the conditions (Wait, Event, and Go To) to play the specified step in the sequence using the sequence editing table as shown in the figure below.

| SN                                                                                         | 1                         | 2                         | 3                         | 4                         | 5                         | 6                         |
|--------------------------------------------------------------------------------------------|---------------------------|---------------------------|---------------------------|---------------------------|---------------------------|---------------------------|
| Waveform  | Sine                      | Sine                      | Sine                      | Sine                      | Sine                      | Sine                      |
| Loop      | 1                         | 1                         | 1                         | 1                         | 1                         | 1                         |
| Length                                                                                     | 16384                     | 16384                     | 16384                     | 16384                     | 16384                     | 16384                     |
| Wait      | Off                       | Off                       | Off                       | Off                       | Off                       | Off                       |
| Event     | Input:Off<br>Jump to:Next | Input:Off<br>Jump to:Next | Input:Off<br>Jump to:Next | Input:Off<br>Jump to:Next | Input:Off<br>Jump to:Next | Input:Off<br>Jump to:Next |
| Go To     | Next                      | Next                      | Next                      | Next                      | Next                      | Next                      |

### Wait

"Wait" is used to set the conditions required for the step to start playing the cycle, including whether to wait for a trigger signal and the type of the trigger signal. In the sequence editing table, click or tap the cell in the **Wait** row of the specified step and select the wait event from the drop-down menu.

- Off: no waiting. The step plays immediately without waiting for trigger. The default setting is Off.
- Ext: waiting for trigger. The step does not start playing the waveform until an external trigger signal with a specified edge is received. You can click or tap the **Trigger** drop-down button to select the edge type of the external trigger signal in the Sequence Setting Interface (see *To Set Sequence Parameters*).
- Manual: waiting for trigger. The step does not start playing the waveform until a manual trigger signal is received.
- Timer: waiting for trigger. The step does not start playing the waveform until a trigger signal generated by the instrument's internal clock is received. You can click or tap the **Timer** input field to set the interval of the internally triggered signals in the Sequence Setting Interface (see *To Set Sequence Parameters*).

### NOTE

One cycle of the step is output each time a valid trigger signal is received.



## Event

You can set the event input and event jump to for each step. In the sequence editing table, click or tap the cell in the **Event** row of the step and the "Event" menu as shown in the figure below will be displayed.

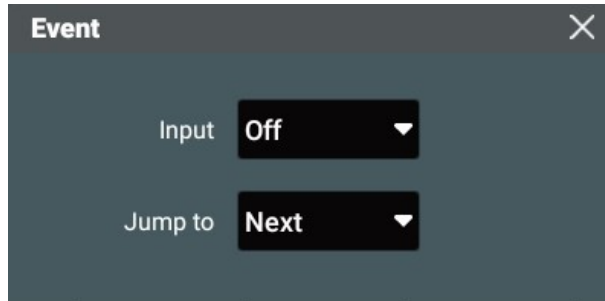

Event "Input" defines whether an event jump will occur and the type of trigger signal that will cause a jump to occur. Click or tap the **Input** drop-down button to set the event jump.

- Off: An event jump is not active for the step. The sequence uses the Go To definition after finishing this step. The default setting is "Off".
- Ext: An event jump occurs when an external trigger signal with the specified edge is received during the playout of the current step. You can click or tap the **Trigger** drop-down button to select the edge type of the external trigger signal in the Sequence Setting Interface (see [To Set Sequence Parameters](#)).
- Manual: An event jump occurs when a manual trigger signal is received during the playout of the current step.
- Timer: An event jump occurs when a trigger signal generated by the instrument's internal clock is received during the playout of the current step. You can click or tap the **Timer** input field to set the interval of the internally triggered signals in the Sequence Setting Interface (see [To Set Sequence Parameters](#)).

If the event input is not set to "Off", when the specified trigger signal is received, the sequence first completes playing the current waveform cycle and then jump to the specified destination immediately, regardless of whether the current step executes the total number of cycles. Click or tap the **Jump to** drop-down button to select the "Next", "First", or "Last" step to jump to. You can also select "Specify SN" and input the step SN with the numeric keypad.

## Go To

Go To jump is used to set the target step in the sequence to jump to and play after the current step executes the total number of complete waveform cycles. In the sequence editing table, click or tap the cell in the **Go To** row of the step to set the step to go to.

- Next: The sequence goes to the next step after the current step has finished playing its waveform. It is the default setting. If "Next" is chosen for the last step

in the sequence, the sequence goes to the first step and play after the last step finishes its playout.

- **First:** The sequence goes to the first step after the current step has finished playing its waveform.
- **Last:** The sequence goes to the last step after the current step has finished playing its waveform.
- **End:** The sequence ends when finished with the current step.
- **Specify SN:** You can also specify the SN of the target step with the numeric keypad. The sequence goes to the specified step after the current step has finished playing its waveform.

### 9.2.3 To Save/Load Sequence

#### Save Sequence

After editing a sequence, you can save the sequence to the internal memory or external storage device.

1. In the interface as shown in *Figure 9.4*, click or tap **Save** and the "Store" menu is displayed.
2. Enter the target path in the internal/external memory. Click or tap **Save** and the virtual keypad is displayed.
3. Set the sequence name with the pop-up virtual keypad and then click or tap **Enter** to save the sequence. Then you can see the sequence that you saved under the target path.

#### Load Sequence

You can load the sequence files stored in the internal memory or external storage device.

1. In the interface as shown in *Figure 9.4*, click or tap **Load** and the "Store" menu is displayed.
2. Enter the target path in the internal/external memory and tick the sequence file (\*.seq) that you want to load.
3. Click or tap **Load** and the instrument will open the file in the sequence editing table and apply to the current channel.



#### TIP

For general operations of the "Store" menu, please refer to *Storage Management*.

## 9.2.4 To Set Sequence Parameters

In the interface as shown in *Figure 9.3*, you can also set the following parameters.

### Set the Sample Rate

Click or tap the **Sample Rate** input field to set the sample rate for the sequence. The sample rate ranges from 1  $\mu$ Sa/s to 1.25 GSa/s, and the default is 1 MSa/s.

### Set the Amplitude/High Level

Refer to *To Output Sine Wave* to set the amplitude/high level. Note that Vrms and dBm are not available for the unit of the sequence amplitude.

### Set the Offset/Low Level

Refer to *To Output Sine Wave* to set the offset/low level.

### Set the Filter Mode

Click or tap the **Filter** drop-down button to select the filter mode.

- **Normal:** It has wide and flat frequency response as well as short edge time, but the step response produces a large overshoot.
- **Step:** It has more ideal step response, narrow bandwidth, longer rise/fall time, and longer edge time.
- **Edge:** It allows you to define the edge time to create bursts with arbitrary edge time. When "Edge" is selected, you can click or tap the **Filter** input field to set the edge time. When the sample rate is less than 400 MSa/s, the range is from 2 ns to  $0.8 \cdot (1/\text{Sample Rate})$ , and not greater than 1  $\mu$ s. When the sample rate is greater than or equal to 400 MSa/s, it is fixed to  $0.8 \cdot (1/\text{Sample Rate})$ . The resolution of the edge time is 100 ps.
- **Interpolation:** It guarantees the output of signals with no distortion at all.

### Set the External Trigger Mode

Click or tap the **Trigger** drop-down button to select "Leading" or "Trailing".

#### TIP

When the "Wait" or the Event "Input" of the specified step is set to "Ext", to make sure that each input event is responded, the arrival interval of these events should meet the following: Event Input Cycle > Step Output Time. If the event input cycle is less than the threshold, excess events will be ignored.

### Set the Timer

Click or tap the **Timer** input field to set the interval to generate internally triggered signals. The available range is from 4  $\mu$ s to 8000 s.





**TIP**

When the "Wait" or the Event "Input" of the specified step is set to Timer, to make sure that each timer signal is responded, the timer should be greater than the step output time. If the timer is less than the threshold, excess signals will be ignored.

### 9.3 PRBS

Pseudo Random Binary Sequence (PRBS) can be generated using a Linear Feedback Shift Register (LFSR), as shown in the figure below.

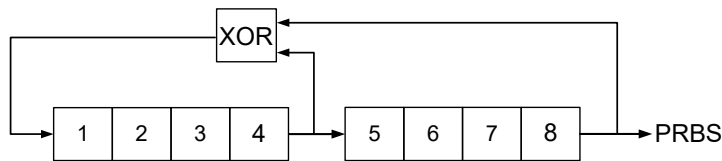

An LFSR is determined by the number of stages (L) it contains and which of those stages ("taps") feed the exclusive-or (XOR) gates in its feedback network. The PRBS output is taken from the last stage. With properly selected taps, an L-stage LFSR generates a repetitive PRBS with the length of  $2^L-1$ . The clock frequency of the LFSR determines the "bit rate" of the PRBS.

PRBS supports PRBS3 to PRBS32. The initial value of PRBS is 0x1, and the corresponding PRBS polynomials are as shown in the table below.

**Table 9.1 PRBS Polynomial Expression**

| PRBS Type | Polynomial Expression | PRBS Type | Polynomial Expression |
|-----------|-----------------------|-----------|-----------------------|
| PRBS3     | $x^3+x+1$             | PRBS18    | $x^{18}+x^5+x^2+x+1$  |
| PRBS4     | $x^4+x+1$             | PRBS19    | $x^{19}+x^5+x^2+x+1$  |
| PRBS5     | $x^5+x^2+1$           | PRBS20    | $x^{20}+x^3+1$        |
| PRBS6     | $x^6+x+1$             | PRBS21    | $x^{21}+x^2+1$        |
| PRBS7     | $x^7+x^3+1$           | PRBS22    | $x^{22}+x+1$          |
| PRBS8     | $x^8+x^4+x^3+x^2+1$   | PRBS23    | $x^{23}+x^5+1$        |
| PRBS9     | $x^9+x^4+1$           | PRBS24    | $x^{24}+x^4+x^3+x+1$  |
| PRBS10    | $x^{10}+x^3+1$        | PRBS25    | $x^{25}+x^3+1$        |
| PRBS11    | $x^{11}+x^2+1$        | PRBS26    | $x^{26}+x^6+x^2+x+1$  |

| PRBS Type | Polynomial Expression   | PRBS Type | Polynomial Expression  |
|-----------|-------------------------|-----------|------------------------|
| PRBS12    | $x^{12}+x^6+x^4+x+1$    | PRBS27    | $x^{27}+x^5+x^2+x+1$   |
| PRBS13    | $x^{13}+x^4+x^3+x+1$    | PRBS28    | $x^{28}+x^3+1$         |
| PRBS14    | $x^{14}+x^5+x^3+x+1$    | PRBS29    | $x^{29}+x^2+1$         |
| PRBS15    | $x^{15}+x+1$            | PRBS30    | $x^{30}+x^6+x^4+x+1$   |
| PRBS16    | $x^{16}+x^{12}+x^3+x+1$ | PRBS31    | $x^{31}+x^{28}+1$      |
| PRBS17    | $x^{17}+x^3+1$          | PRBS32    | $x^{32}+x^7+x^6+x^2+1$ |

In the Advanced Waveform Setting Interface, click or tap the "Sub Mode" drop-down button to select "PRBS" to enter the PRBS Setting Interface, as shown in the figure below.

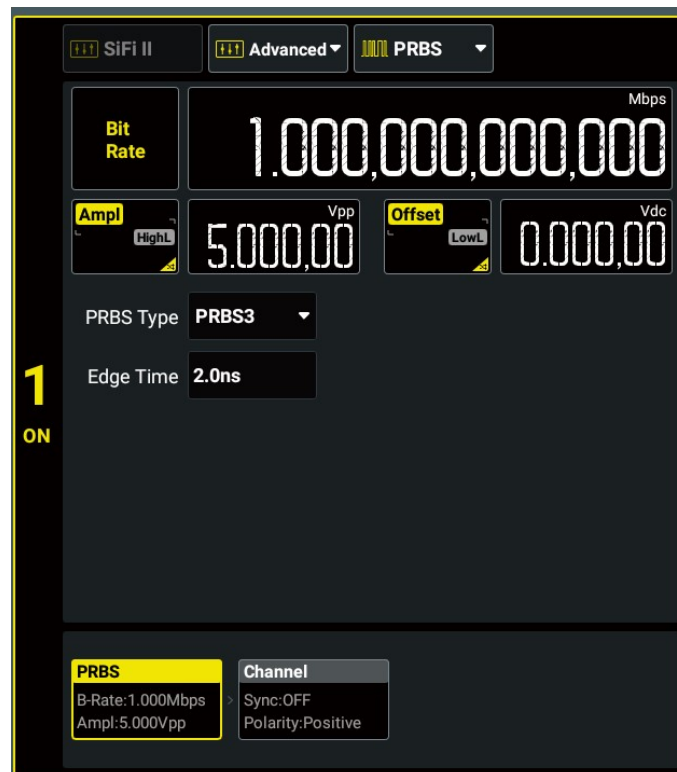

Figure 9.6 PRBS Setting Interface

After entering the PRBS Setting Interface, you can set the following parameters.

#### Set the Bit Rate

Click or tap the **Bit Rate** input field to set the bit rate for PRBS. The available range is from 1  $\mu$ bps to 300 Mbps, and the default is 1 Mbps.

### Set the Amplitude/High Level

Click or tap the **Ampl/HighL** input field to set the amplitude/high level for PRBS. Note that Vrms and dBm are not available for the unit of the PRBS.

### Set the Offset/Low Level

Click or tap the **Offset/LowL** input field to set the offset/low level for PRBS.

### Set the PRBS Type

Click or tap the **PRBS Type** drop-down button to select the data type for PRBS. The available range is from PRBS3 to PRBS32. The length of PRBSn is  $2^n - 1$ .

### Set the Edge Time

Click or tap the **Edge Time** input field to set the duration time of the pulse edge (10% to 90%). The available range is from 2 ns to 1  $\mu$ s. The actual maximum edge time is limited by the current bit rate.

## 9.4 Multi-pulse (Optional)

The Multi-pulse signal is a signal sequence composed of multiple pulses. You can set the number of pulses as well as the width of each pulse for the Multi-pulse waveforms to meet specific test requirements.

In the Advanced Waveform Setting Interface, click or tap the "Sub Mode" drop-down button to select "M-Pulse" to enter the Multi-pulse Setting Interface, as shown in the figure below.



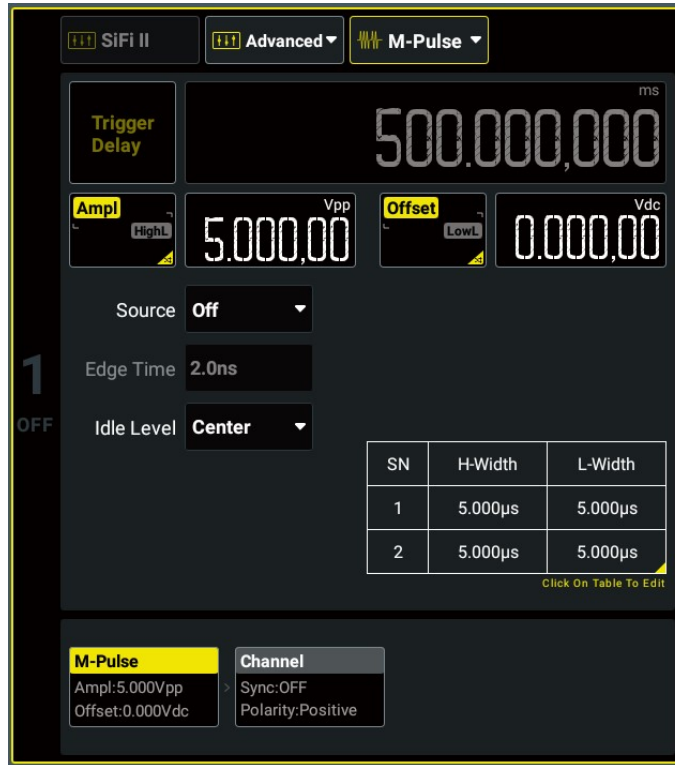

Figure 9.7 Multi-pulse Setting Interface

In the Multi-pulse Setting Interface, click or tap the "Waveform Preview/Editing" area to enter the Multi-pulse Setting Menu, as shown in the figure below. In this menu, you can set the pulse count, edge time, and high/low pulse width for the multi-pulse waveforms. You can click or tap **Apply** to confirm and apply the modifications.

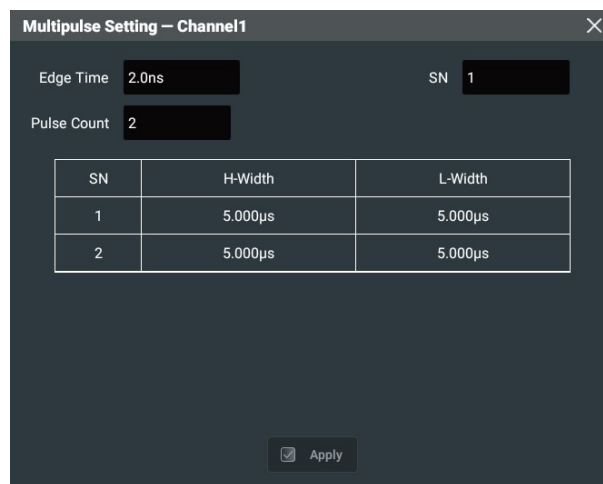

Figure 9.8 Multi-pulse Setting Menu

### Set the Pulse Count

In the Multi-pulse Setting Menu (*Figure 9.8*), click or tap the **Pulse Count** input field to set the number of pulses with the pop-up numeric keypad. The available range is from 2 to 30.

### Set the Pulse High/Low Level Width

In the editing table of the Multi-pulse Setting Menu (*Figure 9.8*), click or tap the cell in the **H-Width/L-Width** column to set the high/low level width for the specified pulse with the pop-up numeric keypad. The available range is from 20 ns to 150  $\mu$ s.

#### TIP

When there are a large number of pulses, you can click or tap the **SN** input field to set the SN of the pulse to locate the specified pulse quickly.

### Set the Edge Time

In the Multi-pulse Setting Menu (*Figure 9.8*), click or tap the **Edge Time** input field to set the edge time for the Multi-pulse waveform. The available range is from 2 ns to 1  $\mu$ s. The actual range is limited by the minimum high/low level width.

### Set the Trigger Source

In the Multi-pulse Setting Interface (*Figure 9.7*), click or tap the **Source** drop-down button to set the trigger source to "Off", "Ext", "Manual", or "Timer".

- Off: The trigger function is disabled. When the channel output is turned on, the multi-pulse waveform can be output without waiting for the trigger signal.
- Ext: The multi-pulse waveform is output when the trigger signal with the specified edge is received via the rear-panel **[AUX IN]** connector. When "Ext" is selected, you can click or tap the **Ext** drop-down button to select "Leading" or "Trailing".
- Manual: The multi-pulse waveform is output when a manual trigger signal is received.
- Timer: The multi-pulse waveform is output when the trigger signal generated by the instrument's internal clock is received. After "Timer" is selected, you can click or tap the input field of **Timer** to set the interval for generating the internally triggered signals. The available range is from 5  $\mu$ s to 8 ks. The actual minimum value is limited by the trigger delay time and the high and low pulse width sum:  

$$\text{Timer} \geq \text{Trigger Delay} + \text{High Pulse Width Sum} + \text{Low Pulse Width Sum}.$$

#### NOTE

When the trigger source is set to "Ext", to make sure that each input event is responded, the arrival interval of these events should meet the following:  $\text{Event Input Cycle} \geq \text{Trigger Delay} + \text{High Pulse Width Sum} + \text{Low Pulse Width Sum}$ . If the event input cycle is less than the threshold, excess events will be ignored.

### Set the Idle Level

In Multi-pulse mode, the output will not be turned off when there is no pulse output but will remain at a specified voltage level, which is called the idle level. In the Multi-

pulse Setting Interface (*Figure 9.7*), click or tap the **Idle Level** drop-down button to select the idle level.

- 1st Pt: sets the level at the first point of the Multi-pulse waveform as the idle level.
- Top: sets the level at the top point of the Multi-pulse waveform as the idle level.
- Center: sets the level at the center point of the Multi-pulse waveform as the idle level.
- Bottom: sets the level at the bottom point of the Multi-pulse waveform as the idle level.

### Set the Trigger Delay

Trigger delay is the duration from the time when the instrument receives the trigger signal to the time when it starts to output the multi-pulse signal. When **Source** is set to "Off", this item is not available. In the Multi-pulse Setting Interface (*Figure 9.7*), click or tap the **Trigger Delay** input field to set the trigger delay with the pop-up numeric keypad. The available range is from 5  $\mu$ s to 1 s.

### Set the Amplitude/High Level

In the Multi-pulse Setting Interface (*Figure 9.7*), click or tap the **Ampl/HighL** input field to set the amplitude/high level for the multi-pulse waveform. Note that Vrms and dBm are not available for the amplitude unit of the Multi-pulse.

### Set the Offset/Low Level

In the Multi-pulse Setting Interface (*Figure 9.7*), click or tap the **Offset/LowL** input field to set the offset/low level for the multi-pulse waveform.

## 9.5 Multi-tone(Optional)

A multi-tone waveform is the superposition of multiple tones (sine) with different frequencies. The on/off, amplitude, and phase of each tone can be set separately. In the frequency domain, the multi-tone signal is represented as multiple discrete frequency components, providing a wealth of spectral information. The multi-tone signals are widely used for test and measurement in audio, communications, and power electronics.

In the Advanced Waveform Setting Interface, click or tap the "Sub Mode" drop-down button to select "M-Tone" to enter the Multi-tone Setting Interface, as shown in the figure below.

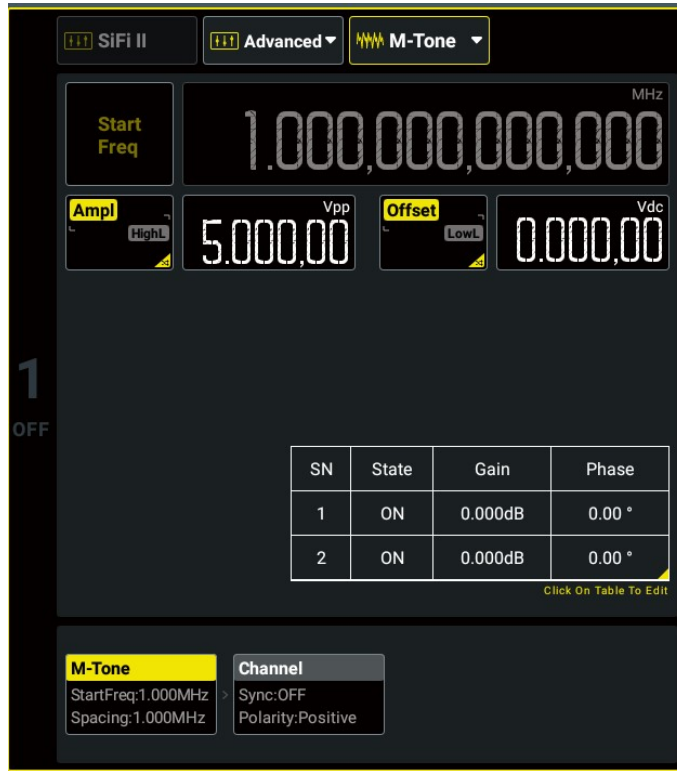

Figure 9.9 Multi-tone Setting Interface

After entering the Multi-tone Setting Interface, you can set the following parameters.

**Set the Tone Parameters**

In the Multi-tone Setting Interface as shown in *Figure 9.9*, click or tap the "Waveform Preview/Editing" area to open the "Multitone Setting" menu, as shown in the figure below.

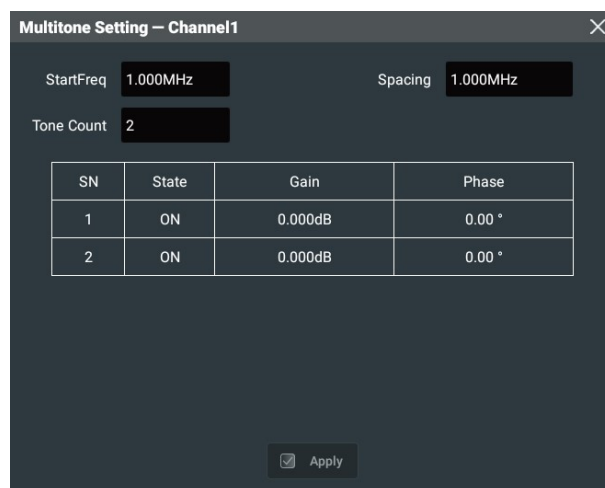

Figure 9.10 Multi-tone Setting Menu

1. Click or tap the **StartFreq** input field to set the start frequency with the pop-up numeric keypad. The available range is from 1 kHz to 499.999 MHz.



#### NOTE

In actual use, the Start Frequency, Spacing, and Tone Count are constrained. Start Frequency + Spacing\*(Tone Count - 1) ≤ 500 MHz. Their values cannot exceed the range.

2. Click or tap the **Spacing** input field to set the frequency spacing between tones with the pop-up numeric keypad. The available range is from 1 kHz to 499.999 MHz.
3. Click or tap the **Tone Count** input field to set the number of tones with the pop-up numeric keypad. The available range is from 2 to 16.
4. Click or tap the cell in the **State** column to turn on or off the specified tone.
5. Click or tap the cell in the **Gain** column to set the gain of the specified tone with the pop-up numeric keypad. The available range is from -20 dB to 0 dB.
6. Click or tap the cell in the **Phase** column to set the phase of the specified tone with the pop-up numeric keypad. The available range is from 0° to 360°.
7. After editing, click or tap **Apply** to confirm the modifications and set the multi-tone waveforms as the waveform of the current channel.

#### Set the Amplitude/High Level

In the Multi-tone Setting Interface (*Figure 9.9*), click or tap the **Ampl/HighL** input field to set the amplitude/high level for the multi-tone waveform. Note that Vrms and dBm are not available for the amplitude unit of the multi-tone waveforms.

#### Set the Offset/Low Level

In the Multi-tone Setting Interface (*Figure 9.9*), click or tap the **Offset/LowL** input field to set the offset/low level for the multi-tone waveform.

## 9.6 Pattern (Optional)

The pattern generator can generate user-defined digital signal sequences used for the debugging and verification of digital circuits and systems.

In the Advanced Waveform Setting Interface, click or tap the "Sub Mode" drop-down button to select "Pattern" to enter the Pattern Setting Interface, as shown in the figure below.

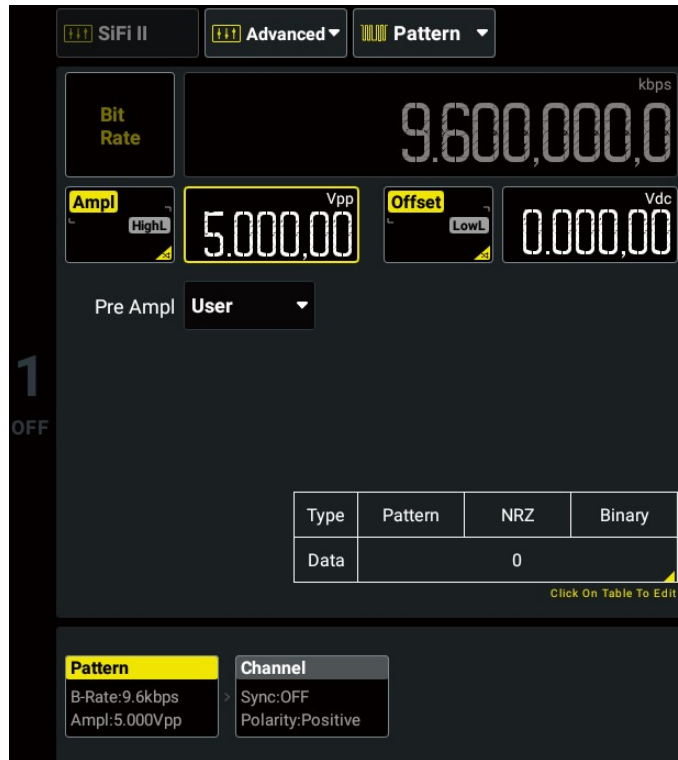

Figure 9.11 Pattern Setting Interface

In the Pattern Setting Interface, click or tap the "Waveform Preview/Editing" area to open the Pattern Setting Menu, as shown in the figure below. In this menu, you can set the bit rate, data type, encoding type, data format, and other parameters for the pattern. You can click or tap **Apply** to confirm and apply the modifications.

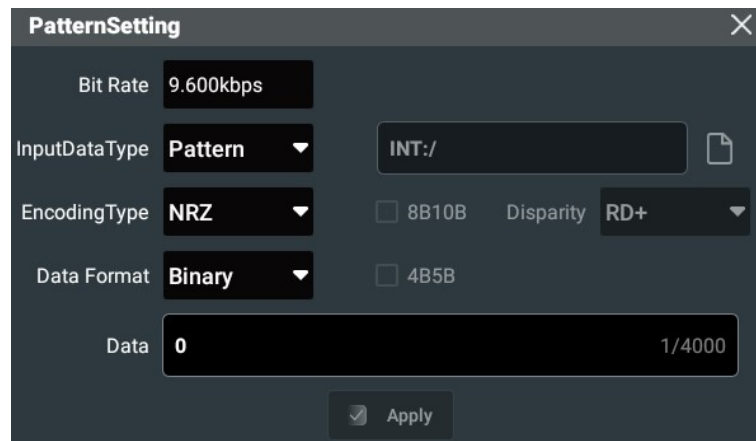

Figure 9.12 Pattern Setting Menu

### Set the Output Amplitude

In the Pattern Setting Interface (Figure 9.11), click or tap the **Ampl/HighL** or **Offset/LowL** input field to self-define the output amplitude. At this point, the **Pre Ampl** item is displayed as "User".

You can also click or tap the **Pre Ampl** drop-down button to select the preset amplitude format for pattern output. After the specified amplitude format is selected, the amplitude-offset (high level-low level) will be automatically modified to the value corresponding to the amplitude format, as shown in the table below.

**Table 9.2 Pattern Preset Amplitude (HighZ)**

| Amplitude Type | Amplitude | Offset   |
|----------------|-----------|----------|
| TTL            | 5.0 Vpp   | 2.5 Vdc  |
| CMOS5.0        | 5.0 Vpp   | 2.5 Vdc  |
| CMOS3.3        | 3.3 Vpp   | 1.65 Vdc |
| CMOS2.5        | 2.5 Vpp   | 1.25 Vdc |
| CMOS1.8        | 1.8 Vpp   | 900 mVdc |
| ECL            | 5.2 Vpp   | -2.6 Vdc |
| PECL           | 800 mVpp  | 2.0 Vdc  |

### Set the Bit Rate

In the Pattern Setting Menu (*Figure 9.12*), click or tap the **Bit Rate** input field to set the bit rate with the pop-up numeric keypad. The available range is from 1  $\mu$ bps to 300 Mbps, and the default value is 9.6 kbps. The bit rate will be displayed in the **Bit Rate** item in the *Figure 9.11* interface.

### Set the Input Data Type

In the Pattern Setting Menu (*Figure 9.12*), click or tap the **InputDataType** drop-down button to set the data type to "Pattern" or "File".

- Pattern: set the input data type to self-defined symbol. When "Pattern" is selected, you can click or tap the Data input field to define the data with the pop-up numeric keypad. The maximum length is 4000 characters for binary and 1000 characters for hexadecimal and KD symbol.
- File: import user-defined codes via the internal memory/external USB storage device. When "File" is selected, you can click or tap the file path input field or  to select the target file in the displayed storage menu and then click or tap **Load**. After the file is successfully loaded, the data type of the imported file is displayed in the import icon: B (binary), H (hexadecimal), S (KD symbol).

The maximum data length of the imported file is related to the data format of the file. The data length is limited to 64M characters for binary and 12M characters for hexadecimal and KD symbol.

**NOTE**

DG5000 Pro only supports files of \*.txt format. The data in the binary code file should start with b, for example, b1100101010. The data in the hexadecimal file should start with h, for example, h123ABE5. The data in the KD symbol file should start with s and be separated by comma, for example, sD1.3,D2.3.

**Set the Encoding Type**

In the Pattern Setting Menu (*Figure 9.12*), click or tap the **EncodingType** drop-down button to select "NRZ", "RZ", or "Manchester".

- NRZ: Non-Return-to-Zero
- RZ: Unipolar Return-to-Zero
- Manchester: Manchester encoding. Transition from low to high in the middle of bit period represents "0"; transition from high to low in the middle of bit period represents "1".

**Set the Data Format**

When the input data type is set to "Pattern", you can click or tap the **Data Format** drop-down button to set the pattern type to "Binary", "Hex", or "Symbol".

**Input the Data**

When the input data type is set to "Pattern", you can click or tap the "Data" input field to set the data with the pop-up numeric keypad.

When the data format is set to "Binary", you can only use "0", "1", "CE", "Back", and "Enter" keys while other keys are disabled. When the data format is set to "Hex", you can use "0-9", "A-F", "CE", "Back", and "Enter" keys while other keys are disabled.

When the data format is set to "Symbol", you can use "0-9", "K", "D", ".", ",", "CE", "Back", and "Enter" keys while other keys are disabled.

**8B10B Encoding**

8B10B encoding is used to encode a byte (8-bit data) to 10-bit data. It is available only when the data format of the input pattern or the imported file is set to "Symbol". Otherwise, it is grayed out. After the 8B10B encoding function is enabled, you can set the polarity of the 8B10B encoding. Disparity is the difference between the number of 1 bits and 0 bits of the first code value after encoding. Available options include RD+ (more 0 bits than 1 bits or equal number of 1 bits and 0 bits) and RD- (more 1 bits than 0 bits or equal number of 1 bits and 0 bits).

**4B5B Encoding**

4B5B encoding is used to encode 4 bits of data to a 5-bit code. It is available only when the data format of the input pattern or the imported file is set to "Hex". Otherwise, it is grayed out.



## 9.7 IQ Waveform (Optional)

In IQ Modulation, the input data is mapped to the corresponding in-phase (I) and quadrature (Q) components through the specified mapping rule (modulation). The two components are then modulated by the carrier to obtain  $s(t)$  signal. The block diagram of IQ modulation is as shown in the figure below.

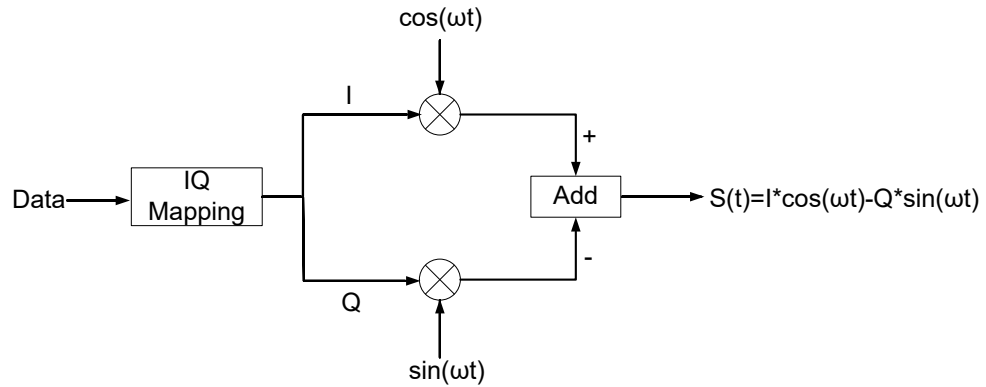

Figure 9.13 Block Diagram of IQ Modulation

In the Advanced Waveform Setting Interface, click or tap the "Sub Mode" drop-down button to select "IQ" to enter the IQ Setting Interface, as shown in the figure below.

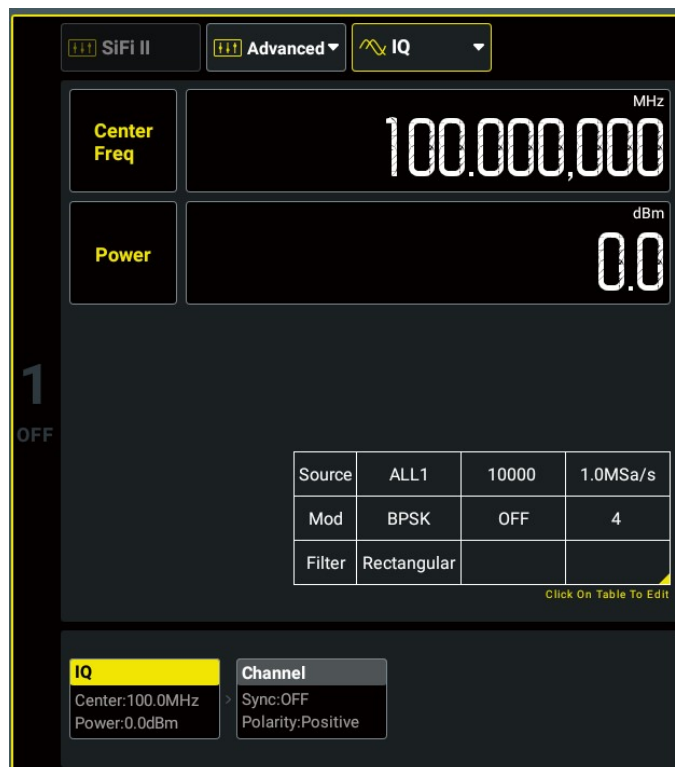
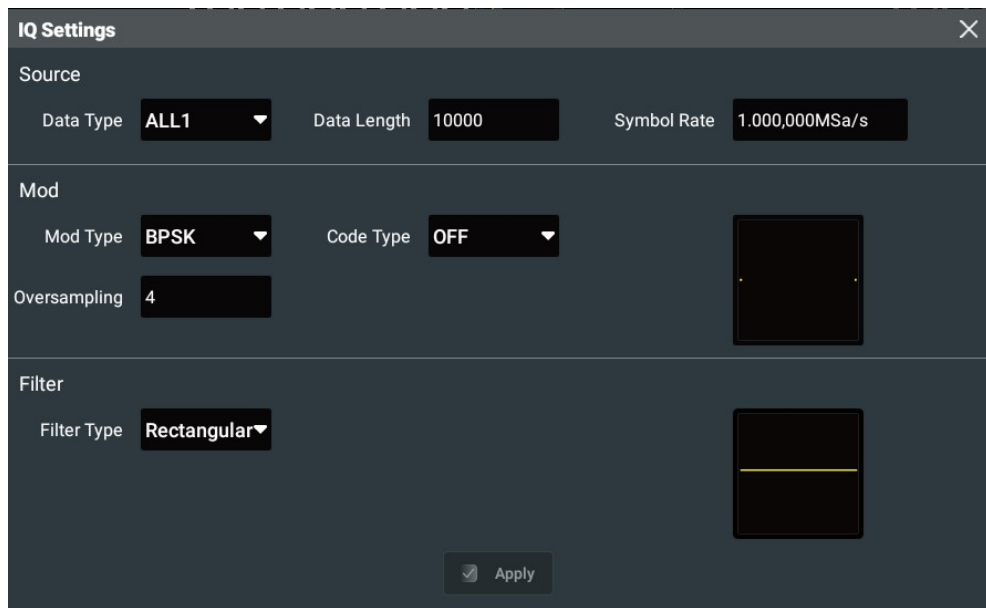

Figure 9.14 IQ Setting Interface

**TIP**

- IQ modulation requires resources from two channels, therefore only channels of odd numbers (n=1, 3, 5, 7) are allowed to enable IQ modulation. When IQ modulation is enabled for channel n, channel n+1 will be disabled.
- In IQ mode, the output impedance (*Output Impedance*) is fixed to 50  $\Omega$  and cannot be modified.

In the IQ Setting Interface, click or tap the "Waveform Preview/Configuration" area to open the IQ Setting Menu, as shown in the figure below. In this menu, you can set the data source, modulation parameters, and the filter type for the IQ waveform. Click or tap **Apply** to confirm and apply the modifications.



**Figure 9.15 IQ Setting Menu**

**Set the Data Type**

In the IQ Setting Menu (*Figure 9.15*), click or tap the **Data Type** drop-down button to select the data type for the IQ waveform.

- ALL1: set the data type to a sequence in which all bits are 1.
- ALL0: set the data type to a sequence in which all bits are 0.
- PRBSn: set the data type to PRBS9, PRBS11, PRBS15, PRBS16, PRBS20, PRBS21, or PRBS23. The initial value of PRBS is 0x1. For the corresponding PRBS polynomial, please refer to *Table 9.1 PRBS Polynomial Expression*.

**Set the Data Length**

In the IQ Setting Menu (*Figure 9.15*), click or tap the **Data Length** input field to set the data length with the pop-up numeric keypad. The available range is from 10 to 20M, and the default is 10k. When the data length does not match the modulation

scheme, the system automatically adjusts the data length. To ensure the integrity of the input data, it is recommended to match the input data length with the selected modulation scheme. For example, it is recommended to set the data length of 8PSK (symbol length= $\log_2 8=3$ ) to an integer multiple of 3 and the length of 256QAM (symbol length= $\log_2 256=8$ ) to an integer multiple of 8.

### Set the Symbol Rate

Symbol rate refers to the number of symbols transmitted per second. In the IQ Setting Menu (*Figure 9.15*), click or tap the **SymbolRate** input field to set the symbol rate with the pop-up numeric keypad. The available range is from 100 Sa/s to 100 MSa/s, and the default is 1 MSa/s.

### Set the Modulation Type

In the IQ Setting Menu (*Figure 9.15*), click or tap the **Mod Type** drop-down menu to select the IQ scheme. DG5000 Pro supports 8 modulation schemes: BPSK, QPSK, 8PSK, 16QAM, 32QAM, 64QAM, 128QAM, and 256QAM. Based on your selection, the constellation diagram of the corresponding modulation scheme is displayed in the **Mod** area. For example, the constellation diagram of 8PSK is shown in the figure below.



### Set the Code

In the IQ Setting Menu (*Figure 9.15*), click or tap the **CodeType** drop-down button to select OFF, Differential (Diff), Differential+Gray (Dgray), or Gray.

### Set the Oversampling

Oversampling refers to the interpolation and filtering of the IQ baseband signal to output the signal at a higher sampling rate. If the original IQ baseband signal symbol rate  $R_s$  is raised to a signal with a sample rate of  $f_s=R \times R_s$  after oversampling,  $R$  is the factor by which the signal is oversampled. In the IQ Setting Menu (*Figure 9.15*), click or tap the **Oversampling** input field to set the oversampling. The available range is from 1 to 16, and the default is 4.

**TIP**

The sampling rate is automatically calculated based on the oversampling and symbol rate. The oversampling x symbol rate must be smaller than or equal to the maximum sampling rate (1.25 GSa/s). Otherwise, the system automatically changes the oversampling to meet the requirements.

**Set the Filter**

In the IQ Setting Menu (*Figure 9.15*), click or tap the **FilterType** drop-down button to select the filter type.

- **Rectangular:** Window filter. It passes all signals with frequency lower than a given cutoff frequency, and removes all frequency components above the cutoff frequency. Its frequency response is a rectangular function.
- **Cosine:** Cosine filter. When selecting the cosine filter, you need to set the roll-off factor. The available range is from 0.05 to 1, and the default is 0.25.
- **Root:** Root cosine filter. When selecting the root cosine filter, you need to set the roll-off factor. The available range is from 0.05 to 1, and the default is 0.25.

**Set the Center Frequency**

In the IQ Setting Interface (*Figure 9.14*), click or tap the **CenterFreq** input field to set the center frequency with the pop-up numeric keypad. The available range is from 0 Hz to 500 MHz.

**Set the Power**

In the IQ Setting Interface (*Figure 9.14*), click or tap the **Power** input field to set the power with the pop-up numeric keypad. The available range is from -60 dBm to 25.5 dBm. The actual available range is related to the selected modulation scheme and the center frequency.

## 10 Arb Build

This series Function/Arbitrary Waveform Generator provides the Arb editing function.

Click or tap  > **Arb Build** to enter the Arb Build Interface, as shown in the figure below.

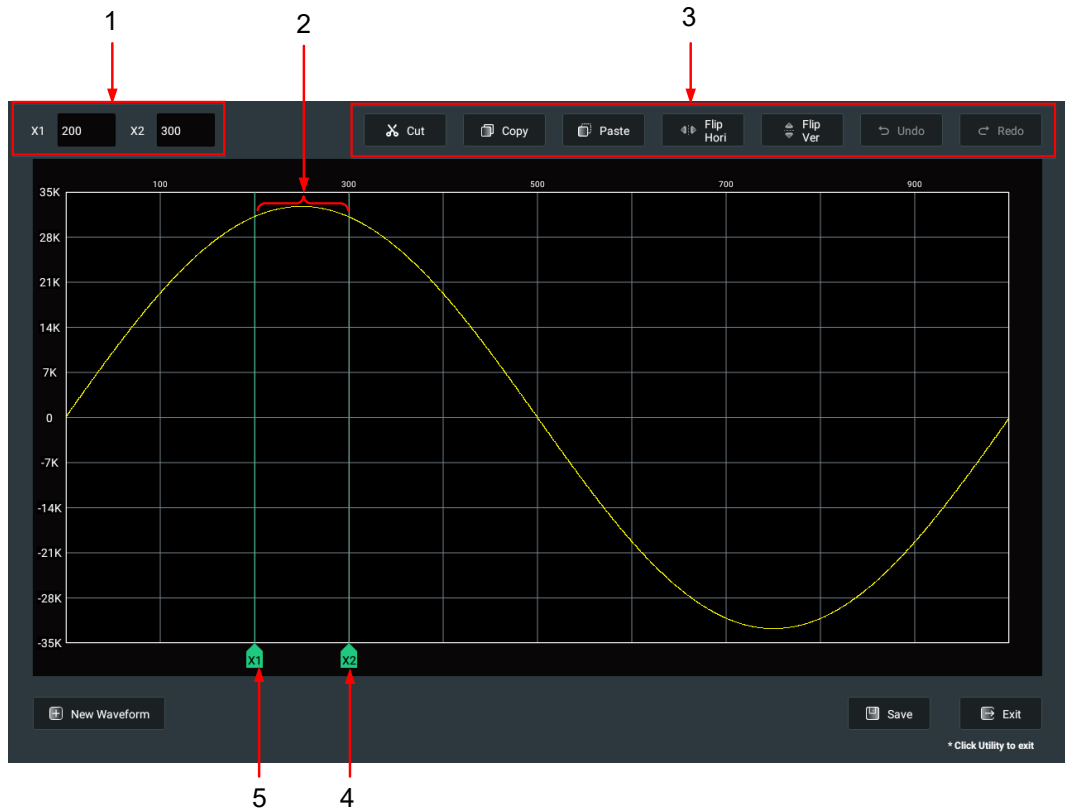

Figure 10.1 Arb Build Interface

1. Cursor horizontal value input fields. The input fields display the horizontal values of the cursor x1 and x2. You can set the two values.
2. Selected Waveform. The waveform between cursor x1 and cursor x2 is the selected waveform. You can edit the selected waveform using the function keys in the menu bar at the top of the interface.
3. Menu bar. You can use the function keys to edit the selected waveform.
4. x2 cursor.
5. x1 cursor.

### Create New Arb Waveform

Click or tap **New Waveform** to open the "Waveform" menu. Click or tap the **Function** input field and select the waveform type in the displayed menu. Set the waveform

length, loop, and other parameters. Then click or tap **Apply** to create a new Arb waveform.



#### TIP

- When the waveform type is set to basic, the maximum of waveform length\*loop is 16,384 pts; otherwise, the waveform length is fixed to 16,384 pts and the loop is fixed to 1.
- The waveform parameters that need to be set depend on the waveform type you select.

#### Edit the Arb Waveform

The newly created waveform will be displayed in the Arb editing area. The selected waveform is between the cursor x1 and the cursor x2, as shown in the figure above. You can select parts of the waveform by dragging the cursor or entering coordinate values in the cursor input field in the upper left corner of the interface to adjust the position of the cursor x1 and cursor x2. You can cut, copy, paste, or flip the selected waveform.

- Cut: Click or tap **Cut** in the menu bar to cut the current waveform to the data cache.
- Copy: Click or tap **Copy** in the menu bar to copy the current waveform to the data cache.
- Paste: Click or tap **Paste** in the menu bar and select the paste location in the pop-up menu. Then click or tap **Apply** to paste the copied or cut waveform to the specified location.

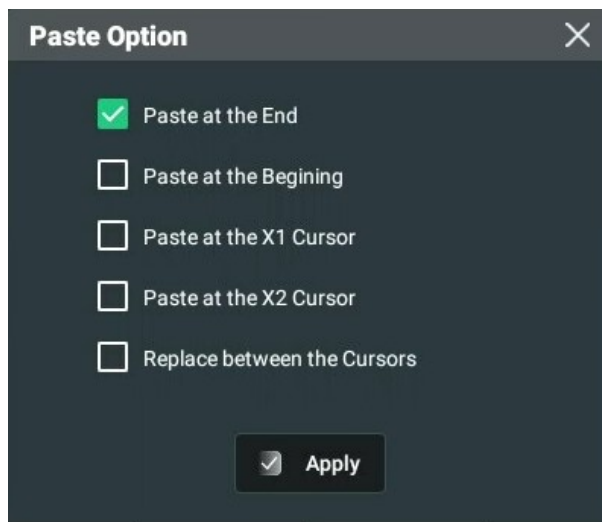

- Flip Horizontal: Click or tap **Flip Hori** in the menu bar to flip the selected waveform horizontally.
- Flip Vertical: Click or tap **Flip Ver** in the menu bar to flip the selected waveform vertically.
- Undo: Click or tap **Undo** in the menu bar to undo the last edit of the Arb waveform. Only one undo operation is allowed.

- Redo: Click or tap **Redo** in the menu bar to cancel the last undo operation. Only one redo operation is allowed.

### Save the Arb Waveform

After the Arb editing, you can save the Arb waveform in the internal/external storage menu in \*.arb file format.

1. In the Arb Build Interface, click or tap **Save** and the "Store" menu is displayed.
2. Enter the target path in the internal/external memory. Click or tap **Save** and the virtual keypad is displayed.
3. Set the Arb name with the pop-up virtual keypad and then click or tap **Enter** to save the self-defined Arb file. Then you can see the Arb file that you saved under the target path.



### TIP

You can also use a PC software (e.g. Ultra Station) to edit the Arb waveform and then use a USB storage device or FTP to transfer the file to the instrument's local memory (C disk).

# 11 Channel Setup

In the user interface, click or tap the Channel Tab to enter the Channel Setup Interface, as shown in the figure below.

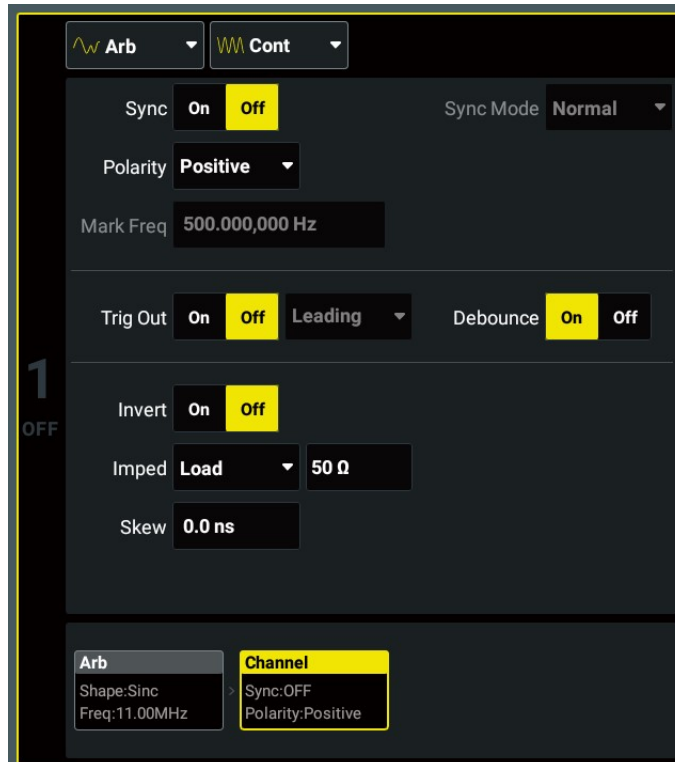

Figure 11.1 Channel Setup Interface

## 11.1 Sync Signal Setup

This series instrument can output the sync signals of basic waveforms (except noise, DC, and harmonic), sweep waveforms, bursts, modulated waveforms, and Advanced Arb waveforms. The instrument outputs the sync signals of each channel via the front-panel **[Sync Out]** connector. You can set the on/off and output polarity for the sync signals of each channel.

### Sync On/Off

Click or tap the **Sync** on/off switch to enable or disable the output of the sync signal. If the Sync function is enabled, the sync signal is output from the front-panel **[Sync Out]** port when the channel output is enabled. For details about the sync signal, refer to [Table 11.1 Sync Signal of Different Output Modes \(Positive Polarity\)](#).

### TIP

When the external trigger source or external modulation source is selected, the sync output is disabled. When the trigger output is enabled, the sync output is disabled automatically.





### Sync Polarity

It sets the output polarity of the sync signal to trigger an external device that may require rising edge trigger or falling edge trigger. Click or tap the **Polarity** drop-down button to select "Positive" or "Negative".

- **Positive:** outputs normal sync signals.
- **Negative:** outputs inverted sync signals.

### Mark Frequency

When the output mode is set to "Sweep", you can set the **sync mode** to "Mark". After the "Mark" function is enabled, the sync signal goes low at the specified mark frequency. For details, please refer to [Mark Frequency](#).

**Table 11.1 Sync Signal of Different Output Modes (Positive Polarity)**

| Output Mode     | Descriptions                                                                                                                                                                                                                                                                                                                                                                                                                                                                                                                                                                                                                                                                                                                                                                                                                                                                                                                                                    |
|-----------------|-----------------------------------------------------------------------------------------------------------------------------------------------------------------------------------------------------------------------------------------------------------------------------------------------------------------------------------------------------------------------------------------------------------------------------------------------------------------------------------------------------------------------------------------------------------------------------------------------------------------------------------------------------------------------------------------------------------------------------------------------------------------------------------------------------------------------------------------------------------------------------------------------------------------------------------------------------------------|
| Continuous Mode | <p>In Continuous mode (except noise, DC, and harmonic), the sync signal is a square waveform with 50% duty cycle. The frequency of the sync signal is related to the waveform output frequency.</p> <ul style="list-style-type: none"> <li>• Output frequency <math>\leq 30</math> MHz: sync signal frequency is equal to the frequency of the output signal.</li> <li>• Output frequency <math>\leq 60</math> MHz: the sync signal frequency is waveform frequency/2.</li> <li>• Output frequency <math>\leq 120</math> MHz: the sync signal frequency is waveform frequency/4.</li> <li>• Output frequency <math>\leq 500</math> MHz: the sync signal frequency is waveform frequency/8.</li> </ul> <p>Note: When square is selected for the Continuous mode and the fast transition is enabled, or when sine is selected and the output frequency is <math>&gt; 5</math> MHz, the sync signal has a fixed delay of 8 ns relative to the waveform signal.</p> |
| Modulation Mode | <p>In Modulation mode, the sync signal is a square waveform with 50% duty cycle. In the first half period of the waveform, the sync signal is a TTL high level.</p> <ul style="list-style-type: none"> <li>• For AM, FM, PM and PWM, the frequency of the sync signal is the modulation frequency.</li> <li>• For ASK, FSK, and PSK, the frequency of the sync signal is the modulation rate.</li> <li>• For SUM, the frequency of the sync signal is the SUM frequency.</li> </ul>                                                                                                                                                                                                                                                                                                                                                                                                                                                                             |

| Output Mode   | Descriptions                                                                                                                                                                                                                                                                                                                                                                                                                                                                                                                                                                                                                                                                                                                                                                                                                                                                                                                                                                                      |
|---------------|---------------------------------------------------------------------------------------------------------------------------------------------------------------------------------------------------------------------------------------------------------------------------------------------------------------------------------------------------------------------------------------------------------------------------------------------------------------------------------------------------------------------------------------------------------------------------------------------------------------------------------------------------------------------------------------------------------------------------------------------------------------------------------------------------------------------------------------------------------------------------------------------------------------------------------------------------------------------------------------------------|
|               | <p><b>TIP</b></p> <p>The sync output is disabled when the channel uses external modulation.</p>                                                                                                                                                                                                                                                                                                                                                                                                                                                                                                                                                                                                                                                                                                                                                                                                                                                                                                   |
| Sweep Mode    | <p>Sweep Internal Trigger Period = 1 ms + Start Hold Time + Sweep Time + Stop Hold Time + Return Time.</p> <ul style="list-style-type: none"> <li>• <b>Sync mode set to "Normal"</b>: When the sweep time starts, the sync signal goes high from a TTL low level and goes low again at the end of the sweep total time.</li> <li>• <b>Sync mode set to "Mark"</b>: When the sweep time starts, the sync signal goes high from a TTL low level and goes low again at the mark frequency. For step sweeps, if the mark frequency is not equal to any of the sweep point values, the sync signal becomes a low level at the sweep point which is less than and closest to the mark frequency when sweeping from high frequency to low frequency or at the sweep point which is greater than and closest to the mark frequency when sweeping from low frequency to high frequency.</li> </ul> <p><b>TIP</b></p> <p>The sync output is disabled when the channel uses the external trigger source.</p> |
| Burst Mode    | <ul style="list-style-type: none"> <li>• <b>Infinite N-Cycle Burst</b>: The sync signal is at a high level for the burst output.</li> <li>• <b>User-defined N-Cycle Burst</b>: The sync signal is a TTL high level at the beginning of the burst. It becomes a TTL low level after a specified number of cycles is completed. When the internal trigger source is selected, the sync signal frequency is the reciprocal of the burst period. Duty cycle is carrier period*cycles/burst period.</li> <li>• <b>Gated Burst</b>: There is no sync signal output.</li> </ul> <p><b>TIP</b></p> <p>The sync output is disabled when the channel uses the external trigger source.</p>                                                                                                                                                                                                                                                                                                                  |
| Advanced Mode | <p>In Advanced mode, the sync signal of the Arb waveform is a square wave with 50% duty cycle, and the frequency of the sync signal is sample rate/waveform points.</p>                                                                                                                                                                                                                                                                                                                                                                                                                                                                                                                                                                                                                                                                                                                                                                                                                           |

## 11.2 Trigger Output Setup

In Burst or Sweep mode, when the trigger source is set to "Internal" or "Manual", the generator outputs a TTL-compatible signal with the specified edge via the front-panel **[Sync Out]** connector.



### NOTE

- In internal trigger, the generator outputs a square waveform with 50% duty cycle via the front-panel **[Sync Out]** connector at the beginning of the burst/sweep.
- In manual trigger, the generator outputs a pulse with greater than 4  $\mu$ s pulse width via the **[Sync Out]** connector at the beginning of the burst/sweep.
- When the trigger source is set to External, the trigger output is disabled. When the sync output is enabled, the trigger output is disabled automatically.



Click or tap the **Trig Out** on/off switch to enable or disable the trigger output function. When the trigger output is enabled, you can specify the edge of the trigger output signal.

- Leading: outputs the trigger signal of the leading edge.
- Trailing: outputs the trigger signal of the trailing edge.

## 11.3 Channel Output Setup

### Enable/Disable the Channel Output

You can enable/disable the channel output in the following ways.

- For 2/4 channel models, press the front-panel channel on/off key  to enable or disable the output of the corresponding channel. For 8 channel models, after the specified channel is selected, press the front-panel channel selection key to enable or disable the output of the corresponding channel. You can also press  to enable or disable the outputs of 8 channels simultaneously.
- Click or tap the channel identifier at the left side of the parameter configuration area.
- Drag the channel label up to enable the output of the corresponding channel or drag the label down to disable the output of the corresponding channel.

### Output Polarity

You can use either the normal mode or invert mode to output signals. Click or tap the **Invert** on/off switch to enable or disable the invert function. The default is "Off".

The waveform is inverted relative to the offset voltage. As shown in the figure below, relative to the offset voltage, the waveform is inverted.

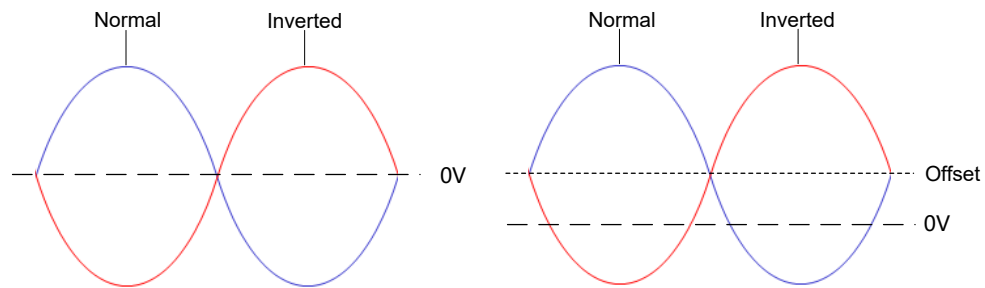
**TIP**

- Setting the waveform invert does not invert the sync signals related to the waveform. To invert the sync signal, refer to *Sync Polarity*. Set the polarity of the sync signal to "negative".
- The offset voltage remains unchanged when the waveform is inverted.

**Output Impedance**

The output impedance setting affects the output amplitude and DC offset. This instrument has a fixed series output impedance of 50  $\Omega$  to the front-panel BNC output connector. If the actual load impedance differs from the value specified, the voltage level displayed would not match the voltage level of the device under test. To ensure correct voltage level, the load impedance setting must match the actual load.

Click or tap **Imped** drop-down button to select "HighZ" or "Load". If "Load" is selected, you can click or tap the **Imped** input field to define the impedance. The range is from 1  $\Omega$  to 10 k $\Omega$ .

**NOTE**

- After that, the instrument will adjust the output amplitude and offset voltage automatically. For example, the current amplitude is 5 Vpp. At this point, change the output impedance from 50  $\Omega$  to HighZ and the amplitude displayed in the input field will be doubled to 10 Vpp. If the output impedance is changed from HighZ to 50  $\Omega$ , the amplitude will be reduced to half of the previous value (2.5 Vpp). Note that only the displayed values change with the parameter and the actual output from the generator does not change.
- If the impedance is set to "HighZ", the amplitude unit cannot be set to "dBm".
- When the IQ mode is selected for the specified channel, the output impedance is fixed to 50  $\Omega$  and cannot be modified.

**Debounce Function**

When the output of the generator is enabled before the relay has fully settled, initiating the DDS output may result in high-frequency ringing on the signal edges, impacting the test stability.

This instrument provides the debounce function. Click or tap the **Debounce** on/off switch to enable or disable the debounce function. When the debounce function is disabled, the DDS begins outputting the target waveform immediately after the output enable command is issued. If the relay has not fully settled at this point,

ringing may occur. When the debounce function is enabled, the corresponding channel first closes the relay (establishing the output path), and after it has stabilized, the DDS then starts outputting the target waveform. This mechanism effectively suppresses ringing in the output waveform.

**TIP**

- The debounce function is enabled by default, and its status is not affected by the operation of restoring the default value or loading the configuration file.
- When the debounce function is enabled, there will be a period of idle level output before the target signal is output. The rules are as follows:
  - For the square wave with the fast transition enabled, the idle level is fixed to the low level of the square wave.
  - For Burst and Multi-pulse waveforms, the idle level will follow the idle level settings specified in their respective functions.
  - For waveforms other than Burst, Multi-pulse, and Square (fast transition enabled), when the low level is greater than 0 V, the idle level is the low level of the waveform. When the high level is less than 0 V, the idle level is the high level of the waveform. When the low level is less than or equal to 0 V and the high level is greater than or equal to 0 V, the idle level is 0 V.

**Channel-to-channel Skew**

Channel-to-channel skew is used to control the time difference between multiple output channels for multi-channel synchronization. You can adjust the relative timing of the signal output precisely by setting the delay time for different channels.

In the Channel Setup Interface, click or tap the **Skew** input field to set the channel-to-channel skew. The range is from -200 ns to 200 ns.

**TIP**

- The actual precision of the channel-to-channel skew is  $\pm 200$  ps.
- The channel skew is not affected by the operation of restoring the default value or loading the configuration file.

## 12 Channel Copy

DG5000 Pro provides the Channel Copy function. It allows you to copy the states and waveform parameters of one channel (source channel) to the other channel (target channel), minimizing repetitive operations in multi-channel configurations. Refer to the following table ([Table 12.1 Multi-channel Operation Parameters](#)) for parameters that can be copied.

Click or tap **Channel Copy** (or the front-panel **Copy** key for 2-channel/4-channel models) at the bottom of the screen to open the Channel Copy Menu, as shown in the figure below. Click or tap the channel selection drop-down buttons to select the source channel and the target channel respectively. For example, CH1→CH2 indicates selecting CH1 as the source channel and CH2 as the target channel. After that, click or tap **Apply** to copy the states and waveform parameters of the source channel to the target channel.

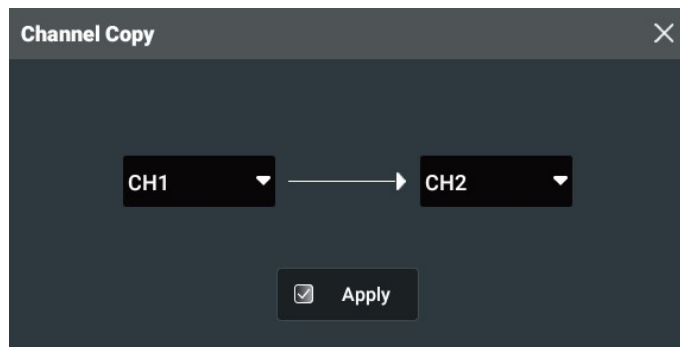

Figure 12.1 Channel Copy Menu



### TIP

- If a channel's output mode is set to Advanced or the channel track function is enabled, it cannot be used as the source channel for the channel copy function.
- If a channel is set as the benchmark channel of the Bundled Channels or has channel track or coupling function enabled, it cannot be used as the target channel for the channel copy function. For how to configure the Bundled Channels, please refer to [Bundle By Source Setup](#).
- For two-channel models, the source channel of the channel copy function is the benchmark channel of the Bundled Channels. To modify the source channel, please switch the benchmark channel in the Bundle By Source menu ([Bundle By Source Setup](#)). The target channel will be automatically configured according to the benchmark channel you select.

### Table 12.1 Multi-channel Operation Parameters

(√ indicates available; × indicates not available)

| Parameter                       | Track    | Copy                              |
|---------------------------------|----------|-----------------------------------|
| <b>Basic Functions</b>          |          |                                   |
| Channel Output State            | ×        | ×                                 |
| Output Mode                     | √        | √                                 |
| Basic Waveform                  | √        | √                                 |
| Frequency Display Mode          | √        | √                                 |
| Frequency Value                 | √        | √                                 |
| Frequency Coupling              | Disabled | Not available when Coupling is on |
| Period                          | √        | √                                 |
| Amplitude Display Mode          | √        | √                                 |
| Amplitude Value                 | √        | √                                 |
| Amplitude Unit                  | √        | √                                 |
| Amplitude Coupling              | Disabled | Not available when Coupling is on |
| Offset                          | √        | √                                 |
| High Level                      | √        | √                                 |
| Low Level                       | √        | √                                 |
| Phase                           | √        | √                                 |
| Phase Coupling                  | Disabled | Not available when Coupling is on |
| Square Duty Cycle               | √        | √                                 |
| Square Fast Transition On/Off   | √        | √                                 |
| Square Transition Time          | √        | √                                 |
| Ramp Symmetry                   | √        | √                                 |
| Pulse Width Display Mode        | √        | √                                 |
| Pulse Width                     | √        | √                                 |
| Pulse Duty Cycle                | √        | √                                 |
| Rising Edge                     | √        | √                                 |
| Trailing Edge                   | √        | √                                 |
| Built-in Arb Type               | √        | √                                 |
| Harmonic Type                   | √        | √                                 |
| Harmonic Order                  | √        | √                                 |
| Harmonic Combination            | √        | √                                 |
| Order Harmonic Amplitude        | √        | √                                 |
| Order Harmonic Phase            | √        | √                                 |
| Combine Harmonic Amplitude List | √        | √                                 |
| Combine Harmonic Phase List     | √        | √                                 |
| <b>Burst</b>                    |          |                                   |
| State                           | √        | √                                 |
| Mode                            | √        | √                                 |
| (Trigger) Source                | √        | √                                 |
| Burst Delay                     | √        | √                                 |

| Parameter                                    | Track | Copy |
|----------------------------------------------|-------|------|
| Cycles                                       | √     | √    |
| Burst Period                                 | √     | √    |
| Phase                                        | √     | √    |
| Gated Polarity                               | √     | √    |
| Idle Level                                   | √     | √    |
| <b>Sweep</b>                                 |       |      |
| State                                        | √     | √    |
| Mode                                         | √     | √    |
| (Trigger) Source                             | √     | √    |
| Frequency Display Mode                       | √     | √    |
| Start Frequency                              | √     | √    |
| Stop Frequency                               | √     | √    |
| Center Frequency                             | √     | √    |
| Frequency Span                               | √     | √    |
| No. of Steps                                 | √     | √    |
| Start Hold Time                              | √     | √    |
| Stop Hold Time                               | √     | √    |
| Sweep Time                                   | √     | √    |
| Return Time                                  | √     | √    |
| Mark Frequency                               | √     | √    |
| <b>Modulation</b>                            |       |      |
| State                                        | √     | √    |
| Modulation Type                              | √     | √    |
| Modulation Source                            | √     | √    |
| Modulating Waveform                          | √     | √    |
| Modulation Frequency                         | √     | √    |
| Modulation Depth                             | √     | √    |
| DSSC                                         | √     | √    |
| Frequency Deviation                          | √     | √    |
| Phase Deviation                              | √     | √    |
| Duty Cycle Deviation/Width Deviation Display | √     | √    |
| Duty Cycle Deviation                         | √     | √    |
| Width Deviation                              | √     | √    |
| Modulation Rate                              | √     | √    |
| Modulation Port                              | √     | √    |
| Modulation Polarity                          | √     | √    |
| Modulation Amplitude                         | √     | √    |
| Hop Frequency                                | √     | √    |
| Phase                                        | √     | √    |
| SUM Waveform                                 | √     | √    |
| SUM Frequency                                | √     | √    |



| Parameter             | Track | Copy |
|-----------------------|-------|------|
| SUM Ratio             | √     | √    |
| <b>Channel</b>        |       |      |
| Sync On/Off           | √     | ×    |
| Sync Mode             | √     | ×    |
| Sync Polarity         | √     | ×    |
| Trigger Output On/Off | √     | √    |
| Trigger Output Edge   | √     | √    |
| Invert                | √     | ×    |
| Impedance             | √     | √    |
| Channel Skew          | √     | √    |
| Debounce              | ×     | ×    |

## 13 Bundle By Source Setup

DG5000 Pro supports the Bundle By Source function. The *Align Phase* operation takes effect for all channels that have been added to the Bundled Channels. You can also set the coupling and track functions for channels added to the Bundled Channels. The coupling or track function allows you to pass parameters from one channel to the

other according to your requirements. Click or tap  > **Bundle By Source** to open the Bundle By Source Menu, as shown in the figure below.

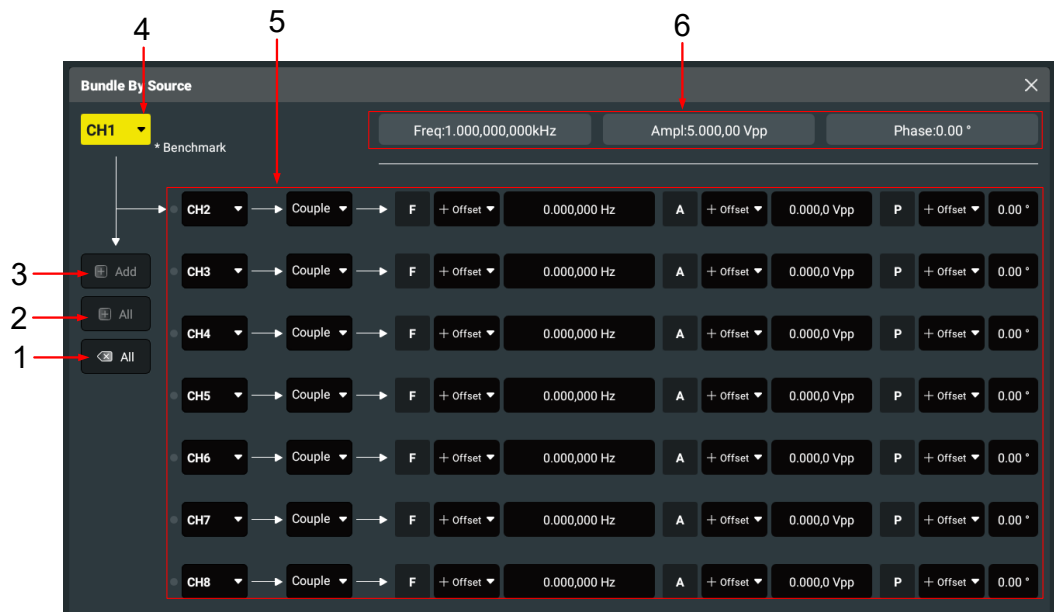

**Figure 13.1 Bundle By Source Menu**

1. Delete key. If multiple channels have been added to the Bundled Channels, you can click or tap this key to delete all channels (except the benchmark channel).
2. All Channel Add Key. Click or tap this key to add all channels to the Bundled Channels (the benchmark channel is added automatically).
3. Channel Add Key. Click or tap this key and a channel selection menu will be displayed. You can select a channel to add to the Bundled Channels.
4. Benchmark Channel Drop-down Button. Displays the current benchmark channel. You can click or tap the drop-down button to select the specified channel to add to the Bundled Channels and serve as the benchmark channel for the Bundled Channels. Note that switching the benchmark channel turns off the track and coupling functions currently enabled and clears channels other than the benchmark channel in the Bundled Channels.
5. Bundled Channels Setup Area. Displays all target channels that have been added to the Bundled Channels. You can set the coupling and track parameters in this area.

6. Benchmark Channel Parameter Preview. Displays the frequency, amplitude, and phase parameters of the benchmark channel in real time.

**TIP**

- When a channel is removed from the Bundled Channels, the coupling or track function for that channel is automatically turned off.
- When a channel is added to the Bundled Channels Setup Area, you can also click or tap any channel drop-down button in the area. In the pop-up menu, you can either switch the channel to add to the Bundled Channels or select **Delete** to remove the current channel from the Bundled Channels.

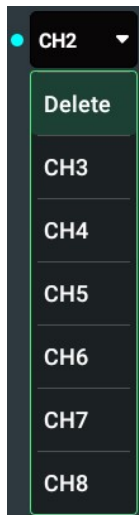

## 13.1 Coupling Setup

DG5000 Pro supports frequency, amplitude, and phase coupling. When the Coupling function is enabled, if the frequency, amplitude, or phase of one channel is changed, the parameter of other coupled channels will be adjusted automatically based on the preset offset or ratio. This section describes how to set coupling.

In the Bundle By Source Menu, click or tap the Coupling/Track drop-down button to select "Couple". The Coupling Setup Interface is as shown in the figure below (taking adding CH2 as an example).

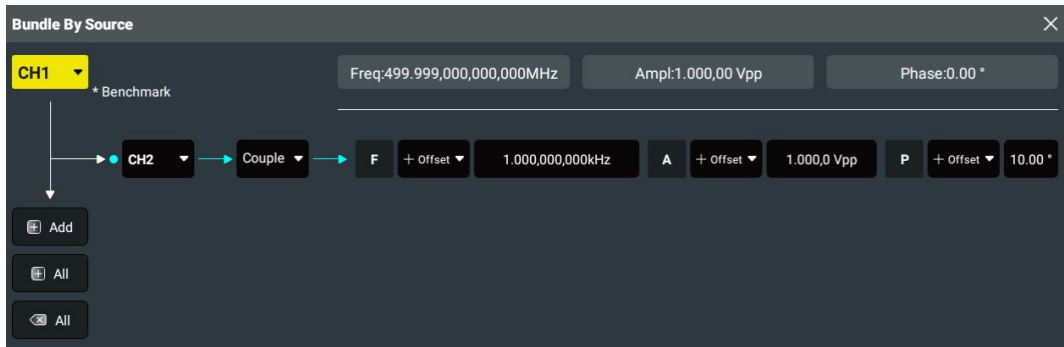

Figure 13.2 Coupling Setup Interface



**NOTE**

The Coupling function is available only when the output mode of both the benchmark channel and the target channel is set to "Continuous". The following table shows the relationship between the coupling mode and the waveform shape.

(√ indicates available; × indicates not available)

| Coupling Function  | Sine | Square | Ramp | Pulse | Noise | Arb | DC | Harmonic |
|--------------------|------|--------|------|-------|-------|-----|----|----------|
| Frequency Coupling | √    | √      | √    | ×     | ×     | ×   | ×  | ×        |
| Amplitude Coupling | √    | √      | √    | ×     | √     | √   | ×  | ×        |
| Phase Coupling     | √    | √      | √    | ×     | ×     | ×   | ×  | ×        |

**Frequency Coupling (F)**



Frequency coupling allows you to couple frequencies between channels, either by a constant offset or ratio between them.

- In the Coupling Setup Interface, click or tap **F** to enable or disable the frequency coupling function for the specified channel. When the function is enabled, **F** is highlighted.
- Click or tap the **F** drop-down button to select offset or ratio for the frequency coupling.
- When "Offset" or "Ratio" is selected for the frequency coupling, click or tap the **F** input field to set the offset or ratio.

- Offset: the frequency offset between the coupled channel and the benchmark channel. Set the frequency of the benchmark channel to  $F_{\text{basic}}$  and the frequency offset of a coupled channel to  $F_{\text{offs}}$ , then the frequency of the coupled channel is  $F = F_{\text{basic}} + F_{\text{offs}}$ .
- Ratio: frequency ratio of the coupled channel to the benchmark channel. Set the frequency of the benchmark channel to  $F_{\text{basic}}$  and the frequency ratio of a coupled channel to  $F_{\text{ratio}}$ , then the frequency of the coupled channel is  $F = F_{\text{basic}} * F_{\text{ratio}}$ . The ratio ranges from 0.001 to 1000.

### Amplitude Coupling (A)



Amplitude coupling allows you to couple amplitudes between channels, either by a constant offset or ratio between them.

- In the Coupling Setup Interface, click or tap **A** to enable or disable the amplitude coupling function for the specified channel. When the function is enabled, **A** is highlighted.
- Click or tap the **A** drop-down button to select offset or ratio for the amplitude coupling.
- When "Offset" or "Ratio" is selected for the amplitude coupling, click or tap the **A** input field to set the offset or ratio.
  - Offset: the amplitude offset between the coupled channel and the benchmark channel. Set the amplitude of the benchmark channel to  $A_{\text{basic}}$  and the amplitude offset of a coupled channel to  $A_{\text{offs}}$ , then the amplitude of the coupled channel is  $A = A_{\text{basic}} + A_{\text{offs}}$ .
  - Ratio: amplitude ratio of the coupled channel to the benchmark channel. Set the amplitude of benchmark channel to  $A_{\text{basic}}$  and the amplitude ratio of a coupled channel to  $A_{\text{ratio}}$ , then the amplitude of the coupled channel is  $A = A_{\text{basic}} * A_{\text{ratio}}$ . Amplitude ratio ranges from 0.001 to 1000.



#### NOTE

The offset values of the amplitude coupling are measured when the impedance is HighZ and the amplitude unit is Vpp.

### Phase Coupling (P)

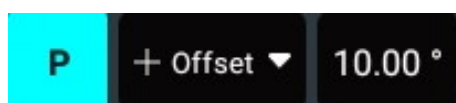

Phase coupling allows you to couple phases between channels, either by a constant offset or ratio between them.

- In the Coupling Setup Interface, click or tap **P** to enable or disable the phase coupling function for the specified channel. When the function is enabled, **P** is highlighted.
- Click or tap the **P** drop-down button to select offset or ratio for the phase coupling.
- When "Offset" or "Ratio" is selected for the phase coupling, click or tap the **P** input field to set the offset or ratio.
  - Offset: the phase offset between the coupled channel and the benchmark channel. Set the phase of the benchmark channel to  $P_{\text{basic}}$  and the phase offset of a coupled channel to  $P_{\text{offs}}$ , then the phase of the coupled channel is  $P = P_{\text{basic}} + P_{\text{offs}}$ .
  - Ratio: phase ratio of the coupled channel to the benchmark channel. Set the phase of the benchmark channel to  $P_{\text{basic}}$  and the phase ratio of a coupled channel to  $P_{\text{ratio}}$ , then the phase of the coupled channel is  $P = P_{\text{basic}} * P_{\text{ratio}}$ . The ratio ranges from 0.01 to 100.



#### TIP

- When the Coupling function is enabled, if the frequency, amplitude, or phase of the coupled channel exceeds the upper/lower limit after calculation according to the ratio or offset, the generator will automatically adjust the waveform parameters of the benchmark channel to avoid parameter overlimit of the benchmark channel and other channels with the coupling/track function enabled. If the adjusted waveform parameters will still exceed the limit, then this ratio or offset is not allowed.
- When the Coupling function is enabled, if parameter overlimit occurs due to waveform switching or parameter adjustments, the system automatically turns off the corresponding coupling switch.
- When the Coupling function is disabled, it cannot be enabled if the coupling parameter exceeds the limit.
- When the Track function is enabled, the Coupling function of the channel is disabled. When the Coupling function is enabled, the channel cannot be used as the target channel for the channel copy function.

## 13.2 Channel Track

When the Track function is enabled, the parameters of the benchmark channel (see [Table 12.1 Multi-channel Operation Parameters](#)) are copied to the track channel in real time while the track channel cannot be operated (except the channel on/off status) at this point. The modifications to the benchmark channel also apply to the

track channel. The Track function makes it easier to configure the same parameters for multiple channels.

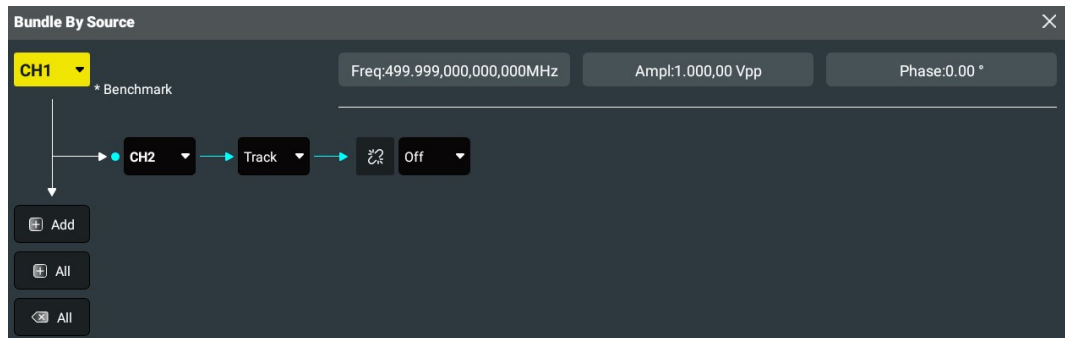

**Figure 13.3 Channel Track Setup Interface**

In the Bundle By Source Menu, click or tap the Coupling/Track drop-down button to select "Track". The Channel Track Setup Interface is as shown in the figure below (taking adding CH2 as an example).

In the Channel Track Setup Interface (*Figure 13.3*), you can click or tap the track status icon of the **Track** item to enable or disable the Track function. You can also click or tap the drop-down button to select "On", "Inverted", or "Off" for the Track function. When "On" or "Inverted" is selected, the track status icon is highlighted.

- **On** (🔗): enables the Track function. When the Track function is enabled for the specified channel, the instrument automatically copies the parameters and states (except the channel output on/off state) of the benchmark channel to the channel. When the parameters and states of the benchmark channel are modified, the modifications also apply to target channel. In this way, the benchmark channel and the target channel can output identical signals (output enabled).
- **Inverted** (🔗<sub>inv</sub>): The Track function is enabled, but the target channel and the benchmark channel have opposite output polarities.

Note that Enabling the "Inverted" function automatically adjusts the "Invert" on/off of the target channel. After disabling the Track function, you need to modify the "Invert" on/off setting of the target channel.

- **Off** (🔗<sub>off</sub>): disables the Track function. It is the default setting.



#### TIP

- When the coupling mode (*Coupling Setup*) is enabled, enabling the Track function automatically disables the channel coupling function.
- When the output mode of the benchmark channel is set to "Advanced", the Track function is disabled.

## 14 Align Phase

DG5000 Pro provides the Align Phase function. Click or tap the **Align Phase** key or press the front-panel **Align** key. The instrument will adjust the phase settings of all channels added to the Bundled Channels and set an internal zero-phase reference point. The align phase function is not available for channels which use external trigger, manual trigger, or external modulation. If any channel of the Bundled Channels has the state mentioned above and output is enabled, then the align phase operation will be invalid. You have to remove the channel from the Bundled Channels or modify the channel state before performing the align phase operation.

For multiple signals whose frequencies are identical or in multiples, you can use this function to align their phases. For example, the instrument outputs a sine waveform (1 kHz, 5 Vpp) with  $0^\circ$  phase from CH1 and a sine waveform (1 kHz, 5 Vpp) with  $180^\circ$  phase from CH2. Use an oscilloscope to acquire waveforms from the two channels and then display the acquired two waveforms. You will see that the waveforms shown on the oscilloscope do not always have a phase deviation of  $180^\circ$ . At this point, click or tap the **Align Phase** key. The waveforms shown on the oscilloscope will have a phase deviation of  $180^\circ$  without any adjustment of the start phase of the generator.

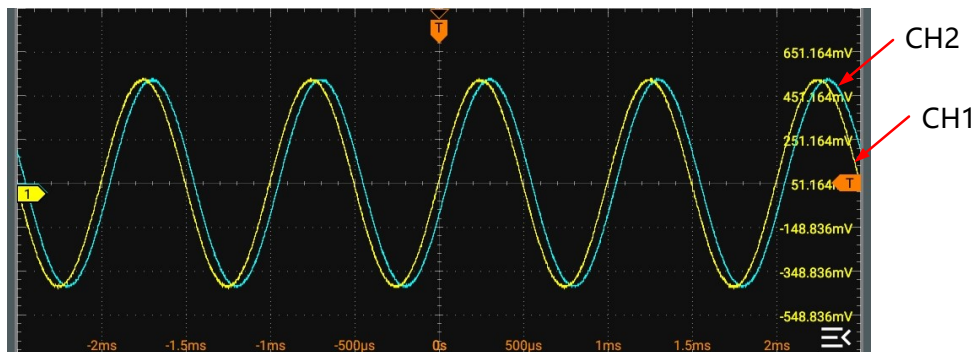

Figure 14.1 Before Aligning Phase

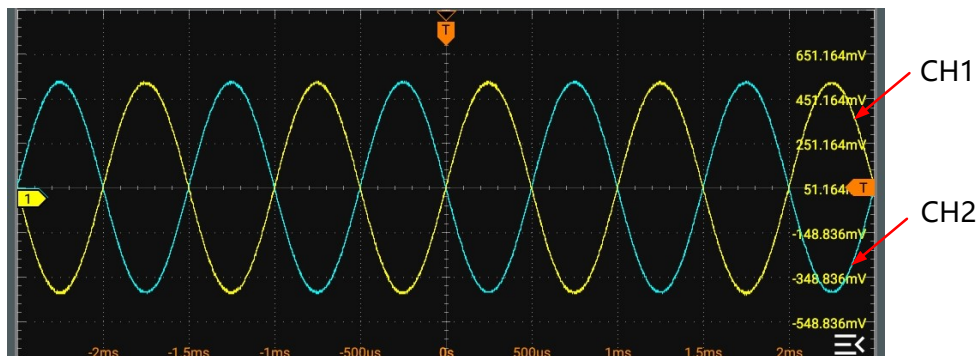



Figure 14.2 After Aligning Phase



## 15 Storage Management

You can store the screen capture, self-defined sequences and waveforms to the internal memory or external storage device. This series provides a USB HOST interface on the front panel used to connect the USB storage device for external storage. The local directory is "Local Disk (C)" and the external storage device is displayed as "USB Disk (D)".

You can access the "Store" menu in the following ways.

- Click or tap **Store/Recall** at the bottom of the interface to enter the "Store" menu.
- Press the front-panel  key to enter the "Store" menu.



### TIP

This instrument can only identify the file whose name contains English letters (including numbers and underscores). The file or folder named by Chinese characters or other characters cannot appear in the storage menu.

### 15.1 To Select the File

You need to select the desired file/folder(s) before any further operation.

#### 1. Select the Disk

By default, the menu displays the content of "Local Disk(C)". You can switch to the external storage device in the drop-down menu at the upper-left side of the menu. For example, after "USB Disk(D)" is selected, the menu will display the content of the external storage device-D disk.



### TIP

Before using the external storage device, please make sure that the USB storage device (FAT32, NTFS or exFAT format) is properly connected.

#### 2. Enter the Target Directory

Click or tap the folder to enter the target directory.

#### 3. Select the File/Folder

Tick the check box next to the file or folder and the box will be displayed as . You can click or tap the box again to cancel the selection. The check box restores to its original state.



### TIP

You can also tick the icon at the upper-right side of the menu to select all the files and folders under the current directory. Click or tap  again to cancel the select-all operation.

## 15.2 To Transfer Files with FTP

Apart from using the USB storage device, you can also use the File Transfer Protocol (FTP) to connect DG5000 Pro to your PC, transferring files in either direction. You can also use the File Explorer of the PC or dedicated FTP transfer software to transfer files. For more stable transmission, it is recommended to use the FTP software. This section takes the Xftp 8 software as an example to illustrate how to transfer files between DG5000 Pro and PC.

### Preparations

1. Make sure that the Xftp 8 has been installed on your PC. If not, please visit the official website of the software to download and install it.
2. Make sure that your DG5000 Pro is connected to the LAN. Click or tap  > **Utility** > **I/O** and check the IP address of the instrument from the **IP Address** item.

### File Transfer Procedures

#### 1. Create session.

Open the installed Xftp 8 software. Click **File** > **New** and the "Properties of New Session" dialog box is displayed. Configure the following properties and then click **OK** to create a new session.

- Host: Enter the IP address of DG5000 Pro.
- Protocol: Select FTP.
- User Name/Password: Enter the user name and password of DG5000 Pro. The user name is "admin" and the password is "rigol" by default.

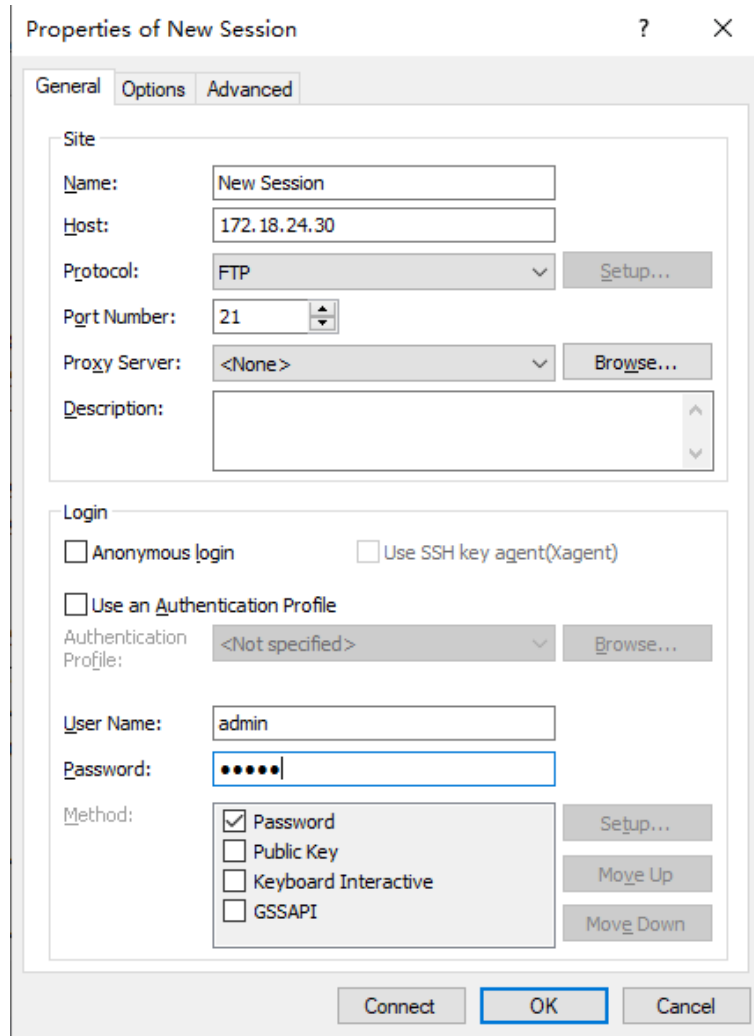

**Figure 15.1 Create Session**

## 2. Make connection.

Select the new session and click **Connect**. After connection, you can browse files on your local computer and DG5000 Pro in the XFtp 8 interface.

## 3. Transfer file.

Drag the selected files from a window to another to upload and download the files between the PC and DG5000 Pro.

## 4. Disconnect.

After the file transfer is complete, you can close the session to disconnect from DG5000 Pro.

### TIP



You can also use other software to transfer files. For details, see the user manual of the corresponding software.

## 15.3 To Create New Folder

---

You can create new folders in the menu. Click or tap **New directory** at the bottom of the menu and set the folder name (Chinese characters not supported) with the pop-up virtual keypad. A new folder will be created under the current path with the file name.

## 15.4 Cut and Copy

---

### Cut a File to a Specified Directory

Select a specified file. Click or tap **Cut** and then access the target directory. Click or tap **Paste** to complete the operation.

### Copy a File to a Specified Directory

Select a specified file. Click or tap **Copy** and then access the target directory. Click or tap **Paste** to complete the operation.

## 15.5 Rename

---

Select a specified file. Click or tap **Rename** and set the name with the pop-up virtual keypad. DG5000 Pro does not support Chinese characters.

## 15.6 Delete

---

Under the current directory, select the file or folder (empty) that you want to delete. Click or tap **Delete** to delete the selected file or folder. You cannot delete folders that are not empty.

## 16 Upgrade



---

You can upgrade the system following the steps below.

1. Ensure that the USB device is correctly connected to the instrument.
2. Then click or tap **Store/Recall** at the bottom of the interface or press the front-panel  key to enter the "Store" menu.
3. Refer to *Storage Management*. Select the upgrade file and then click or tap **Upgrade**. In the pop-up menu, click or tap **OK** to perform the local upgrade operation.

## 17 System Utility Function Setting

In the "Utility" menu, you can set the I/O parameters and the system-related function parameters. To enter the "Utility" menu, perform the following operations.

- Click or tap the notification area at the lower-right corner of the interface to enter the "Utility" menu.
- Press the front-panel  key to enter the "Utility" menu.
- Click or tap the function navigation icon  at the lower-left corner of the interface, and then select **Utility** to enter the "Utility" menu.

### 17.1 I/O Setting

In the **Utility** menu, click or tap **I/O** to enter the I/O setting menu to configure the following parameters.

#### Network Status

Different prompts will be displayed according to the current network connection status.

- Network Config Succeeded!
- Acquiring IP..
- IP Conflict!
- DISCONNECTED!
- DHCP Config Failed
- Read Status Fail!
- CONNECTED
- Invalid IP
- IP lost
- Please wait...

#### IP Configuration Type

The configuration type of the IP address can be DHCP, Auto IP, or Static IP. In different IP configuration types, the configurations for IP address and other network parameters are different.

- **DHCP**

If "DHCP" is selected, the DHCP server in the current network will assign the network parameters (e.g. IP address, Subnet, Gateway, and DNS) for the instrument.

- **Auto IP**

When "Auto IP" is selected, the instrument will acquire the IP address ranging from "169.254.0.1" to "169.254.255.254" and the subnet mask (255.255.0.0) automatically based on the current network configuration. The "Auto IP" works only when "DHCP" is not selected or connection is failed.

- **Static IP**

If "Static IP" is selected, the instrument is configured with static IP. In this case, you need to disable DHCP and Auto IP manually. Then you need to configure the parameters such as "IP address", "Subnet", "Gateway", and "DNS" manually. At this time, you can self-define the network parameters (e.g. IP address) of the instrument.

- **Set the IP address**

The format of the IP address is nnn.nnn.nnn.nnn. The range of the first segment (nnn) of the address is from 0 to 255 (except 127); wherein, the valid range is from 0 to 223. The range for the other three segments is from 0 to 255. You are recommended to ask your network administrator for an IP address available.

- **Set the subnet mask**

The format of the subnet mask is nnn.nnn.nnn.nnn. Wherein, the range of "nnn" is from 0 to 255. You are recommended to ask your network administrator for a subnet mask available.

- **Set the default gateway**

You can set this parameter in Static IP mode. The format of the gateway is nnn.nnn.nnn.nnn. The range of the first segment (nnn) is from 0 to 223 (except 127), and the range for the other three segments is from 0 to 255. You are recommended to ask your network administrator for a gate address available.

- **Set the DNS address**

You can set this parameter in Static IP mode. The format of the DNS address is "nnn.nnn.nnn.nnn". The range for the first segment (nnn) of the address is from 0 to 223 (except 127); and the range for the other three segments is from 0 to 255. You are recommended to ask your network administrator for an address available.

Generally, you do not need to set the DNS, therefore this parameter setting can be ignored.

**TIP**

- When the three IP configuration types are all turned on, the priority of the parameter configuration from high to low is "DHCP", "Auto IP", and "Static IP".
- The three IP configuration types cannot be all turned off at the same time.

**MAC Address**

Displays the MAC address by the instrument. For each instrument, the MAC address is unique. When assigning the IP address for the instrument, the system uses the MAC address to identify the instrument.

**VISA Address**

Displays the VISA address currently used by the instrument.

**Reset the Network Parameter Setting**

Click or tap **Reset** to cancel the current parameter setting and restore it to the default setting.

**Apply the Network Parameter Setting**

Click or tap **Apply** to validate the current network parameter setting.

## 17.2 LXI

In the **Utility** menu, click or tap **LXI** to enter the LXI setting menu and configure the following parameters.

**mDNS**

Click or tap the mDNS on/off switch to enable or disable the multicast Domain Name System (mDNS). This system is used to provide the function of DNS server for service discovery in a small network without a DNS server.

**Host Name**

Click or tap the **Host Name** input field to set the host name. A maximum of 28-byte strings can be supported. When mDNS is enabled, you can also input "hostname.local" into the browser address bar to access Web Control.

**Service Name**

After the mDNS function is enabled, click or tap the **Service Name** input field to set the service name.

## 17.3 Basic Settings

In the **Utility** menu, click or tap **Setup** to access the basic setting menu.



## Language

This instrument supports two languages. Both Chinese and English are available for the display of the help information, prompt messages, and interface. Click or tap the drop-down button of **Language** to select the specified system language.

## Load Last

You can set the system configuration to be recalled when the instrument is powered on again after power-off. Click or tap the **Load Last** drop-down button to select "Default" or "Last". The default setting is "Last".

- **Last:** returns to the setting of the system at last power-off.
- **Default:** returns to the factory setting of the system.

## Power Setting

Click or tap the **Power Set** drop-down button to select "Auto" or "Manual".

- **Manual:** After the instrument is connected to power, you need to press the power key to power on the instrument.
- **Auto:** After the instrument is connected to power, it will be powered on immediately.

This setting is stored in the non-volatile memory. It is not affected by the "restore factory defaults" operation.

## Clock Source

This series generator provides an internal clock source (10 MHz) and accepts the external clock source from the rear-panel **[10 MHZ REF IN]** connector. It also outputs the clock source via the **[10 MHZ REF OUT]** connector for the use of other equipment. Click or tap the **Clk Src** drop-down button to select "Internal" or "External". The default setting is "Internal".

### CAUTION

**When using an external source, it is necessary to first connect an external 10 MHz clock and then set the **Clk Src** to "External"; otherwise, it may cause abnormal waveform output.**

### TIP

You can synchronize two or more instruments by setting the clock source. When two instruments are synchronized, the "Align Phase" function can not be used. "Align phase" can only be used to adjust the phase relationship between two output channels of the same instrument but cannot change the phase relationship between the output channels of two instruments. Of course, you can change the phase relationship between two instruments by changing the "Start Phase" of each channel.

Follow the steps below to synchronize two or more instruments.



- **Synchronize two instruments:**

Connect the [10 MHZ REF OUT] connector of Generator A ("Internal" clock source) to the [10 MHZ REF IN] connector of Generator B ("External" clock source) and then set identical output frequencies for the two instruments to realize their synchronization.

- **Synchronize multiple instruments:**

Divide the 10 MHz clock source of a generator ("Internal" clock source) into multiple channels, and then connect them to the [10 MHz REF IIN] connectors of other generators ("External" clock source) respectively, and finally set identical output frequencies for the instruments to realize synchronization among multiple instruments.

### Number Format

You can set the display format of the decimal point and thousands separator in number parameters. This setting is stored in the non-volatile memory. It is not affected by the "restore factory defaults" operation.

- **Decimal Point:** click or tap the **Decimal** drop-down button to select "." or ",". The default setting is ".".
- **Thousands Separator:** click or tap the **Separator** drop-down button to select ".", ",", "Space", or "None". They cannot be set to "." or "," at the same time.

### Brightness



Click or tap the **Brightness** input field to set the brightness of the display.

### Beeper

Click or tap the **Beeper** on/off switch to turn on or off the beeper. When it is on, you can hear the beeper sound when operating the instrument or an error occurs.

### Date and Time

Click or tap the **Show Time** on/off switch to turn on/off showing the date and time on the screen. When it is on, the system time is displayed in "hh:mm" format, and the date is displayed in "yyyy-mm-dd" format in the Notification Area at the lower-right corner of the screen. You can self-define the system date and time.

- **Date:** click or tap the **Date** input field and the date setting menu is displayed. Adjust the date and then click or tap **OK** to complete the date setting.  
Otherwise, click or tap  to close the menu and cancel the modifications.
- **Time:** click or tap the **Time** input field and the time setting menu is displayed. Adjust the time and then click or tap **OK** to complete the time setting.  
Otherwise, click or tap  to close the menu and cancel the modifications.

## 17.4 About this Instrument

---

In **Utility** menu, click or tap **About**, and then you can view the model, version, and other information about this instrument.

- **Device Model**  
Indicates the product model.
- **Serial number**  
Indicates the serial number of the product, the unique identification for the product.
- **Calibration Date**  
Indicates the last calibration date.
- **Analog Hardware Version**  
Indicates the analog hardware version number of the product.
- **Digital Hardware Version**  
Indicates the digital hardware version number of the product.
- **Main Board Version**  
Indicates the version number of the main board.
- **Sub Card Version**  
Indicates the version number of the daughter card.
- **FGen Subsystem Version**  
Indicates the function generator version number.
- **UI Subsystem Version**  
Indicates the user interface version number.
- **WebServer Subsystem Version**  
Indicates the version number of the network service system.
- **Runtime System Version**  
Indicates the version number of the operation system.

## 17.5 Print Screen

---

You can capture the current screen and save the image to the memory in different formats. In the **Utility** menu, click or tap **Print Screen** to enter the print screen setting menu. You can set the image format to "BMP" or "PNG".

Then click or tap the **Print Screen** button at the bottom of the interface. The screen image will be stored in the specified format. By default, the screen capture is saved to internal memory.

## 17.6 Option

In **Utility** menu, click or tap **Options** to view the option installation information. To install options, please refer to *To View the Option Information and Install the Option*.

## 17.7 Open Source Acknowledgment

In the **Utility** menu, click or tap **Open Source** to view the open source acknowledgment of this series in the pop-up window.

## 17.8 Self-check

In **Utility** menu, click or tap **Self Check** to enter the "Self Check" menu. You can test the following self-check items for the device.

### Key Test

Click or tap **Key Test** to enter the key test interface (virtual front-panel key).

At this time, you can press the front-panel keys to check whether the virtual keys are highlighted. If yes, it indicates that the keys work normally; if no, it indicates that there's something wrong with the keys. Click or tap **Exit** at the lower-right corner of the interface to exit the key test interface.

### Touch Test

Click or tap **Touch Test** to enter the touch screen test interface.

Slide with your finger on the screen. If there is a line displaying at the empty area where you slide on the screen and the box that you tap turns out to be filled with green background, it indicates that the touch function of this area is normal. Click or tap **Exit** at the lower-left corner of the interface to exit the touch screen test interface.

### Screen Test

Click or tap **Screen Test** to enter the screen test interface and check whether the defective pixel exists.

There are 15 screen test interfaces. Click or tap the screen to switch to the next screen test interface. Click or tap **Exit** at the upper-left corner of the interface to exit the screen test interface.

## 18 Preset Function

DG5000 Pro provides one auto memory location (AUTO\_RECALL) and five user-defined state memory locations (STATE\_1 to STATE\_5). You can store the instrument states to the specified state memory locations and recall them when necessary. Stored states include channel parameters, waveform parameters, and system

parameters. Click or tap  > **Preset** to enter the "Preset" menu, as shown in the figure below.

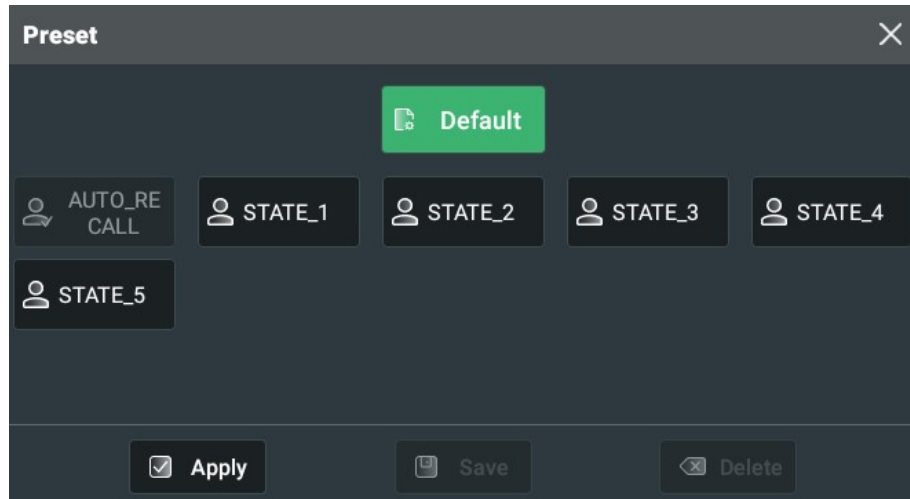

Figure 18.1 Preset Menu



### TIP

If *Load Last* is set to "Last", the instrument automatically recalls the system configurations at last power-down (stored in AUTO\_RECALL) when it is powered on. Also, the **AUTO\_RECALL** is grayed out and cannot be modified.

### Restore Default Settings

Click or tap **Default** > **Apply**. Then click or tap **OK** in the pop-up menu to reset the instrument to factory default settings. You can also press the front-panel **Default** key. For the factory default values, refer to *Table 18.1 Factory Settings*.

### Store Instrument States

Click or tap one state from **STATE\_1** to **STATE\_5**. Then click or tap **Save** to save the current system state to the specified location in the internal non-volatile memory. If *Load Last* is set to "Default", you can also store the system state to AUTO\_RECALL. If an existing state file has been stored, this operation overwrites the original file.

### Recall Instrument States

When a state file has been stored in the specified location, you can select the location and then click or tap **Apply** > **OK** to recall the state file.

## Delete State Files

When a state file has been stored in the specified location, you can select the location and then click or tap **Delete** > **OK** to delete the state file.

**Table 18.1 Factory Settings**

| Parameter                     | Factory Settings |
|-------------------------------|------------------|
| <b>Channel Output</b>         |                  |
| Basic Waveform                | Sine             |
| Output Mode                   | Continuous       |
| Frequency                     | 1 kHz            |
| Period                        | 1 ms             |
| Amplitude                     | 5 Vpp            |
| Offset                        | 0 Vdc            |
| Phase                         | 0°               |
| <b>Continuous</b>             |                  |
| Square Duty Cycle             | 50%              |
| Square Fast Transition On/Off | Off              |
| Square Transition Time        | 800 ps           |
| Ramp Symmetry                 | 50%              |
| Pulse Display Type            | Duty Cycle       |
| Pulse Duty Cycle              | 50%              |
| Pulse Width                   | 500 μs           |
| Pulse Leading Edge            | 1.4 ns           |
| Pulse Trailing Edge           | 1.4 ns           |
| Harmonic Type                 | Order            |
| Harmonic Order                | 2                |
| Harmonic Phase                | 0°               |
| Harmonic Amplitude            | 5 Vpp            |
| Arb Type                      | Sinc             |
| <b>Burst</b>                  |                  |
| State                         | Off              |
| Burst Type                    | N-Cycle          |
| Burst Period                  | 10 ms            |
| Trigger Source                | Internal         |
| Cycles                        | 1                |
| Phase                         | 0°               |
| Delay                         | 0 s              |
| Gated Polarity                | Positive         |
| Idle Level                    | 1st Pt           |

| Parameter              | Factory Settings |
|------------------------|------------------|
| <b>Modulation</b>      |                  |
| AM                     |                  |
| Modulation Source      | Internal         |
| Shape                  | Sine             |
| Modulation Frequency   | 100 Hz           |
| Modulation Depth       | 100%             |
| DSSC                   | OFF              |
| FM                     |                  |
| Modulation Source      | Internal         |
| Shape                  | Sine             |
| Modulation Frequency   | 100 Hz           |
| Frequency Deviation    | 100 Hz           |
| PM                     |                  |
| Modulation Source      | Internal         |
| Shape                  | Sine             |
| Modulation Frequency   | 100 Hz           |
| Phase Deviation        | 90°              |
| ASK                    |                  |
| Modulation Source      | Internal         |
| Polarity               | Positive         |
| Modulation Rate        | 100 Hz           |
| Modulation Amplitude   | 2 Vpp            |
| FSK                    |                  |
| Modulation Source      | Internal         |
| Polarity               | Positive         |
| Modulation Rate        | 100 Hz           |
| Hop Frequency          | 10 kHz           |
| PSK                    |                  |
| Modulation Source      | Internal         |
| Polarity               | Positive         |
| Modulation Rate        | 100 Hz           |
| Phase                  | 180°             |
| Pulse Width Modulation |                  |
| Modulation Source      | Internal         |
| Shape                  | Sine             |
| Modulation Frequency   | 100 Hz           |
| Duty Cycle Deviation   | 5%               |
| Width Deviation        | 50 μs            |
| SUM                    |                  |
| SUM Ratio              | 50%              |
| SUM Frequency          | 100 Hz           |

| Parameter             | Factory Settings |
|-----------------------|------------------|
| SUM Waveform          | Sine             |
| <b>Sweep</b>          |                  |
| Sweep Type            | Linear Sweep     |
| Trigger Source        | Internal         |
| Start Frequency       | 100 Hz           |
| Stop Frequency        | 1 kHz            |
| Center Frequency      | 550 Hz           |
| Frequency Span        | 900 Hz           |
| Sweep Time            | 1 s              |
| Return Time           | 0 s              |
| Start Hold Time       | 0 s              |
| Stop Hold Time        | 0 s              |
| <b>Advanced</b>       |                  |
| Advanced Waveform     | Arb              |
| Arb                   |                  |
| Sample Rate           | 1 MSa/s          |
| Filter Mode           | Normal           |
| Sequence              |                  |
| Sample Rate           | 1 MSa/s          |
| Filter Mode           | Normal           |
| Timer                 | 1 s              |
| External Trigger Mode | Leading Edge     |
| No. of Steps          | 1                |
| Waveform              | Sine             |
| Loop                  | 1                |
| Wait                  | Off              |
| Event Input           | Off              |
| Jump to               | Next             |
| Go To                 | Next             |
| PRBS                  |                  |
| Bit Rate              | 1 Mbps           |
| PRBS Type             | PRBS3            |
| Edge Time             | 2 ns             |
| Multi-pulse           |                  |
| Trigger Delay         | 500 ms           |
| Trigger Source        | Off              |
| Edge Time             | 2 ns             |
| Idle Level            | Middle           |
| SN                    | 1                |
| Pulse Count           | 2                |



| Parameter                 | Factory Settings |
|---------------------------|------------------|
| H-Width                   | 5 $\mu$ s        |
| L-Width                   | 5 $\mu$ s        |
| Multi-tone                |                  |
| Start Frequency           | 1 MHz            |
| Spacing                   | 1 MHz            |
| Tone Count                | 2                |
| Gain                      | 0 dB             |
| Phase                     | 0°               |
| Pattern                   |                  |
| Bit Rate                  | 9.6 kbps         |
| Preset Amplitude          | User             |
| Input Data Type           | Pattern          |
| Encoding Type             | NRZ              |
| Data Format               | Binary           |
| Data                      | 0                |
| IQ                        |                  |
| Center Frequency          | 100 MHz          |
| Power                     | 0 dBm            |
| Data Type                 | ALL1             |
| Data Length               | 10,000           |
| Symbol Rate               | 1 MSa/s          |
| Mod Type                  | BPSK             |
| Code Type                 | OFF              |
| Oversampling              | 4                |
| Filter Type               | Rectangular      |
| Alpha/BT                  | 0.25             |
| <b>Bundle By Source</b>   |                  |
| Benchmark Channel         | CH1              |
| Frequency Coupling        | Off              |
| Frequency Coupling Mode   | Offset           |
| Frequency Coupling Ratio  | 1                |
| Frequency Coupling Offset | 0 Hz             |
| Phase Coupling            | Off              |
| Phase Coupling Mode       | Offset           |
| Phase Coupling Ratio      | 1                |
| Phase Coupling Offset     | 0°               |
| Amplitude Coupling        | Off              |
| Amplitude Coupling Mode   | Offset           |
| Amplitude Coupling Ratio  | 1                |
| Amplitude Coupling Offset | 0 Vpp            |
| Track On/Off              | Off              |

| Parameter               | Factory Settings |
|-------------------------|------------------|
| <b>Channel Setup</b>    |                  |
| Sync On/Off             | Off              |
| Sync Mode               | Normal           |
| Sync Polarity           | Positive         |
| Mark Frequency          | 500 Hz           |
| Invert                  | OFF              |
| Impedance               | HighZ            |
| Trigger Output          | Off              |
| Trigger Output Polarity | Leading Edge     |
| <b>System Utility</b>   |                  |
| Beeper                  | On               |
| Clock Source            | Internal         |
| Print Screen Format     | PNG              |

## 19 Remote Control

The following ways of remote control are supported:

- **User-defined Programming**

Users can program and control the instrument by using the SCPI (Standard Commands for Programmable Instruments) commands. For details about the SCPI commands and programming, refer to *Programming Guide* of this product series.

- **PC Software**

You can use the PC software to send SCPI commands to control the instrument remotely. RIGOL Ultra Sigma is recommended. You can download the software from RIGOL official website (<http://www.rigol.com>).

**Operation Procedures:**

- Set up communication between the instrument and PC.
- Run Ultra Sigma and search for the instrument resource.
- Open the remote command control panel to send commands.

- **Web Control**

This instrument supports Web Control. You can view the display of the real-time interface of the instrument using Web Control. Through the Web Control method, you can migrate the device control to the control terminals (e.g. PC, Mobile, iPad, and other smart terminals) to realize remote control of the instrument. Connect the instrument to the network, then input the IP address of the instrument into the address bar of the browser of your computer. When mDNS is enabled, you can also input "hostname.local" (see *LX*) to use Web Control. You have to log in before using the Web Control to modify network settings. When you first log in to the Web Control, the user name is "admin" and password is "rigol".

This instrument can be connected to the PC via the USB and LAN interface to set up communication and realize remote control through the PC.

This chapter will illustrate how to use the RIGOL Ultra Sigma software to remotely control the instrument via various interfaces.



**CAUTION**

**Before connecting the communication cable, please turn off the instrument to avoid causing damage to the communication interfaces.**

## 19.1 Remote Control via USB

---

### 1. Connect the device

Use the USB cable to connect the rear-panel USB DEVICE interface of the instrument to the USB HOST interface of the PC.

### 2. Search for the device resource

Start up Ultra Sigma and the software will automatically search for the resource currently connected to the PC via the USB interface. You can also click **USB-TMC** to search for the resource.

### 3. View the device resource

The resources found will appear under the "RIGOL Online Resource" directory, and the model number and USB interface information of the instrument will also be displayed.

### 4. Control the instrument remotely

Right-click the device resource name and select "SCPI Panel Control" to open the remotely command control panel. Then you can send commands and read data through the panel. For details about the SCPI commands and programming, refer to the Programming Guide of this instrument.

## 19.2 Remote Control via LAN

---

### 1. Connect the device

Use the network cable to connect the instrument to your local area network (LAN).

### 2. Configure network parameters

Configure the network parameters of the instrument in **Utility>IO** menu.

### 3. Search for Search device resource

Start up Ultra Sigma and click **LAN** to open the panel as shown in the figure below. Click **Search** and the software searches for the instrument resources currently connected to the LAN and the resources found are displayed at the right section of the window as shown in the figure below. Click **OK** to add it.

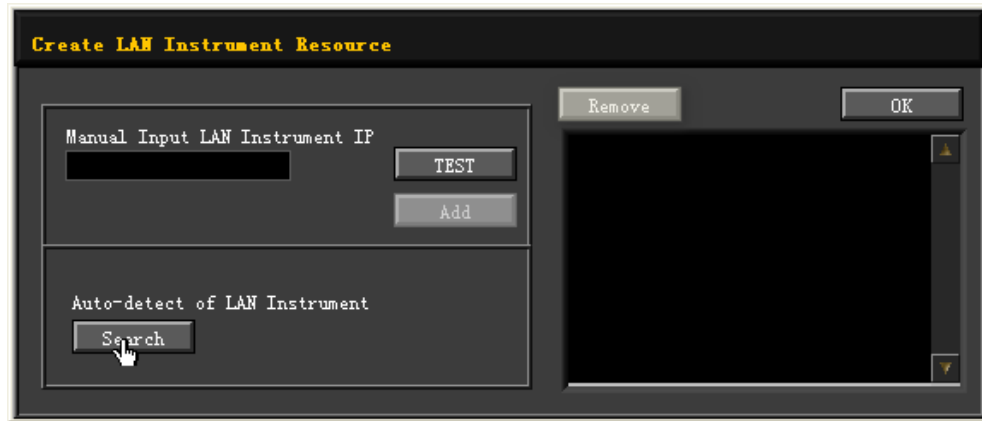

Besides, you can input the IP address of the instrument manually into the text field under "Manual Input LAN Instrument IP", then click **TEST**. If the instrument passes the test, click **Add** to add the instrument to the LAN instrument resource list in the right section; if the instrument fails the test, please check whether the IP address that you input is correct, or use the auto search method to add the instrument resource.

#### 4. View the device resource

The resources found will appear under the "RIGOL Online Resource" directory.

#### 5. Control the instrument remotely

Right-click the device resource name and select "SCPI Panel Control" to open the remotely command control panel. Then you can send commands and read data through the panel.

#### 6. Load LXI webpage

As this instrument conforms to LXI CORE 2011 DEVICE standards, you can load LXI web page through Ultra Sigma (right-click the instrument resource name and select "LXI-Web"). Various important information about the instrument (including the model, manufacturer, serial number, description, MAC address, and IP address) will be displayed on the web page. You can also directly input the IP address of the instrument in the address bar of the PC browser to load the LXI web page.

## 20 Troubleshooting

---

### **1. When I power on the instrument, the instrument stays black and does not display anything.**

- a. Check whether the power supply has been connected correctly.
- b. Check whether the power key is really pressed.
- c. Check whether the fuse is blown. If you need to replace the fuse, use only the specified fuse that conforms to the product.
- d. Restart the instrument after finishing the above inspections.
- e. If the problem still persists, please contact RIGOL.

### **2. The settings are correct but no waveform is generated.**

- a. Check whether the output cable is connected to the corresponding channel output terminal tightly.
- b. Check whether the output cable works properly.
- c. Check whether the output cable is connected to the test instrument tightly.
- d. If the problem still persists, please contact RIGOL.

### **3. The USB storage device cannot be recognized.**

- a. Check whether the USB storage device can work normally when connected to other instruments or PC.
- b. Make sure that the USB storage device is FAT32, NTFS, or exFAT type. The instrument doesn't support hardware USB storage device.
- c. After restarting the instrument, insert the USB storage device again to check whether it can work normally.
- d. If the USB storage device still cannot work normally, please contact RIGOL.

### **4. Performance verification test is failed.**

- a. Check whether the generator is within calibration period (1 year).
- b. Check whether the generator has been warmed up for at least 30 minutes before the test.
- c. Check whether the generator is under the specified temperature.
- d. Check whether the test is under strong-magnetism environment.
- e. Check whether the power supplies of the generator and test system have a strong interference.

- f. Check whether the performance of the test device used meets the requirement.
  - g. Make sure that the test device used is within the calibration period.
  - h. Check whether the test device used meets the required conditions of the manual.
  - i. Check whether all the connections are tight.
  - j. Check whether any cable has internal damage.
  - k. Make sure that the operations conform to settings and processes which are required by the performance verification manual.
  - l. Check whether the error calculation has faults.
  - m. Correctly understand the definition of "typical value" for this product: the performance specification of this product under specified conditions.
- 5. The touch-enabled operation does not work.**
- a. Check whether you have locked the touch screen. If yes, unlock the touch screen.
  - b. Check whether the screen or your finger is stained with oil or sweat. If yes, please clean the screen or dry your hands.
  - c. Check whether there is a strong magnetic field around the instrument. If the instrument is close to the strong magnetic field (e.g. a magnet), please move the instrument away from the magnet field.
  - d. If the problem still persists, please contact RIGOL.

## 21 Appendix

### 21.1 Appendix A: Options and Accessories

| Order Information                                                | Order No.           |
|------------------------------------------------------------------|---------------------|
| <b>Model</b>                                                     |                     |
| 250 MHz Bandwidth, 2.5 GSa/s Sample Rate, Dual-channel           | DG5252 Pro          |
| 250 MHz Bandwidth, 2.5 GSa/s Sample Rate, Four-channel           | DG5254 Pro          |
| 250 MHz Bandwidth, 2.5 GSa/s Sample Rate, Eight-channel          | DG5258 Pro          |
| 350 MHz Bandwidth, 2.5 GSa/s Sample Rate, Dual-channel           | DG5352 Pro          |
| 350 MHz Bandwidth, 2.5 GSa/s Sample Rate, Four-channel           | DG5354 Pro          |
| 350 MHz Bandwidth, 2.5 GSa/s Sample Rate, Eight-channel          | DG5358 Pro          |
| 500 MHz Bandwidth, 2.5 GSa/s Sample Rate, Dual-channel           | DG5502 Pro          |
| 500 MHz Bandwidth, 2.5 GSa/s Sample Rate, Four-channel           | DG5504 Pro          |
| 500 MHz Bandwidth, 2.5 GSa/s Sample Rate, Eight-channel          | DG5508 Pro          |
| <b>Standard Accessories</b>                                      |                     |
| Power Cord Conforming to the Standard of the Destination Country | — —                 |
| SMB Pin Insertion/extraction Tool                                | — —                 |
| USB Cable                                                        | CB-USBA-USBB-FF-150 |
| 2/4/8 BNC Cables                                                 | CB-BNC-BNC-MM-100   |



| Order Information                                                      | Order No.         |
|------------------------------------------------------------------------|-------------------|
| <b>Options</b>                                                         |                   |
| IQ Modulation Option                                                   | DG5000 Pro-IQ     |
| Multi-pulse Output Option                                              | DG5000 Pro-MPUL   |
| Advanced Sequence Function                                             | DG5000 Pro-SEQ    |
| Multi-tone Option                                                      | DG5000 Pro-MTONE  |
| Pattern Option                                                         | DG5000 Pro-PJ     |
| 128 Mpts/CH (Max.) Arb Length Upgrade Option                           | DG5000 Pro-2RL    |
| Function Bundle Option<br>DG5000 Pro-IQ/MPUL/SEQ/MTONE/PJ/2RL included | DG5000 Pro-BND    |
| <b>Optional Accessories</b>                                            |                   |
| 40dB Attenuator (50 $\Omega$ , 1 W)                                    | RA5040K           |
| SMB(F) to SMB(F) Cable (1 m)                                           | CB-SMB-SMB-FF-100 |
| SMB(F) to BNC(F) Cable (1 m)                                           | CB-SMB-BNC-FF-100 |
| SMB(F) to BNC(M) Cable (1 m)                                           | CB-SMB-BNC-FM-100 |
| BNC to Alligator Clip Cable                                            | CB-BNC-AC-100-L   |

## 21.2 Appendix B: Warranty

RIGOL TECHNOLOGIES CO., LTD. (hereinafter referred to as RIGOL) warrants that the product mainframe and product accessories will be free from defects in materials and workmanship within the warranty period. If a product proves defective within the warranty period, RIGOL guarantees free replacement or repair for the defective product.

To get repair service, please contact your nearest RIGOL sales or service office.

There is no other warranty, expressed or implied, except such as is expressly set forth herein or other applicable warranty card. There is no implied warranty of merchantability or fitness for a particular purpose. Under no circumstances shall RIGOL be liable for any consequential, indirect, ensuing, or special damages for any breach of warranty in any case.

# Boost Smart World and Technology Innovation

Industrial Intelligent  
Manufacturing



Semiconductors

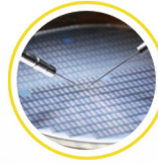

Education &  
Research

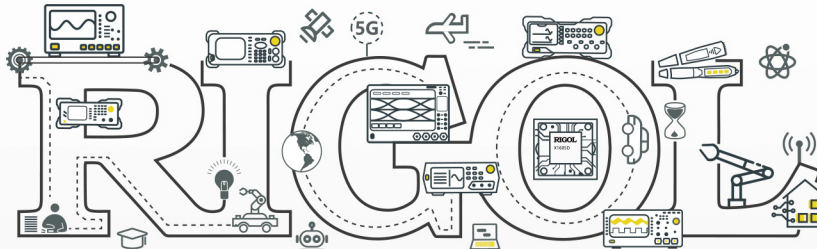

Communication

System Integration

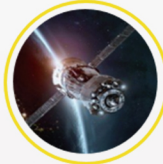

New Energy



- 5G Cellular-5G/WIFI
- UWB/RFID/ ZIGBEE
- Digital Bus/Ethernet
- Optical Communication

- Digital/Analog/RF Chip
- Memory and MCU Chip
- Third-Generation Semiconductor
- Solar Photovoltaic Cells

- New Energy Automobile
- PV/Inverter
- Power Test
- Automotive Electronics

*Provide Testing and Measuring Products  
and Solutions for Industry Customers*

## HEADQUARTER

**RIGOL TECHNOLOGIES CO., LTD.**  
No.8 Keling Road, New District,  
Suzhou, JiangSu, P.R.China  
Tel: +86-400620002  
Email: info-cn@rigol.com

## JAPAN

**RIGOL JAPAN CO., LTD.**  
5F, 3-45-6, Minamiotsuka, Toshima-Ku,  
Tokyo, 170-0005, Japan  
Tel: +81-3-6262-8932  
Fax: +81-3-6262-8933  
Email: info.jp@rigol.com

## EUROPE

**RIGOL TECHNOLOGIES EU GmbH**  
Carl-Benz-Str.11  
82205 Gilching  
Germany  
Tel: +49(0)8105-27292-0  
Email: info-europe@rigol.com

## KOREA

**RIGOL KOREA CO., LTD.**  
5F, 222, Gonghang-daero,  
Gangseo-gu, Seoul, Republic of Korea  
Tel: +82-2-6953-4466  
Fax: +82-2-6953-4422  
Email: info.kr@rigol.com

## NORTH AMERICA

**RIGOL TECHNOLOGIES, USA INC.**  
10220 SW Nimbus Ave.  
Suite K-7  
Portland, OR 97223  
Tel: +1-877-4-RIGOL-1  
Email: sales@rigol.com

## For Assistance in Other Countries

Email: info.int@rigol.com