



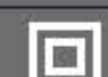

Table of Contents

Safety Information	-----	1
Safety Symbols	-----	1
Warning	-----	1
Maintenance	-----	2
Introduction	-----	3
Description	-----	3
Panel Description	-----	5
Operation	-----	6
Accuracy Specification	-----	10
General Specifications	-----	14
Auto power off	-----	15
Replace battery	-----	15
Accessory	-----	15

Safety Information

This meter is designed and manufactured according to the safety requirements set out by the IEC61010-1 standards for electronic test instruments and the hand-hold digital multimeters. Its design and manufacture is strictly based on the provisions in the CAT III 600V of IEC61010-1 and the Stipulation of 2-Pollution Grade.

Safety Symbols

	Risk of danger. Important information. See manual.
	Hazardous voltage.
	Application around and removal from Hazardous Live conductors is permitted.
	Double insulated((Protection class II))
	Earth ground

warning

- ⇒ To avoid possible electric shock, personal injury, or death, read the following before using the Meter:
- ⇒ Use the test leads supplied to ensure operation safety. If required, they must be replaced with test leads of the same model or class.
- ⇒ Inspect the test leads before use. Do not use them if insulation is damaged or metal is exposed. Check the test leads for continuity. Replace damaged test leads before using, Do not use the Meter if it appears damaged.
- ⇒ Do not touch the metal tips of the test leads when the meter is connected to the circuit to be measured.

- ⇒ When Voltage > 60 V dc or ac peak .keep your fingers behind the finger guards.
- ⇒ Verify the Meter's operation by measuring a known voltage before and after using it. Do not use the Meter if it operates abnormally. Select the highest range if the value scale to be measured in the manual range is unknown.
- ⇒ Do not take voltage measurement if the value between the terminals and earth ground exceeds 600V.
- ⇒ Disconnect the test leads from the circuit under test before turning the rotary selector to change functions.
- ⇒ Disconnect circuit power and discharge all high voltage capacitors before testing resistance, continuity, diodes, or capacitor.
- ⇒ Do not store or use the meter in areas exposed to direct sunlight, at high temperature or with high relative humidity.
- ⇒ Do not touch live circuit or exposed metal

MAINTENANCE

- ⇒ Before opening the rear of the meter, disconnect test leads from all sources of electric current.
- ⇒ Use damp cloth and mild detergent to clean the meter; do not use abrasives or solvents.
- ⇒ Whenever it is likely that safety protection has been impaired, make the Meter inoperative and secure it against any unintended operation.
- ⇒ Have the Meter serviced only by qualified service personnel

Introduction

This meter 3 3/4 digits with steady operations, fashionable structure and highly reliable measuring instrument. The Meter uses large scale of integrated circuit with double integrated A/D converter as its core and has full range overload protection.

The meter can perform measurements of AC current, AC/DC voltage, resistance, capacitance as well as continuity and diode test.

Description**1. Transformer Jaws**

Designed to pick up the AC current flowing through the conductor.

2. Hand Guards

To protect user's hand from touching the dangerous area.

3. Rotary Switch

Select proper Range and function.

4. HOLD button

Press 'hold' button the meter stop updating the LCD panel. LCD display "", press the button again, the meter exit hold mode

5. RAN auto/manual Range button

Under Voltage, resistance measurement mode, the default mode is autorange, press RAN button switch to manual range; while in manual range mode changes the full-scale range, press this button more than 2 seconds, the meter switch to autorange.

6. LCD Screen

Max Display 3999

7. INPUT Terminals

Input positive terminals for all measurement except current measurement, connected with red test leads.

8. COM Terminals

Input common terminals for all measurement except current measurement, connected with black test leads.

9. Hz% Frequency and duty Switch Button

Under AC voltage measurement, press Hz% button to Select a function from voltage, frequency to duty.

10. SEL :Function selecting button

In voltage mode, press SEL button to toggle from DCV to ACV; in  mode, it is used to select a function from resistance, capacitance, Diode to continuity.

11. Back light

Press the "" button more than two seconds to turn on the back light, press again to turn it off.

12. Trigger

press the lever to open the transformer jaws. When the pressure on the lever is released, the jaws will close.

13. Transformer Jaws Lighting Bulb

Switch rotary switch to current position, then turn on lighting Bulb and back light.

Panel Description

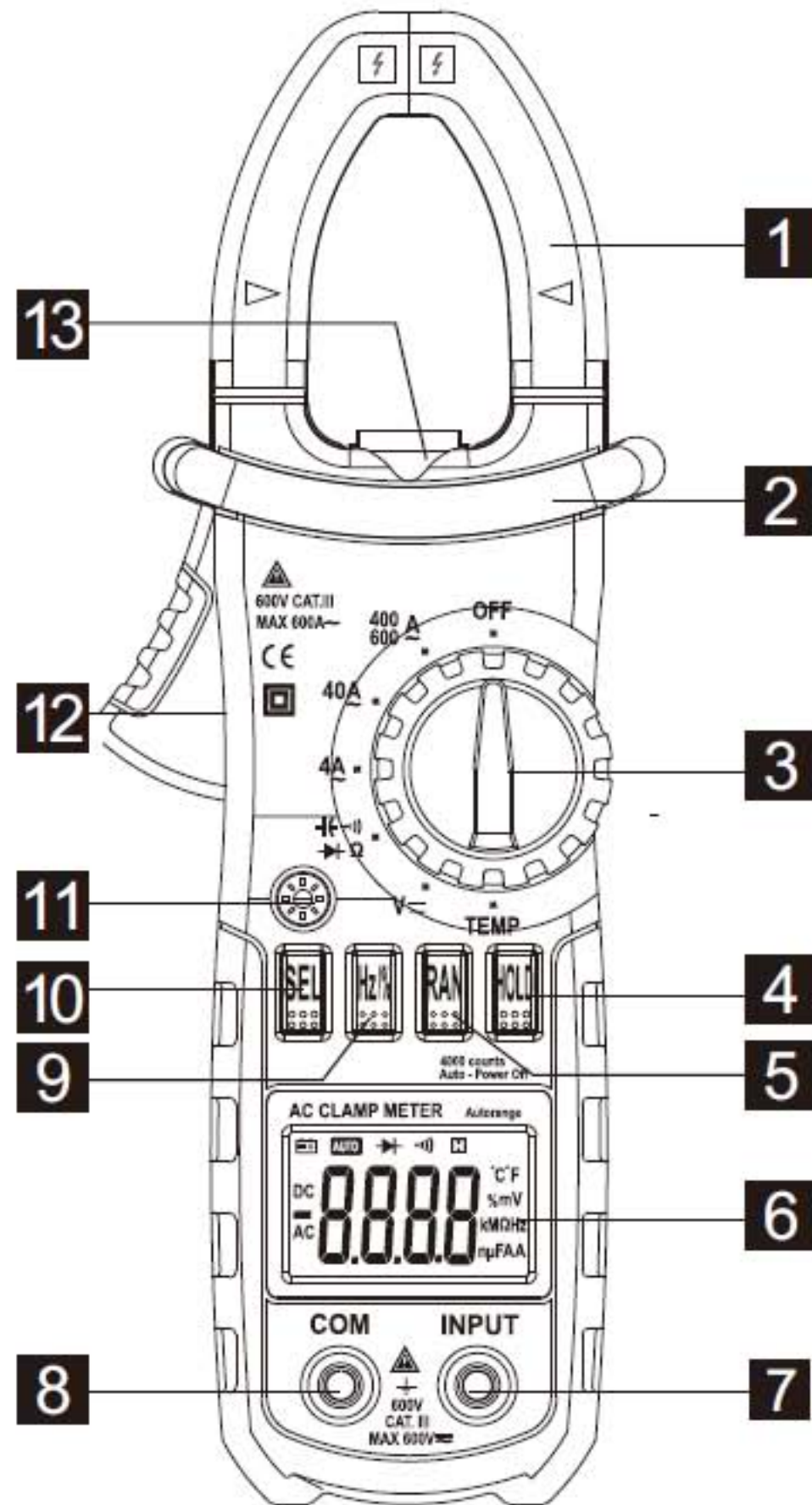

Measurement Operation

DC Voltage Measurement

1. Plug the black test lead into the COM terminals and the red test lead into the INPUT terminals
2. Set the rotary switch to V \approx , press SEL button switch to DC voltage, Connect the test leads across with the object being measured..
3. The measured value shows on the display

Warning



- △ Select the highest range if the value scale to be measured in the manual range is unknown
- △ To avoid harms to you or damages to the Meter from electric shock

AC Voltage Measurement

1. Plug the black test lead into the COM terminals and the red test lead into the INPUT terminals
2. Set the rotary switch to V \approx , press SEL button switch to AC voltage, Connect the test leads across with the object being measured..
3. The measured value shows on the display

Warning



- △ To avoid harms to you or damages to the Meter from electric shock

AC Current Measurement

1. Set the rotary switch to proper current range.
2. Press the lever to open the transformer jaws, center the conductor within the transformer jaw. Please only measure one conductor each time.
3. The measured value shows on the display.

Warning



- △ Select the highest range if the value scale to be measured is unknown, then adjust the rotary switch until get satisfactory resolution.
- △ To avoid harms to you or damages to the Meter when measuring exposed conductor.

Measuring Resistance

1. Plug the black test lead into the COM terminals and the red test lead into the INPUT terminals
2. Set the rotary switch to $\frac{1}{\Omega}$, press SEL button switch to Ω , Connect the test leads across with the object being measured.
3. The measured value shows on the display

Warning



- △ At the manual range mode, when only "OL" is shown on the LCD, it means the measurement has exceeded the range. A higher range should be selected.
- △ When measuring in-circuit resistance, make sure that the power of the circuit under test has been turned off and that all capacitors have been fully discharged.

Measuring Diode

1. Plug the black test lead into the COM terminals and the red test lead into the INPUT terminals
2. Set the rotary switch to $\frac{1}{\Omega}$, press SEL button switch to \rightarrow , Connect the test leads across with the object being measured (Connect the red test lead to the anode and the black test lead to the cathode of the diode).
3. The Measured value shows on the display

Testing for Continuity

1. Plug the black test lead into the COM terminals and the red test lead into the INPUT terminals
2. Set the rotary switch to $\frac{1}{\Omega}$, press SEL button switch to \rightarrow , Connect the test leads across with the object being measured.
3. The buzzer sounds if the resistance of a circuit under test is less than 60Ω . The buzzer may or may not sounds if the resistance of a circuit under test is between 60Ω to 120Ω . The buzzer does not sound if the resistance of a circuit under test is higher than 120Ω .

Measuring Capacitance

1. Plug the black test lead into the COM terminals and the red test lead into the INPUT terminals
2. Set the rotary switch to $\frac{1}{\Omega}$, press SEL button switch to \rightarrow , Connect the test leads across with the object being measured.
3. The Measured value shows on the display

Warning



- △ When LCD display "OL" select higher range to measure
- △ When measuring in-circuit capacitance, make sure that the power of the circuit under test has been turned off and that all capacitors have been fully discharged.

Measuring temperature

1. Set the rotary switch to °C .
2. LCD Display Ambient temperature.
3. if required ,plug thermocouple's (K TYPE) red terminal into INPUT terminal and black terminal into COM terminal, measure object surface or around temperature with thermocouple's probe
4. The Measured value shows on the display.

Measuring frequency duty

1. Plug the black test lead into the COM terminals and the red test lead into the INPUT terminals
2. Set the rotary switch to V , press Hz% button switch to Hz or DUTY mode. Connect the test leads across with the object being measured.
3. The Measured value shows on the display

Accurate Specifications

- Accuracy: (a% reading + b digits), guarantee for 1 year
- Operating temperature: 18°C~28°C
- Relative humidity: 75%R.H
- Temperature coefficient: 0.1x(specified accuracy)/1°C

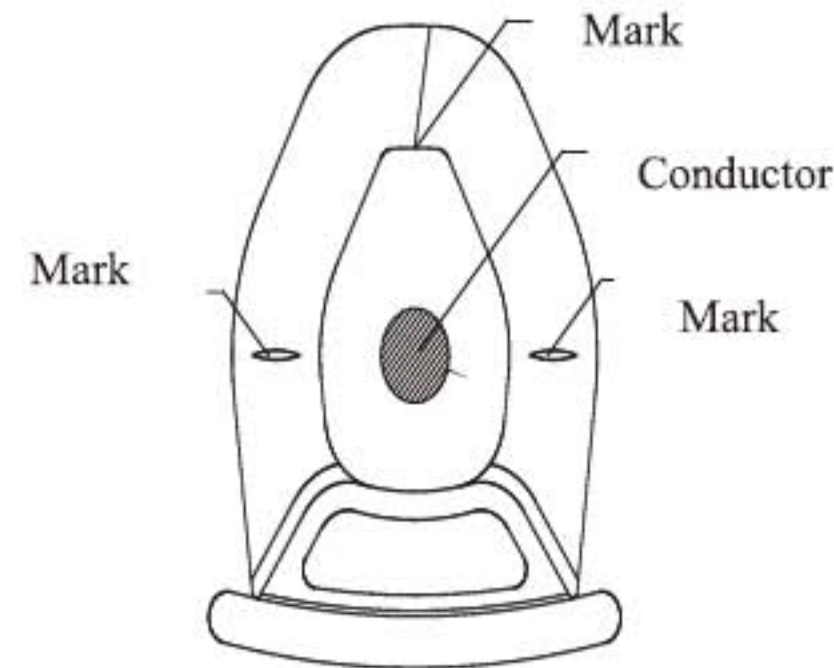

center the conductor within the transformer jaw, else may cause 1.5% position error in AC current mode

DC Voltage

Range	Resolution	Accuracy
400mV	0.1mV	± (0.8% reading + 2digits)
4V	1mV	
40V	10mV	
400V	0.1V	
600V	1V	± (1.0% reading +2 digits)

Input impedance : 10MΩ.

Max input Voltage : 600V DC or 600V AC Peak.

AC Voltage

Range	Resolution	Accuracy
400mv	0.1mV	± (1.0% reading + 10digits)
4V	1mV	
40V	10mV	
400V	0.1V	
600V	1V	± (1.2% reading + 10digits)

Input impedance : 10MΩ.

Frequency response : 40Hz~400Hz

Max input Voltage : 600V DC or 600V AC Peak.

AC Current

Range	Resolution	Accuracy
4A	0.001A	± (3.5% reading + 20digits) ≤0.5A
		± (3.0% reading +10 digits)
40A	0.01A	± (3.0 % reading +10 digits) ≤5A
		± (2.5% reading + 10 digits)
400A	0.1A	± (2.5% reading + 10 digits)
600A	1A	± (3.0% reading + 5 digits)

Frequency response : 50Hz~60Hz

Max Input Current: Full Range×120% and measuring time less than 60 seconds .

Resistance

Range	Resolution	Accuracy
400Ω	0.1Ω	±(1.2% reading+ 2digits)
4kΩ	0.001kΩ	
40kΩ	0.01kΩ	
400kΩ	0.1kΩ	
4MΩ	0.001MΩ	
40MΩ	0.01MΩ	±(2.0%reading+ 5digits)

Overloading protection: 600V DC or 600V AC peak

Diode

Range	Resolution	Accuracy
	1mV	Display forward Voltage (Open circuit voltage approximate 1.5V)

Overloading protection: 600V DC or 600V AC peak

continuity

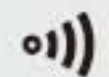
Range	Resolution	Accuracy
	100mΩ	Less than about ≤60Ω will beep (Open circuit voltage approximate 0.45V)

(warning :The buzzer may or may not sounds if the resistance of a circuit under test is between 60 Ω to 120 Ω, The buzzer does not sound if the resistance of a circuit under test is higher than 120Ω.)

Overloading protection: 600V DC or 600V AC peak

Capacitance

Range	Resolution	Accuracy
50nF	10pF	<10nF:±[5.0% of(reading -50 digits)+10 digits]± (3.0% reading +10 digits)
500nF	100pF	± (3.0% reading+ 5digits)
5µF	1nF	
50µF	10nF	
100µF	100nF	

Overloading protection: 600V DC or 600V AC peak

Frequency

Range	Resolution	Accuracy
50.00Hz	0.01Hz	± (0.1% reading+ 3digits)
500.0Hz	0.1Hz	
5.000kHz	0.001kHz	
50kHz	0.01kHz	
100kHz	0.1kHz	

Overloading protection: 600V DC or 600V AC peak

Duty

Range	Resolution	Accuracy
0.1-99.9%	0.1%	± 3.0%



Overloading protection: 600V DC or 600V AC peak

Temperature

Range	Resolution	Accuracy
-20°C~400°C	0.1°C	± (2.0% reading +2°C)
401°C~1000°C	1°C	±2.0% reading

Overloading protection: 600V DC or 600V AC peak

General Specifications

- Maximum voltage including transient overvoltage between any terminals and grounding: CATIII 600VDC or 600V AC peak
- Display : LCD screen, max reading 3999
- Measurement principle: double integrated A/D converter
- Range mode: Auto Range or manual Range
- Measurement Speed: (2.5~3 times) / Second
- Unit display: Sign
- Polarity Display: —
- Overloading: 'OL'
- HOLD : Display "  "
- Low Battery indication: Display'  '
- Power supply: DC1.5V X3 SIZE AAA battery.
- Dimensions : 208mm×78mm×35mm
- weight: <340g (including Battery)
- Max. Jaw Size: 26mm diameter
- Operating: 5°C~35°C
- Storage: -10°C~50°C

Auto power off

To preserve battery life, the Meter automatically turns off if you do not turn the rotary switch or press any button for around 15 minutes. The Meter can be activated by pressing SEL button

Replace battery

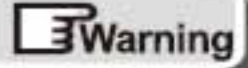

To avoid possible electric shock, Disconnect the test leads from the circuit under test before replace battery. Replace the same battery

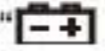
Make sure the transformer jaw and the test leads are disconnected from the circuit being tested before opening the case bottom. Check battery has been installed and battery cover been screwed before use . replace the battery as soon as the battery indicator " " appears.

Performs replace battery

- ① Disconnect test leads from live circuit, switch rotary switch to "OFF" position .
- ② Remove test leads from input terminals
- ③ Remove the screw from the battery cover, and separate the battery compartment from the case bottom. Replace the battery with 3pcs of new 1.5V (AAA) battery.
- ④ Rejoin the case bottom and the battery cover, and reinstall the screw.

Accessory

- manual 1
- Test leads 2
- Box 1
- "K" type thermocouple 1
- 1.5V SIZE AAA Battery 3