

# USERS MANUAL

## DIGITAL INSULATION TESTER

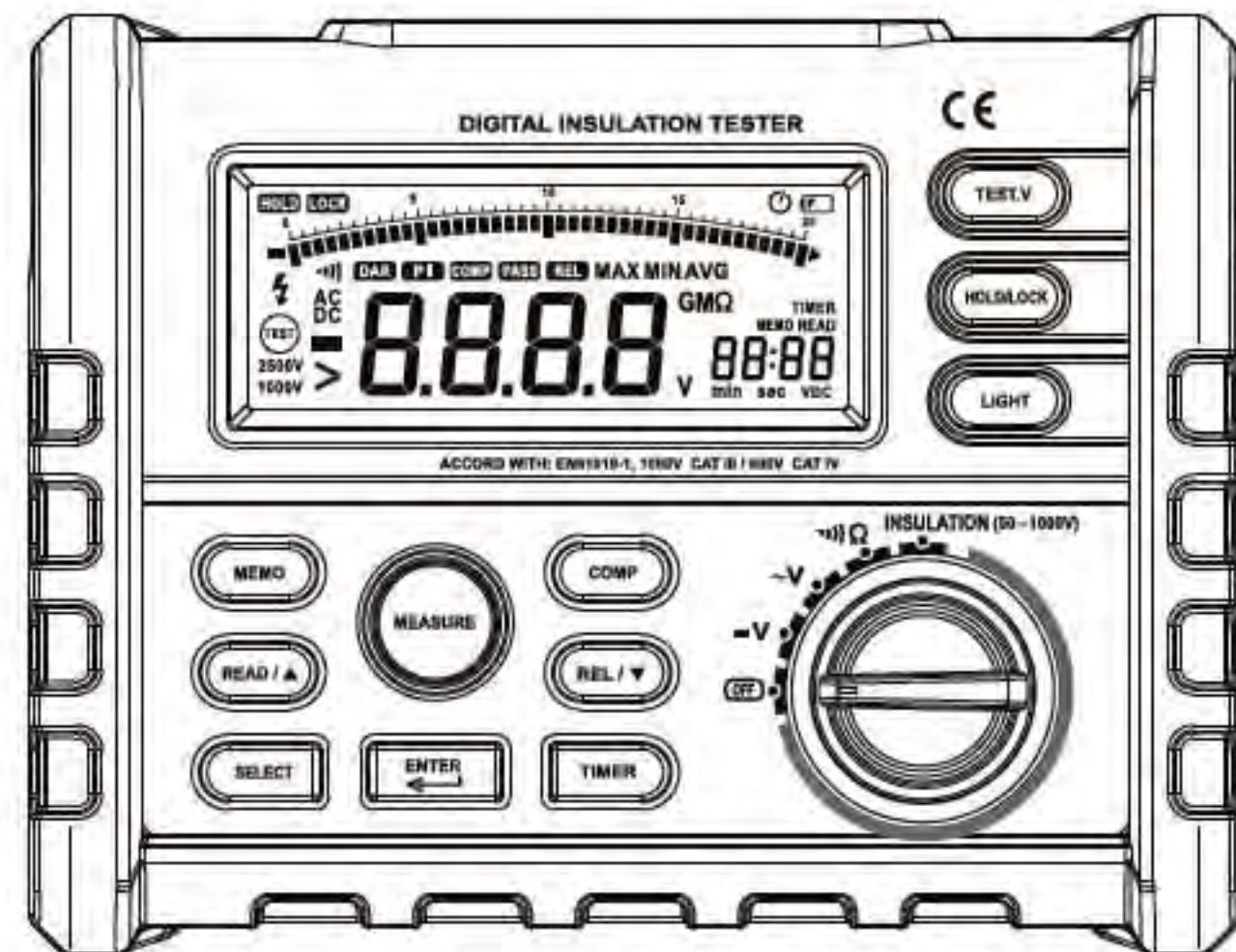

EMC&LVD

Designed and Certified to  
IEC61010-1  
CAT III 1000V



Designed and Certified to  
IEC61010-1  
CAT III 1000V

 Before using the instrument, please read this manual carefully, and save it well for future using.



**Table of Contents**

1. Safety Information..... 1

    1.1 Warning ..... 1

    1.2 Warranty..... 1

    1.3 Accessories..... 2

2. Introduction..... 2

    2.1 Front Panel ..... 2

    2.2 Display Screen..... 3

    2.3 Display Messages..... 6

    2.4 Buttons..... 7

    2.5 Rotary switch ..... 8

    2.6 Input Terminal ..... 9

3. Function Description ..... 9

    3.1 Power-Up Options ..... 9

    3.2 Automatic Power Off ..... 9

    3.3 Hold Funcion ..... 9

    3.4 Relative Measurement..... 9

    3.5 Insulation Test Lock..... 10

    3.6 Storing Test Data ..... 11

    3.7 Reading Test Data ..... 12

    3.8 Delete Data..... 12

    3.9 Compare Function ..... 13



3.10 Timer Function.....	15
3.11 MAX/ MIN/AVG.....	17
3.12 DAR & PI.....	17
4. Making Basic Measurements.....	18
4.1 Measuring DC Voltage .....	18
4.2 Measuring AC Voltage.....	19
4.3 Measuring Resistance.....	20
4.4 Insulation Test .....	20
5. Replacing battery.....	22
6. Specifications .....	23
7 Accuracy.....	24
7.1 DCV .....	24
7.2 ACV .....	24
7.3 Resistance .....	24
7.4 Insulation .....	25



## 1. Safety Information

This style of digital multimeter is designed and manufactured according to the safety requirements set out by the IEC61010-1 standards for electronic test instruments . Its design and manufacture is strictly based on the provisions in the 1000V CAT III of IEC61010-1 and the Stipulation of 2-Pollution Grade.

### 1.1 Warning

To avoid possible electric shock or personal injury, follow these guidelines:

- ⇒ Use the Meter only as specified in this manual or the protection provided by the Meter might be impaired.
- ⇒ Do not use the Meter or test leads if they appear damaged, or if the Meter is not operating properly. If in doubt, have the Meter serviced.
- ⇒ Always use the proper terminal, switch position, and range for measurements before connecting Meter to circuit under test.
- ⇒ Verify the Meter' s operation by measuring a known voltage.
- ⇒ Do not apply more than the rated voltage as marked on the Meter, between the terminals or between any terminal and earth ground.
- ⇒ Use caution with voltages above 30 V ac rms, 42 V ac peak, or 60 V dc. These voltages pose a shock hazard.
- ⇒ Replace the battery as soon as the low battery indicator (  ) appears.
- ⇒ Disconnect circuit power and discharge all high-voltage capacitors before testing resistance, continuity, diodes, or capacitance.
- ⇒ Do not use the Meter around explosive gas or vapor.
- ⇒ When using the test leads, keep your fingers behind the finger guards.
- ⇒ Remove test leads from the Meter before opening the Meter case or battery door.
- ⇒ Never operate the Meter with the cover removed or the battery door open.
- ⇒ Comply with local and national safety requirements when working in hazardous locations.
- ⇒ Use proper protective equipment, as required by local or national authorities when working in hazardous areas.
- ⇒ Use only the replacement fuse specified or the protection may be impaired.

### 1.2 Warranty

The meter is warranted to be free from defects in material and workmanship under normal use and service. The warranty period is one year and begins on the date of shipment. Parts, product repairs, and services are warranted for 12 months except for misused, altered, neglected, contaminated, or damaged by accident or abnormal conditions of operation or handling. This warranty does not apply to fuses, disposable batteries.



## 1. Safety Information

This style of digital multimeter is designed and manufactured according to the safety requirements set out by the IEC61010-1 standards for electronic test instruments . Its design and manufacture is strictly based on the provisions in the 1000V CAT III of IEC61010-1 and the Stipulation of 2-Pollution Grade.

### 1.1 Warning

To avoid possible electric shock or personal injury, follow these guidelines:

- ⇒ Use the Meter only as specified in this manual or the protection provided by the Meter might be impaired.
- ⇒ Do not use the Meter or test leads if they appear damaged, or if the Meter is not operating properly. If in doubt, have the Meter serviced.
- ⇒ Always use the proper terminal, switch position, and range for measurements before connecting Meter to circuit under test.
- ⇒ Verify the Meter' s operation by measuring a known voltage.
- ⇒ Do not apply more than the rated voltage as marked on the Meter, between the terminals or between any terminal and earth ground.
- ⇒ Use caution with voltages above 30 V ac rms, 42 V ac peak, or 60 V dc. These voltages pose a shock hazard.
- ⇒ Replace the battery as soon as the low battery indicator (  ) appears.
- ⇒ Disconnect circuit power and discharge all high-voltage capacitors before testing resistance, continuity, diodes, or capacitance.
- ⇒ Do not use the Meter around explosive gas or vapor.
- ⇒ When using the test leads, keep your fingers behind the finger guards.
- ⇒ Remove test leads from the Meter before opening the Meter case or battery door.
- ⇒ Never operate the Meter with the cover removed or the battery door open.
- ⇒ Comply with local and national safety requirements when working in hazardous locations.
- ⇒ Use proper protective equipment, as required by local or national authorities when working in hazardous areas.
- ⇒ Use only the replacement fuse specified or the protection may be impaired.

### 1.2 Warranty

The meter is warranted to be free from defects in material and workmanship under normal use and service. The warranty period is one year and begins on the date of shipment. Parts, product repairs, and services are warranted for 12 months except for misused, altered, neglected, contaminated, or damaged by accident or abnormal conditions of operation or handling. This warranty does not apply to fuses, disposable batteries.



### 1.3 Accessories

Item	Test Leads	Clips	Battery AA LR6	Manual
Quantity	2	2	6	1

## 2. Introduction

### 2.1 Front Panel

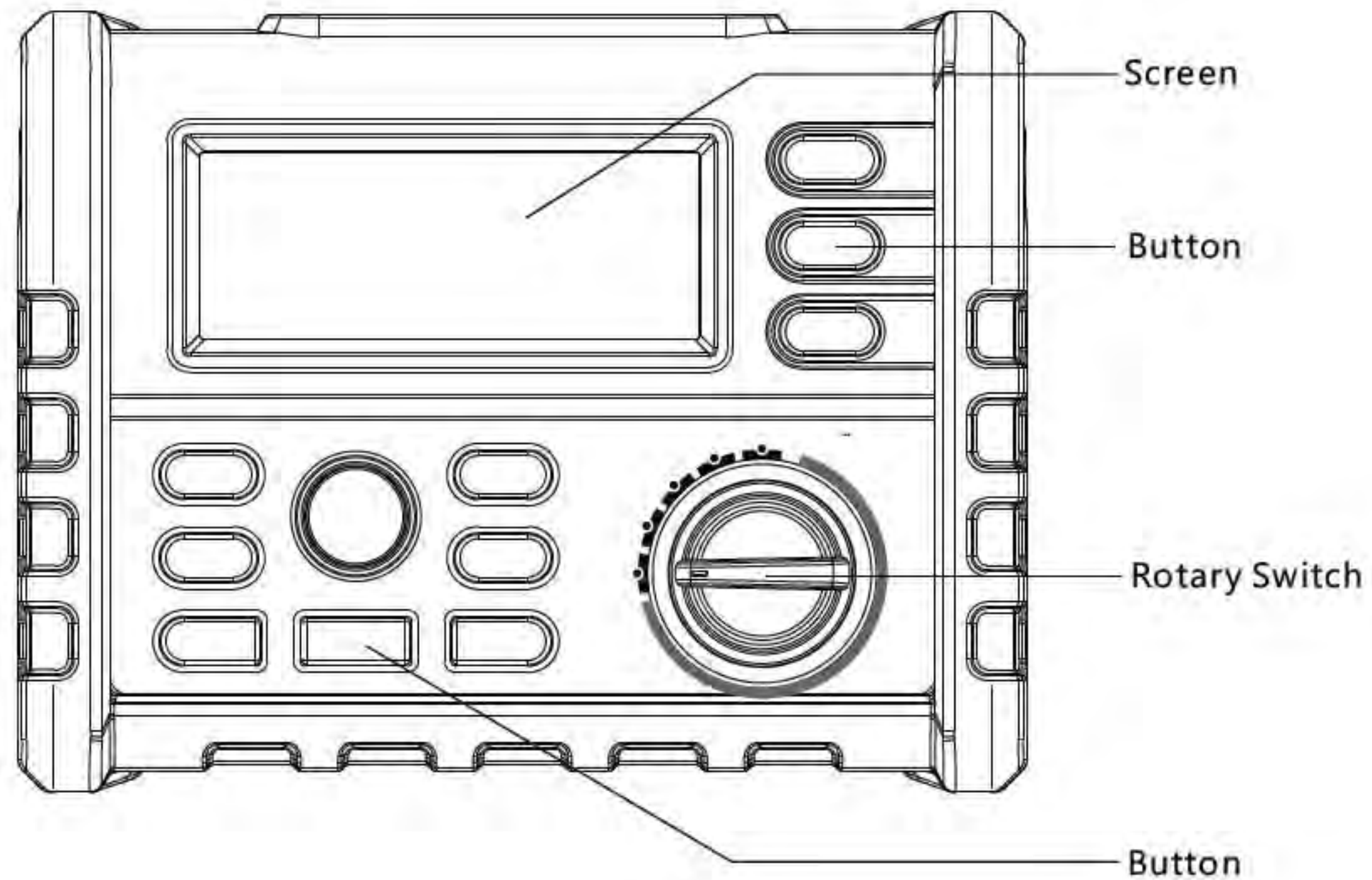



## 2.2 Display Screen

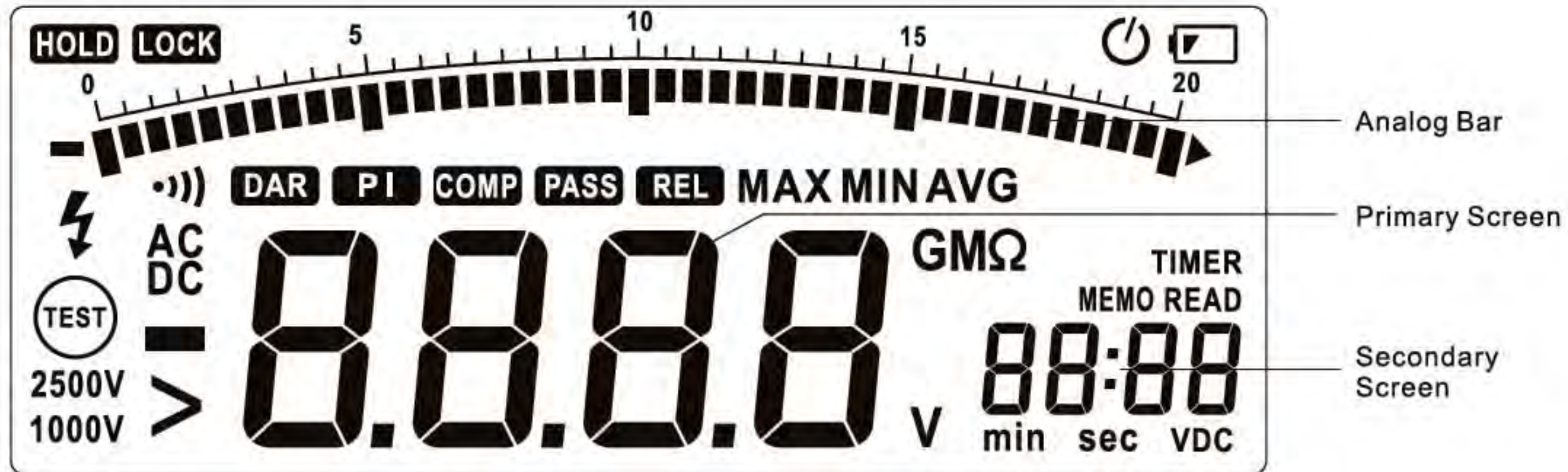



Indicator	Description
	Low battery Indicates when it is time to replace the battery. To avoid false readings, which could lead to possible electric shock or personal injury, replace the battery as soon as the low battery indicator appears.
<b>LOCK</b>	Indicates a test lock will be applied the next time you press Test Button on the meter, the test lock acts to hold down the button until you press Test Button again.
<b>HOLD</b>	Hold function ,the meter do not update display.
<b>COMP</b>	Compare function is selected



Indicator	Description
<b>PASS</b>	When compare function is selected,when the measuring value between upper limited value and lower limited value ,display this sign.
<b>REL</b>	Compare function is selected
<b>DAR</b>	In insulation test mode, display the DAR value
<b>PI</b>	In insulation test mode, display the PI value
<b>TIMER</b>	Timer function is selected
<b>MEMO</b>	Store function is selected
<b>READ</b>	View the memory data,when the data is invalid,display---
<b>DC</b>	DC Voltage function is selected
<b>AC</b>	AC Voltage function is selected
<b>VDC</b>	In insulation test mode ,test voltage unit
<b>—</b>	Minus, When the measure value lower than 0,display the sign.
<b>&gt;</b>	Greater symbols , In insulation test mode, indicates the measure value overflow.
<b>⚡</b>	Unsafe voltage warning , In insulation mode,indicates greater 20V voltage is detected on the input terminals.

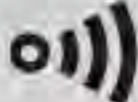

Indicator	Description
	Continuity test function is selected
	Auto power off function is selected
	Insulation test Indicator.when the rotary switch at insulation position, this sign appers,when the test voltage is present ,the sign alternate on or off
2500V 1000V	Source voltage rating for insulation test
min sec	Timer unit
GMΩV	Measure unit
MAX MIN AVG	Display the Max,Min Avg value



## 2.3 Display Messages

Indicator	Description
<b>batt</b>	Appears on primary display Indicates the battery too low for reliable operation, please replace battery.
<b>bat</b>	Appears on Auxiliary display , Indicates the battery too low to perform Insulation test
<b>P r E S</b>	Preset value
<b>POFF</b>	Auto power off function is disabled
<b>LIVE</b>	In insulation mode, indicates meter have detected the voltage on the input terminals
<b>DISC</b>	In insulation mode, indicates the meter performs the auto discharge function., not to touch any input terminals in this mode.
<b>SAVE</b>	Store measuring data
<b>dEL n:</b>	Delete the selected data
<b>dEL ALL</b>	Delete all memorized data
<b>COMP Hi</b>	The upper limited value
<b>COMP Lo</b>	The lower limited value
<b>--- COMP</b>	The limited value is invalid
<b>••• OFF</b>	Beep function is disabled



## 2.4 Buttons

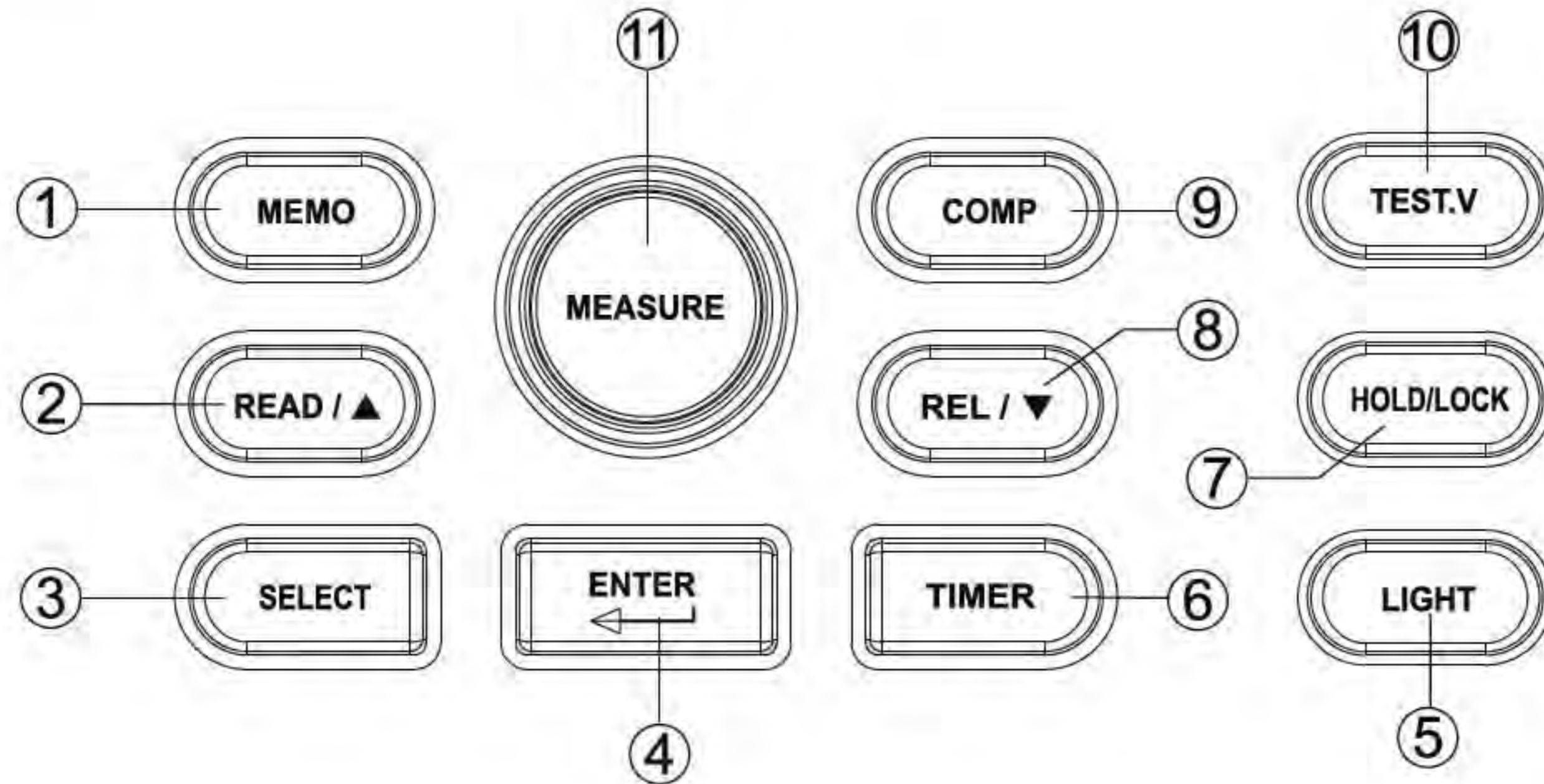



Buttons	Description
1	Active store function: store the measuring data to memory
2	Active read function,to view the data store in memory; change cursor position.
3	1 : in dcv ,acv,continuity mode to view the max value,min value ,avg value, upper limited value, lower limited value,relative value 2 : in insulation mode to view max value,min value ,avg value, upper limited value, lower limited value,preset timer,DAR,PI
4	Confirm Button
5	Back Light on/Off,when the light turn on ,after 10s the meter auto turn off light
6	Active the timer function
7	Active hold function(in DCV,ACV,Continuity) or lock function(Insulation)
8	Active rel function(in dcv,acv,continuity mode);change cursour position ;
9	Active compare function
10	Select one test output voltage for insulation test.
11	Active insulation test

## 2.5 Rotary switch

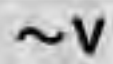
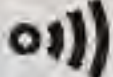
Position	Function
OFF	Turn off the meter power
 V	DC Voltage :0.1V~1000V
 V	AC Voltage 0.1V~750V
	Ohm and continuity :0.01Ω~200.0Ω
Insulation	Insulation Test 0.01MΩ~10.0GΩ , Test output Voltage 50V( default ), 100V、 250V、 500V、 1000V, the test output volatage have selected will be saved .

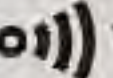

## 2.6 Input Terminal

Terminal	Description
HI  VΩ	Input /output positive terminal
COM	Common terminal except Inuslation measure
LO	Common terminal in Inuslation measure

## 3. Function Description

### 3.1 Power-Up Options

Holding a button down while turning the Meter on activates a power-up option. Power-up options allow you to use additional features and functions of the Meter. To select a power-up option, hold down the appropriate button indicated while turning the Meter from OFF to any switch position. Power-up options are cancelled when the Meter is turned Off

Buttons	Function
SELECT	Disables automatic power-off function Display shows PoFF until the button is released
ENTER	Disable Beep function

### 3.2 Automatic Power Off

The Meter have automatic power off function ( Sleep mode ) to conserve battery power .if there is no function change or button press for 10 minutes. The Meter comes out of Sleep mode when a key is pressed or when the rotary switched is changed.

To disable the Sleep mode, hold down SELECT button while turning the Meter on. Sleep mode is always disabled in the insulation test mode, or if the auto power off feature has been disabled by pressing SELECT button when the Meter is turned on.

### 3.3 Hold Funcion

Press Hold button to freeze the displayed value. Press again to release the display.

### 3.4 Relative Measurement

Show the difference between actual value and the relative base.

Press **REL** Button to enter relative measurement and the meter will record the initial value when pressing the key.



Displayed value = Actual value -Initial value

Press **REL** Button again to exit relative measurement.

Press **SELECT** button to view Initial value,when the Initial value is invalid,display ----.

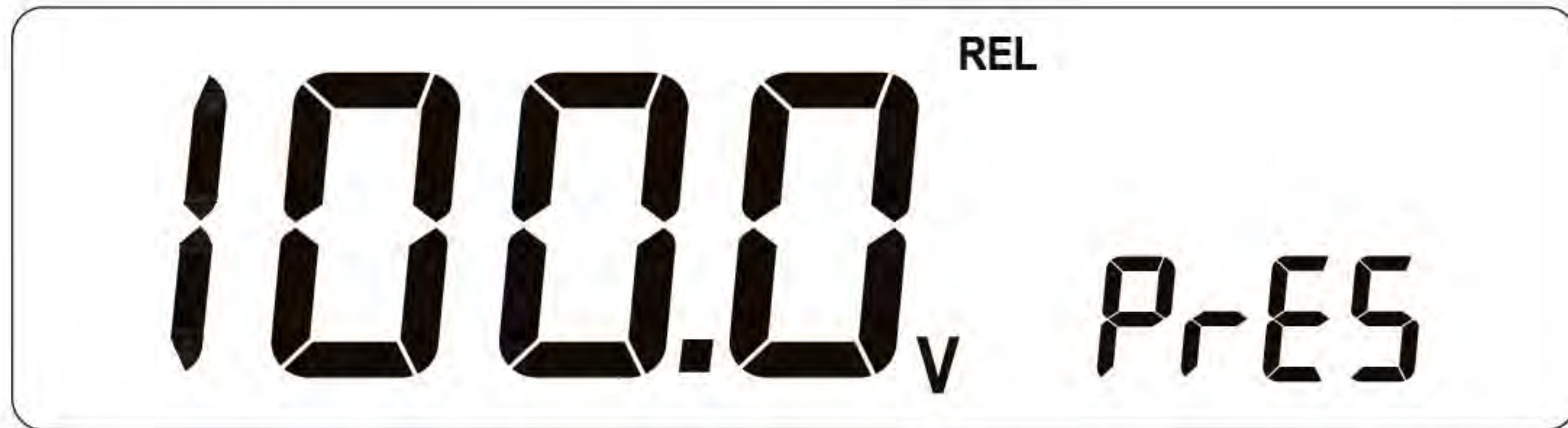

### 3.5 Insulation Test Lock

In insulation test mode, press Test button to perform insulation test until the button is released. when the button is released, the screen display hold sign.

Press Lock Button, then the screen display Lock sign, press Test Button, the meter will perform insulation test until you press Test button again; The test lock will be unlocked while to cancel insulation test.

Lock function is invalid when timer function is selected.



### 3.6 Storing Test Data

Press MEMO button, the meter enter Hold status automatically. LCD screen display 'MEMO' and the memory code on secondary display (see below). Press  $\Delta/\nabla$  button to change the code, press enter to save the data in the preferred memory code and the screen display 'SAVE'. The data is stored successfully when the buzz beeps. The meter can save 20 data and memory code from 00 to 19.

The image shows a digital LCD display. On the left, the main display shows '0000.0' followed by a small 'V' symbol. On the right, the secondary display shows 'MEMO' above 'n 00', where 'n' is a small character and '00' are two digits.

The image shows a digital LCD display with the characters '5A4E' displayed in a large, bold, segmented font.



### 3.7 Reading Test Data

Press READ button to display the data in memory. Press  $\Delta/\nabla$  button to change the code and read the data accordingly.



### 3.8 Delete Data

In READ mode, press ENTER, meter display dEL n, press enter button again to delete selected data; press READ button to delete all data. The meter will beep once the data is deleted. Press other button to quit the current status.





0000<sub>v</sub> n READ 00

dEL READ 8LL

### 3.9 Compare Function

When compare function is selected, the meter beeps and won't display 'PASS', when the measuring data higher than upper limited value or lower than lower limited value.

Press COMP button will active compare function.,meter display 'COMP',when the preset upper limited value is lower than the lower



limited value ,COMP function is invalid.,meter display '----' .

Press COMP button to view the upper and the lower limited value.The meter display 'COMP' and display 'HI' or 'LO' on secondary screen, as below: When the meter is displaying the upper limited value or the lower limited value, press ENTER to adjust the value. The meter will be flashing with the upper limited value or the lower limited value.Switch to the proper range or signal polar by pressing SELECT, Press  $\Delta/\nabla$  to change the value, and press ENTER to save the value.

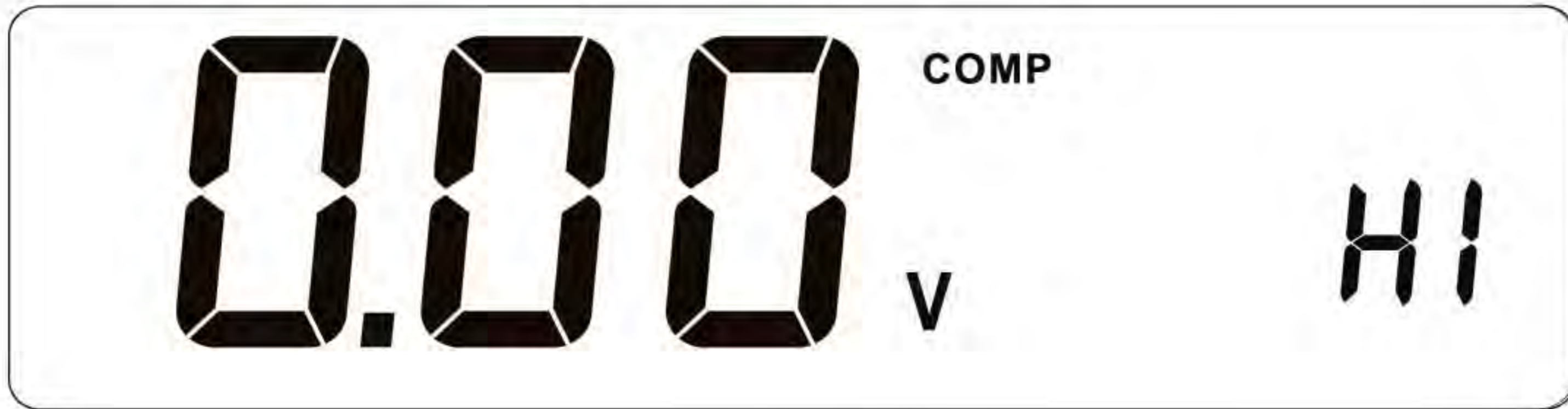





### 3.10 Timer Function

The timer function can only be activated in the insulation test. Enable the TIMER function by pressing TIMER (the meter display TIMER), the lock function will be invalid, and the meter starts the insulation test when pressing the measure button. When the time is due, the test is stopped.

In timer mode, the display will be as following. The current voltage and time is shown on the secondary display. The meter just display the test voltage when it is under the insulation test, to check the time, please press  $\Delta$  button.



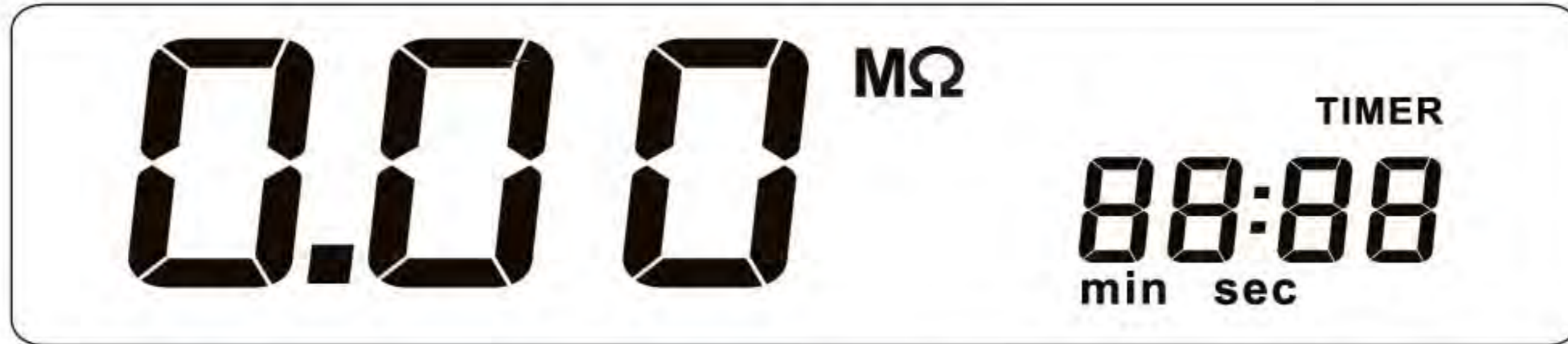

Press SELECT to check the preset time. The LCD screen display TIMER, PRES is shown on primary display, the secondary display shows the preset time. Press ENTER, the meter display Set. The time can be adjusted by  $\Delta/\nabla$  button. Presses ENTER again to confirm the adjustment.





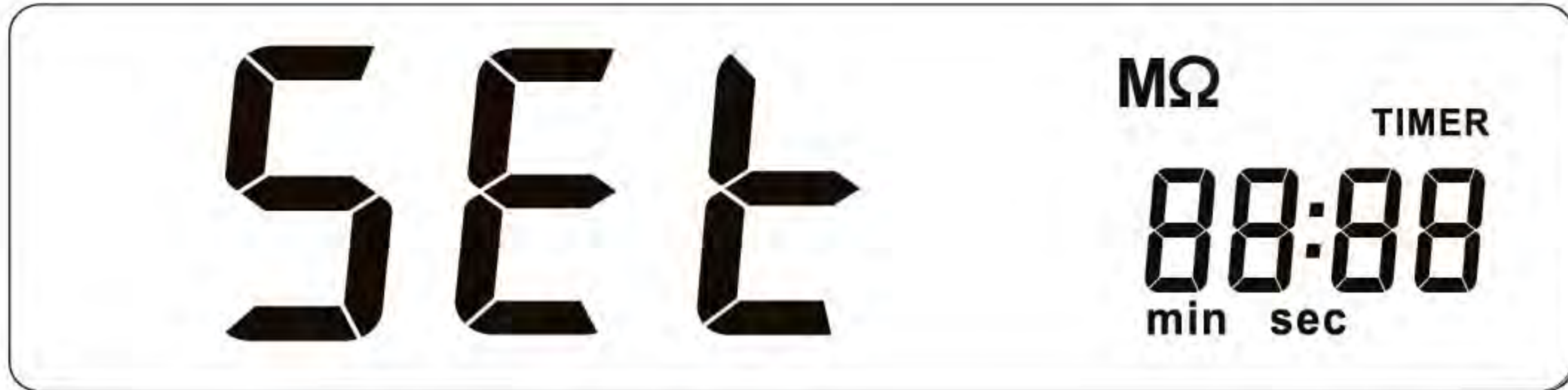

### 3.11 MAX/ MIN/AVG

In test mode , Press Select button to view max,min,average value ,In hold mode press select button to review max,min average value .

### 3.12 DAR & PI

Sometimes an insulation part with obvious drawbacks (e.g., the insulation part is broken through under high voltage) is nevertheless with a good absorption ratio (or polarization index). Therefore, absorption ratio (polarization index) cannot be used to discover local insulation drawbacks other than dampness and contamination.

$$\text{DAR (absorbing ratio)} = \frac{R_{60\text{Sec}}}{R_{15\text{Sec}}}$$

$$\text{PI(polarization index)} = \frac{R_{10\text{Min}}}{R_{1\text{Min}}}$$

R10Min= Resistance value measured 10 minutes after applying the test voltage; R1Min=R60Sec= Resistance value measured 10 minutes after applying the test voltage; R15Sec= Resistance value measured 10 minutes after applying the test voltage



After performed insulation test,press SELECT button to view DAR or PI .If DAR or PI Value invalid, the meter display - - - - .

#### 4. Making Basic Measurements

##### 4.1 Measuring DC Voltage

Switch rotary switch to  $\overline{\text{V}}$  position,Input terminals and test leads connecting as follows figure ,then connect test leads to circuit.

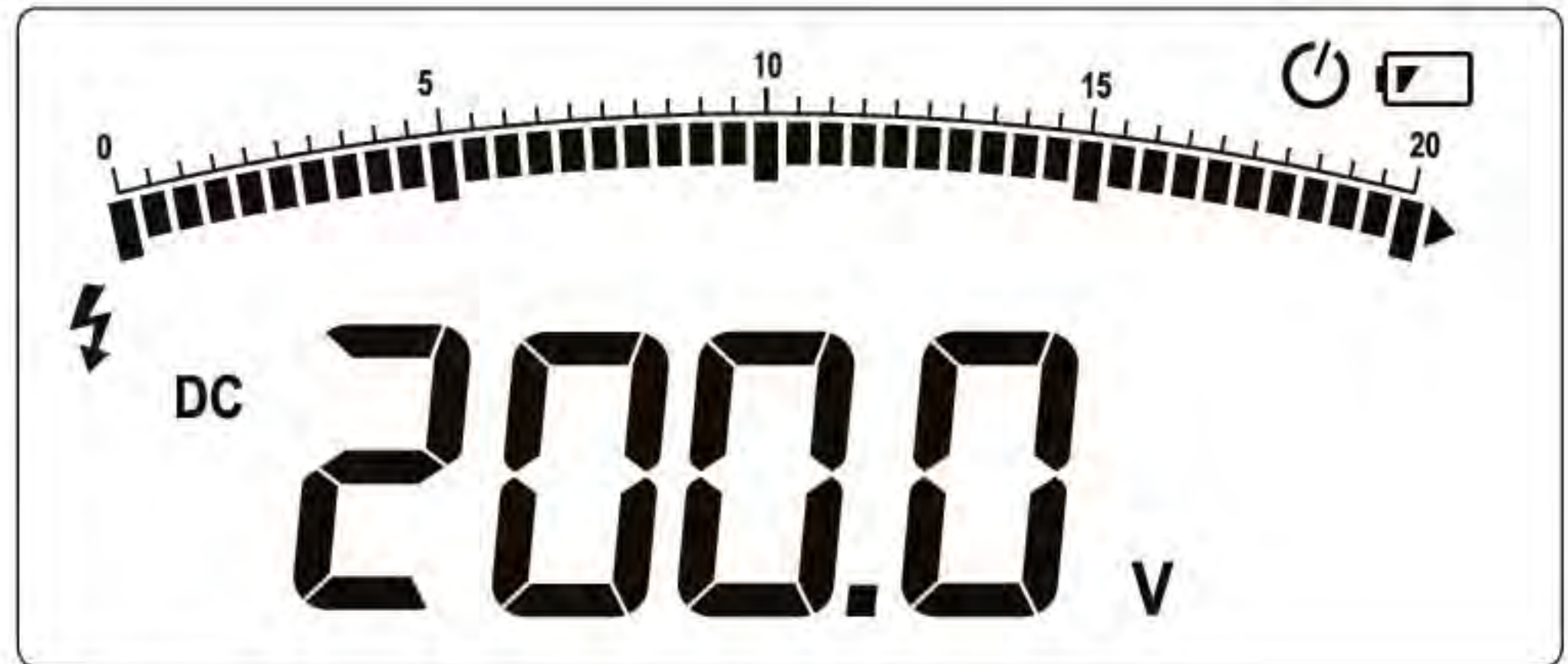
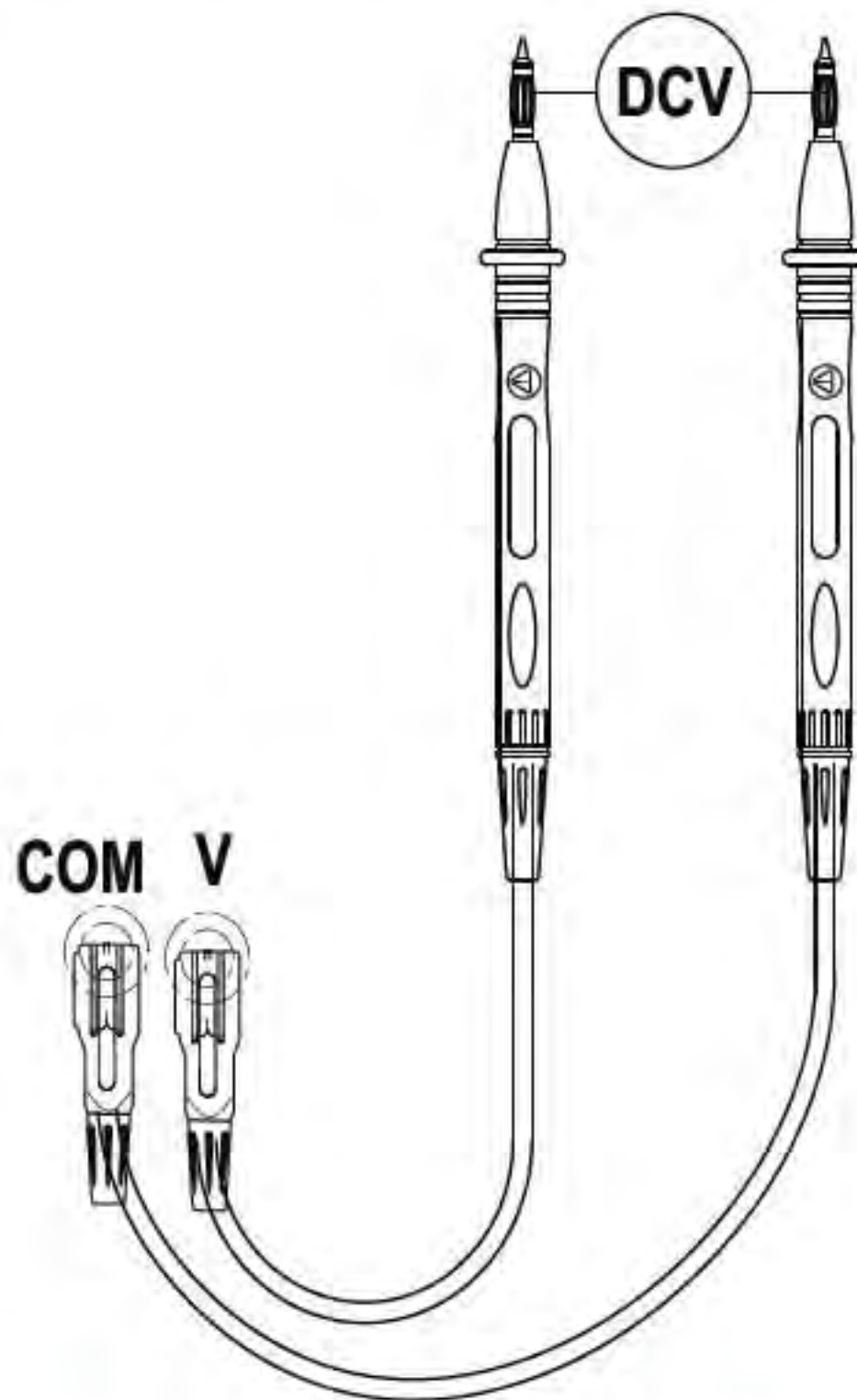



### 4.2 Measuring AC Voltage

Switch rotary switch to  $\sim$ V position, Input terminals and test leads connecting as follows figure ,then connect test leads to circuit.

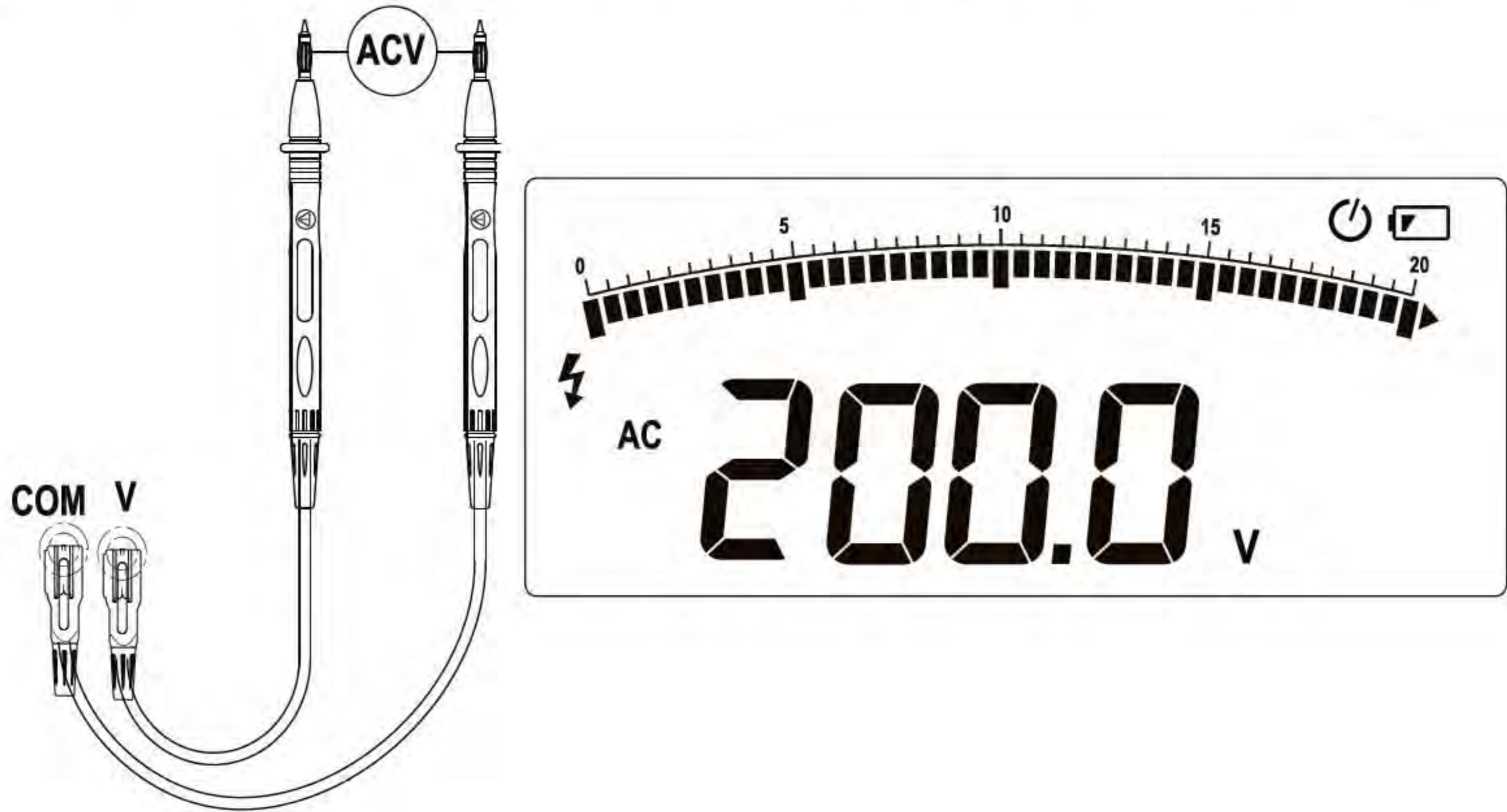



### 4.3 Measuring Resistance

To avoid possible damage to the Meter or to the equipment under test, disconnect circuit power and discharge all high voltage capacitors before testing for continuity.

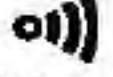
Switch rotary switch to  position, Input terminals and test leads connecting as follows figure , The continuity test features a beeper that sounds as long as a circuit is complete. The beeper sounds when a short ( $<3 \Omega$ ).

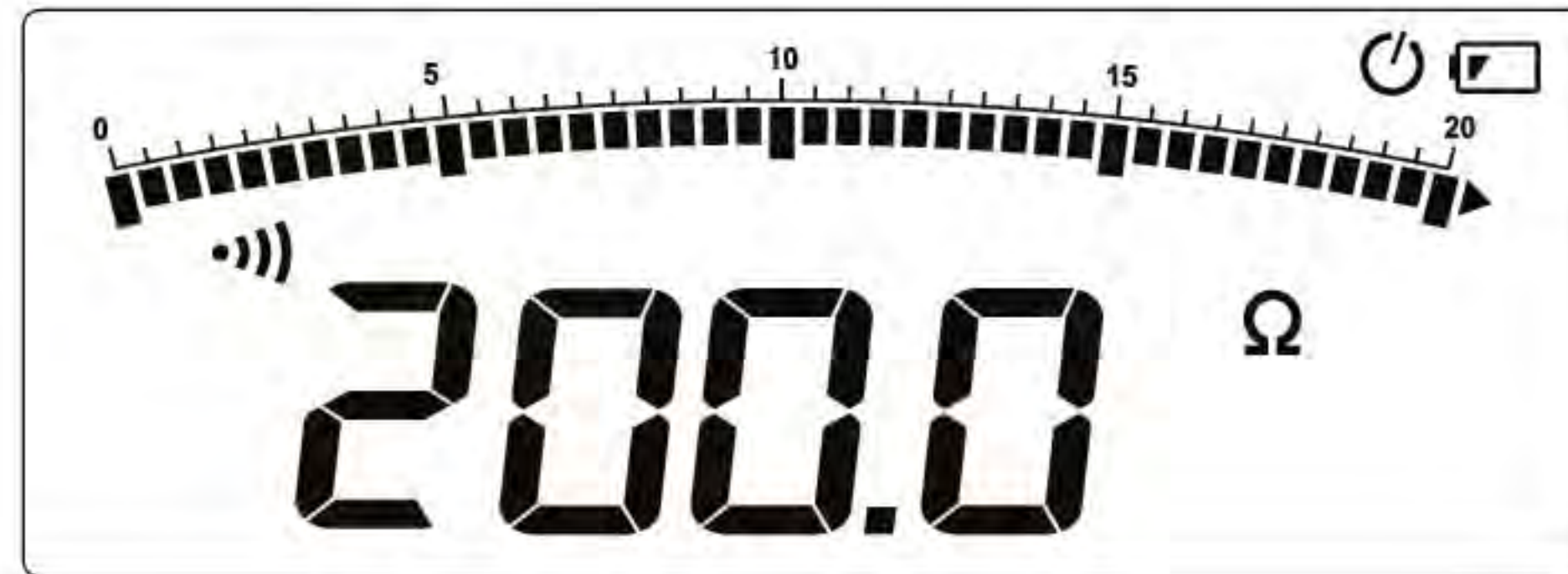
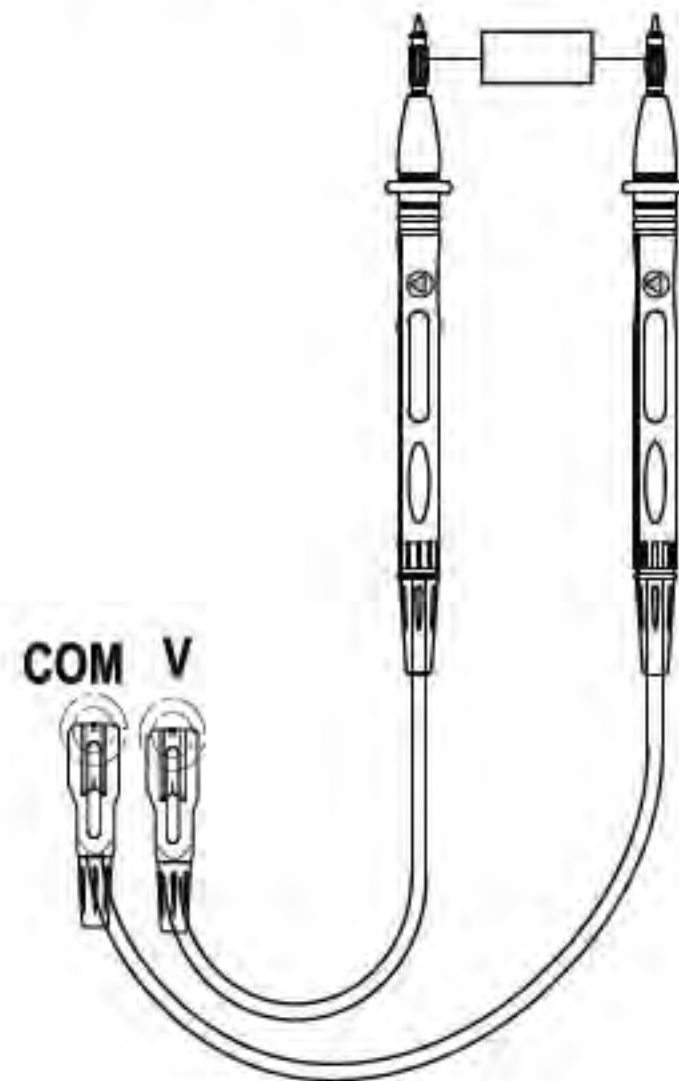

### 4.4 Insulation Test

**Warning** : When the test voltage output, do not rotate the rotary switch to prevent damage to the meter.

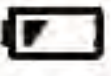
- Insulation tests should only be performed on dead circuits. Check the test leads before testing.
- Switch rotary to Insulation position.if meter display  ,please replease battery.
- Insert test leads to High、 Low terminals.if the meter display Live ,indicator the meter cannot measure on live circuit.please power off Live



circuit..

- Press TEST.V button to select output voltage;
- In insulation measuring ,the screen alternate turn (TEST) on or off ,the primary screen display the resistance value,and the secondary screen display the Output voltage. Release the test button then discharges through the Meter,the meter display DISC.
- The secondary Display 0 VDC indicator when the voltage discharge finished.
- Disconnect the test leads from circuit.

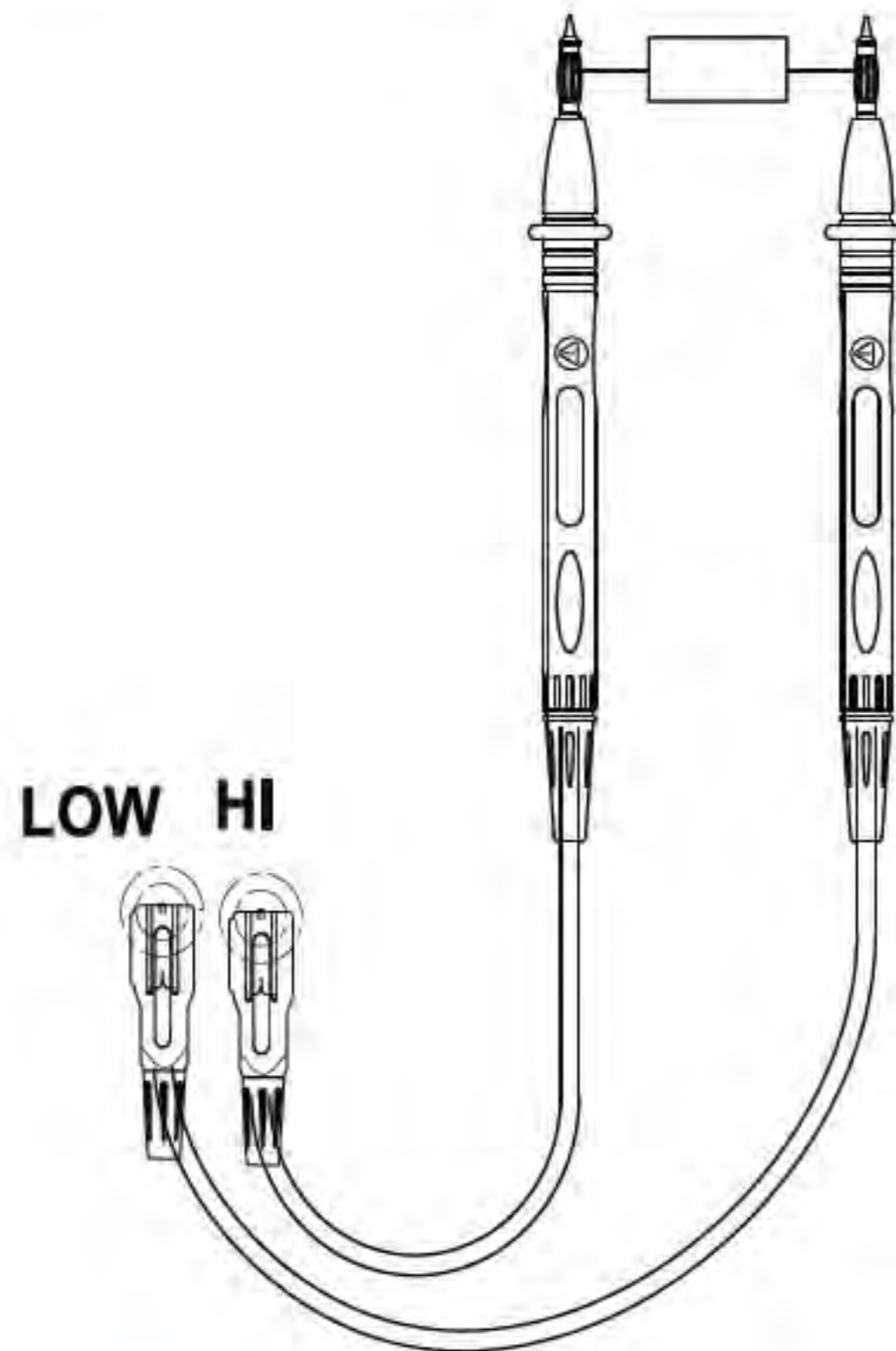



## 5. Replacing battery

To avoid false readings, which could lead to possible electric shock or personal injury, replace the batteries as soon as the battery indicator  appears.

Turn the rotary switch to OFF and remove the test leads from the terminals.

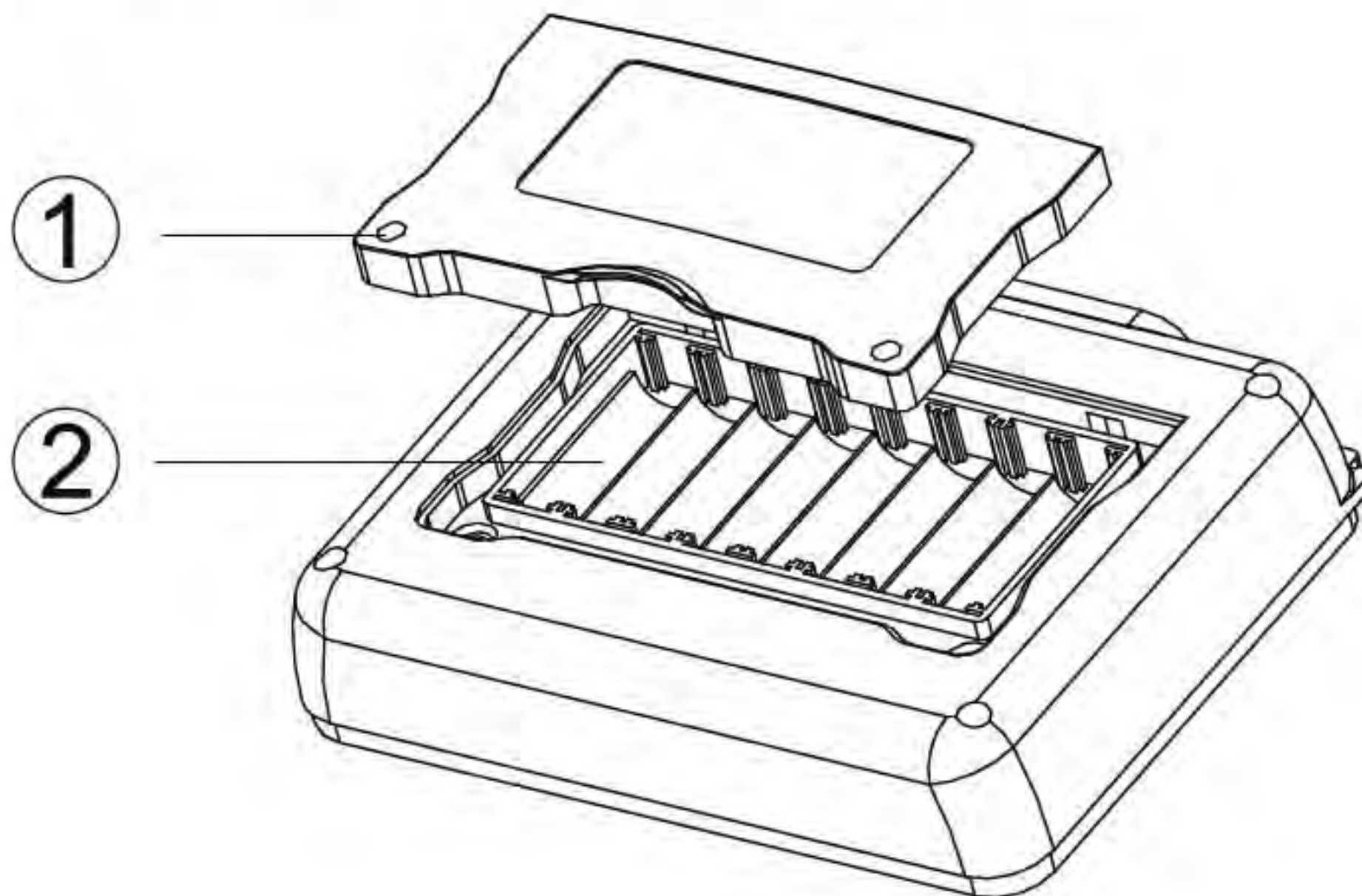

**1**: Screw

**2**: Battery