

# **RIGOL**

## **User's Guide**

# **DG1000 Series Dual-Channel Function/Arbitrary Waveform Generator**

**Dec. 2014**

**RIGOL Technologies, Inc.**



---

## Guaranty and Declaration

### Copyright

© 2008 RIGOL Technologies, Inc. All Rights Reserved.

### Trademark Information

**RIGOL** is registered trademark of **RIGOL** Technologies, Inc.

### Publication Number

UGB06139-1210

### Software Version

00.03.00

Software upgrade might change or add product features. Please acquire the latest version of the manual from **RIGOL** website or contact **RIGOL** to upgrade the software.

### Notices

- **RIGOL** products are covered by P.R.C. and foreign patents, issued and pending.
- **RIGOL** reserves the right to modify or change parts of or all the specifications and pricing policies at company's sole decision.
- Information in this publication replaces all previously corresponding material.
- Information in this publication is subject to change without notice.
- **RIGOL** shall not be liable for either incidental or consequential losses in connection with the furnishing, use or performance of this manual as well as any information contained.
- Any part of this document is forbidden to be copied, photocopied or rearranged without prior written approval of **RIGOL**.

### Product Certification

**RIGOL** guarantees this product conforms to the national and industrial standards in China as well as the ISO9001:2008 standard and the ISO14001:2004 standard. Other international standard conformance certification is in progress.

### Contact Us

If you have any problem or requirement when using our products or this manual, please contact **RIGOL**.

E-mail: [service@rigol.com](mailto:service@rigol.com)

Website: [www.rigol.com](http://www.rigol.com)

## Safety Notices

Review the following safety precautions carefully before operating the instrument to avoid any personal injury or damage to the instrument or products connected to it. To avoid potential hazards, use the instrument in the manner specified in this user's guide.

**The instrument should be serviced only by qualified personnel.**

**Avoid Fire or Personal Injury.**

**Use Proper Power Line.** Only the special power line of the products approved by the State should be used.

**Ground the Instrument.** This generator is grounded through the protective terra conductor of the power cord. To avoid electric shock, the grounding conductor must be connected to the earth ground. Make sure that the instrument is properly grounded before connecting the input or output terminals.

**Observe All the Ratings of the Terminal.** To avoid fire or shock, observe all the ratings and symbols that marked on the instrument. Read the user's guide carefully before making connections to the instrument.

**Do not Operate without Covers.** Do not operate your generator without covers or panels.

**Use Proper Fuse.** Only use the fuse type and rating specified for this product.

**Avoid Circuit or Wire exposed.** Do not touch the exposed connections or components when the power is turn-on.

**Do not operate with suspected failures.** If you suspect there is damage with this product, have it inspected by qualified service personnel authorized by RIGOL before further operations.

**Provide Proper Ventilation.**

**Do not Operate in Wet/Damp Conditions.**

**Do not Operate in an Explosive Atmosphere.**

**Keep the Product's Surfaces Clean and Dry.**

## Safety Terms and Symbols

**Terms in This Guide.** These terms may appear in this manual:



**WARNING:** Warning statements indicate the conditions or practices that could result in injury or loss of life.



**CAUTION:** Caution statements indicate the conditions or practices that could result in damage to this product or other property.

**Terms on the Product.** These terms may appear on the product:

**DANGER** It calls attention to an operation, if not correctly performed, could result in injury or hazard immediately.

**WARNING** It calls attention to an operation, if not correctly performed, could result in potential injury or hazard.

**CAUTION** It calls attention to an operation, if not correctly performed, could result in damage to the product or other devices connected to the product.

**Symbols on the Product.** These symbols may appear on the product:



**Hazardous  
Voltage**



**Refer to the  
Instructions**



**Protective  
earth terminal**



**Grounding  
Terminal  
of Chassis**



**Test  
Grounding  
Terminal**

## Instrument at a Glance

**RIGOL** DG1000 series Dual-Channel Function/Arbitrary Waveform Generator adopts the DDS (Direct Digital Synthesis) technology, which can provide stable, high-precision, pure and low distortion sine signal. It can also provide 5MHz square waveform with fast rising and falling edges. In additional, frequency measurement function with high accuracy and wide frequency band is also provided. The combination of excellent system features, easiness in usage and versatile functions makes this generator a perfect solution for your job now and in the future.

DG1000 series Dual-Channel Function/ Arbitrary Waveform Generator have clear and simple Front-Panel. The user-friendly panel layout and instructions, versatile interfaces, direct graph interface, built-in instructions and help system have greatly simplified the operation process, thus, users do not have to spend a great deal of time learning and familiarizing the operation of the generator before they can use it proficiently. The built-in AM, FM, PM and FSK modulating functions generate modulated waveform at ease, without the help of a separate modulating source. The USB I/O is the standard accessory.

### Main Features:

- DDS technology provides precise, stable and low distortion signal.
- 2-Channel Output.
- Support channel coupling, channel copy.
- 5 basic waveforms and 48 built-in arbitrary waveforms output.
- 100MSa/s sampling rate, enable to edit arbitrary waveform with 14-bit, 4k points.
- Abundant modulation function, various modulated waveform: AM, FM, PM and FSK.
- Linear, logarithm Sweep and Burst mode.
- Abundant I/O interfaces: External Modulation Source, External 10 MHz Reference Input, External trigger source, waveform output, synchronous signal output.
- Counter with high accuracy and wide frequency band can measure frequency, period, duty cycle, positive pulse width and negative pulse width of the signal with the frequency from 100mHz to 200MHz (single channel).
- Support USB flash storage device. You can store waveform parameters or the edited arbitrary waveform in USB flash storage device or read the waveform stored in the device as well as updating the system using the device.

- Standard interfaces: USB Host & USB Device.
- Interconnect with DS1000 series oscilloscope seamlessly, acquire the waveform stored in the oscilloscope and output it lossless.
- Connect with the power amplifier (PA1011), amplifier and then output the signal.
- Graph interface which shows the signal settings directly.
- Embedded Chinese and English Help System.
- Support Chinese and English Input.

### **Content Conventions in this Manual:**

DG1000 series Dual-channel Function/Arbitrary Waveform Generator includes DG1022 and DG1022A. Illustrations in this manual are based on DG1022, but all the functions and performance of DG1022A have been contained.

# Contents

Guaranty and Declaration .....	I
Safety Notices.....	II
Safety Terms and Symbols.....	III
Instrument at a Glance .....	IV
<b>Chapter 1 Quick Start .....</b>	<b>1-1</b>
General Inspection .....	1-2
Handle Adjustment.....	1-3
The Front/Rear Panel .....	1-4
User Interface.....	1-6
To Set a Waveform .....	1-7
To Set the Output .....	1-10
To Set Modulate/Sweep/Burst .....	1-11
To Use Digital Input .....	1-13
To Use Store/Utility/Help Function .....	1-14
<b>Chapter 2 Operating Your Generator .....</b>	<b>2-1</b>
To Set Basic Waveforms .....	2-2
To Set Sine Waveform .....	2-2
To Set Square Waveform .....	2-7
To Set Ramp Waveform.....	2-10
To Set Pulse Waveform.....	2-12
To Set Noise Waveform .....	2-15
To Set Arbitrary Waveforms .....	2-16
To Select Arbitrary Waveform.....	2-17
To Edit Arbitrary Waveform.....	2-20
To Set Modulated Waveforms.....	2-26
To Set AM Waveform.....	2-27
To Set FM Waveform.....	2-29
To Set FSK Waveform.....	2-31
To Set PM Waveform.....	2-33
To Generate Sweep Signal .....	2-35
To Generate Burst Signal .....	2-37
To Store and Recall .....	2-41
To Set the Utility Function.....	2-48
To Set the Sync Output .....	2-50



Basic Setting of the Two Channels.....	2-52
Channel Coupling Settings.....	2-55
To Set the Counter .....	2-57
System Settings.....	2-62
I/O Settings .....	2-69
Test/Cal Settings .....	2-70
Power Amplifier Settings .....	2-72
To Lock the Keyboard.....	2-73
To Use the Help System .....	2-75
<b>Chapter 3 Examples .....</b>	<b>3-1</b>
Output from Single Channel .....	3-2
Example 1: Output a Sine Waveform .....	3-2
Example 2: Output a Square Waveform .....	3-3
Example 3: Output a Ramp Waveform .....	3-4
Example 4: Output a Pulse Waveform.....	3-5
Example 5: Output a Noise Waveform .....	3-6
Example 6: Output a Stored Arbitrary Waveform.....	3-7
Example 7: Create an Arbitrary Waveform.....	3-8
Example 8: To Generate a AM Waveform .....	3-10
Example 9: To Generate a FSK Waveform .....	3-12
Example 10: To Generate a Linear Sweep Waveform.....	3-13
Example 11: To Generate a Burst Waveform.....	3-15
Output from Double Channels .....	3-16
Example for Channel Coupling.....	3-19
Example for Channel Copy .....	3-21
To Measure with the Counter .....	3-22
<b>Chapter 4 Prompt Messages &amp; Troubleshooting.....</b>	<b>4-1</b>
Prompting Messages .....	4-2
Common Messages.....	4-2
Error Messages .....	4-4
Data Overflow .....	4-5
Troubleshooting.....	4-15
<b>Chapter 5 Specifications.....</b>	<b>5-1</b>
Characteristics .....	5-2
General Specifications .....	5-8
<b>Chapter 6 Appendix.....</b>	<b>6-1</b>
Appendix A: Accessories .....	6-1

Appendix B: Warranty ..... 6-2  
Appendix C: General Care and Cleaning..... 6-3

## Chapter 1 Quick Start

This chapter covers the following topics:

- General Inspection
- Handle Adjustment
- The Front/Rear Panel
- User Interface
- To Set a Waveform
- To Set the Output
- To Set Modulation/Sweep/Burst
- To Use Digital Input
- To Use Store/Utility/Help Function

## General Inspection

When you get a new DG1000 series Dual-Channel Function/Arbitrary Waveform Generator, you are suggested to take the following steps to inspect the instrument.

**1. Inspect the shipping container for damage.**

If there are damages in the packing or foam, keep them until the whole machine and the accessories passing the electric and mechanical testing.

**2. Check the accessories.**

Accessories supplied with the instrument are listed in "*Appendix A: Accessories*". If the contents are incomplete or damaged, please contract the local selling representative of **RIGOL**.

**3. Inspect the instrument.**

In case any mechanical damage or defect, or if the instrument does not operate properly or pass performance tests, notify your **RIGOL** Sales Representative.

The consigner or carrier shall be liable for the damage to instrument resulting from shipment. **RIGOL** would not be responsible for free maintenance/rework or replacement of the unit.

## Handle Adjustment

To adjust the handle position of the Generator, please grip the handle by the sides and pull it outward. Then, make the handle rotate to the desired position. The operating methods are shown below in Figure 1-1 and Figure 1-2.

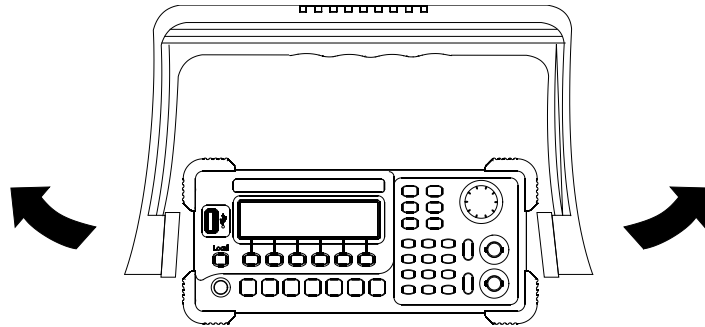

Figure 1-1 Handle Adjusting

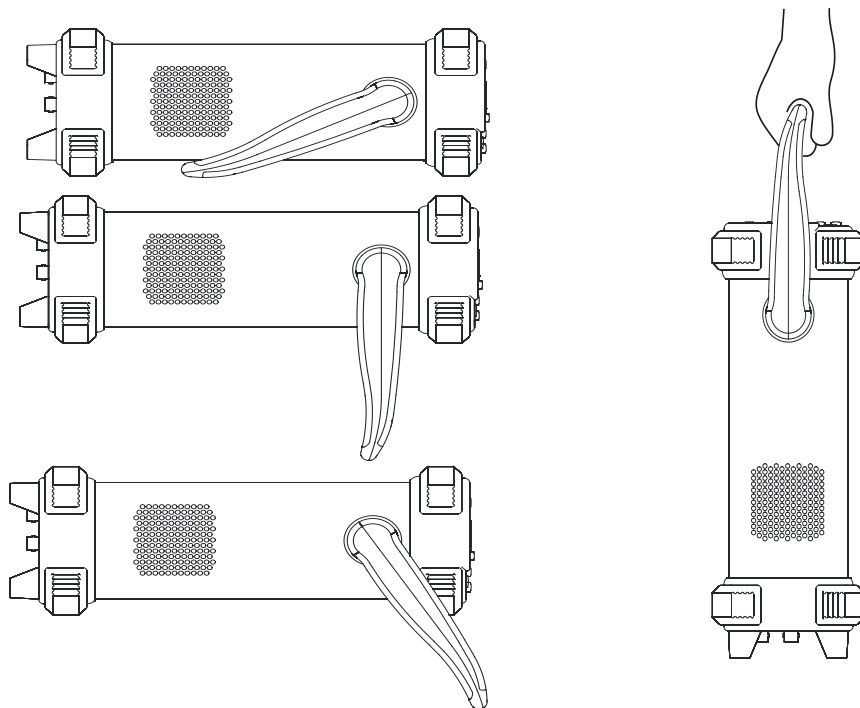

Figure 1-2 Adjustable Positions

# The Front/Rear Panel

When you get a new DG1000 series Dual-Channel Function/Arbitrary Waveform Generator, first you need to know how to operate the front/ Rear panel correctly. This chapter will make a brief introduction and description for the operation and functions of the Front/ Rear Panel.

## Front Panel at a Glance

DG1000 series Generator has clear and simple front panel. The Front Panel has a knob, functional keys and menu buttons. The 6 grey buttons below the screen are menu buttons, by using which you can choose different options on the current menu. The rests are the functional keys, with which you can enter different function menus or obtain specific functional applications directly.

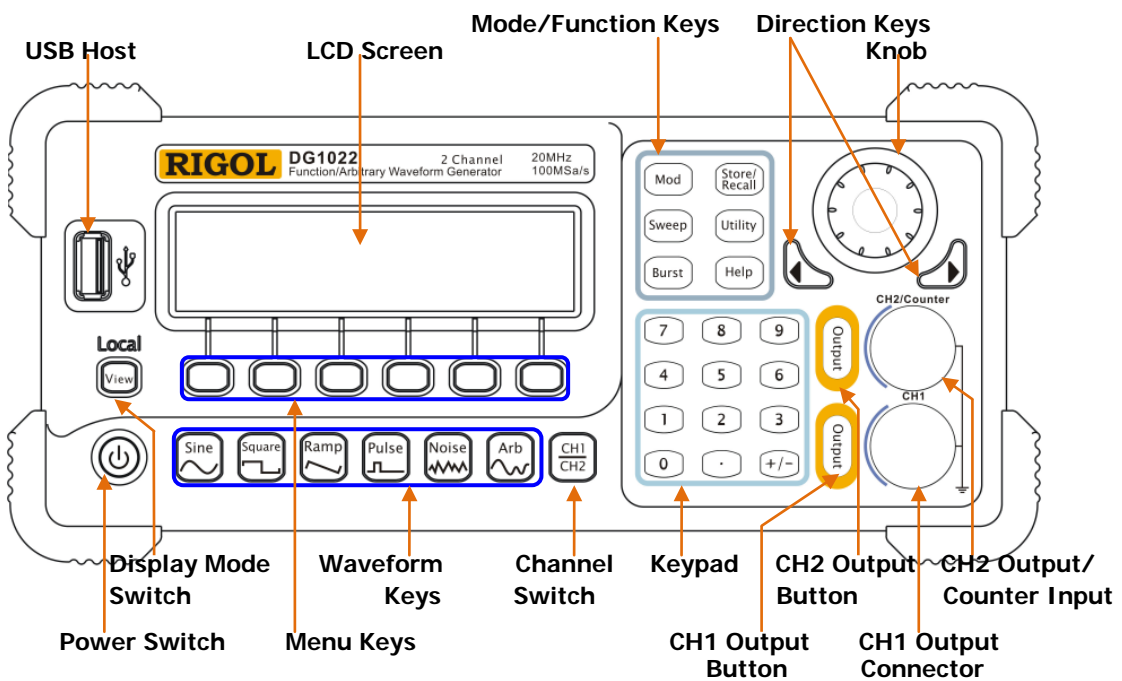

Figure 1-3  
Front Panel for DG1000

## Rear Panel at a Glance

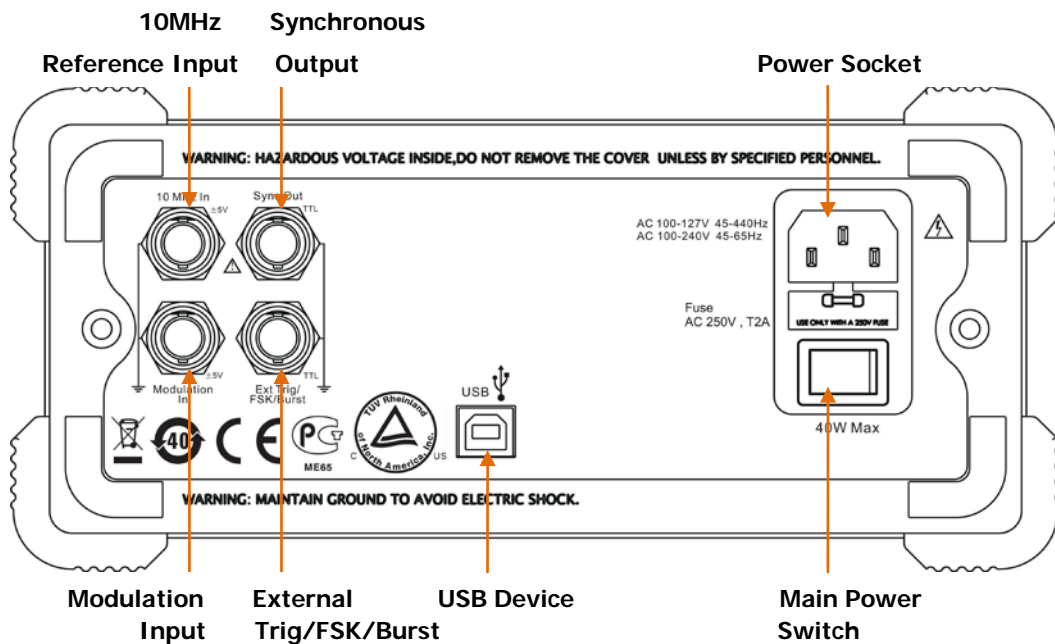



Figure 1-4  
Rear Panel for DG1000

# User Interface

The Generator provides three display modes: Menu Mode (Single or Double Channel) and Graph Mode (Single Channel). To switch the display mode, press the **View** button.

To select Channels, press the  button.

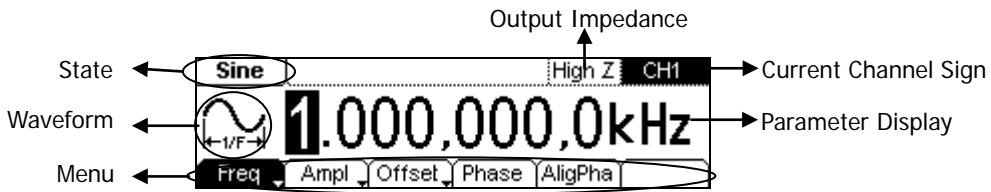

Figure 1-5  
User Interface in Menu Mode (Single Channel)

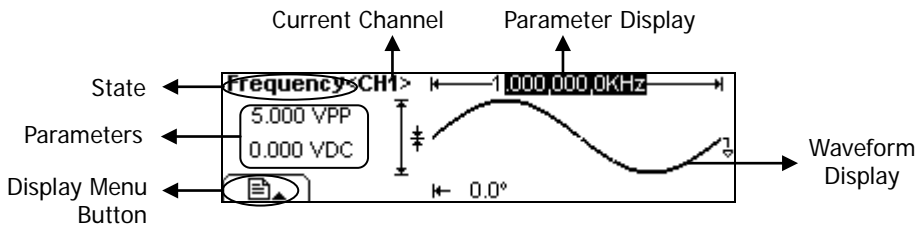

Figure 1-6  
User Interface in Graph Mode (Single Channel)

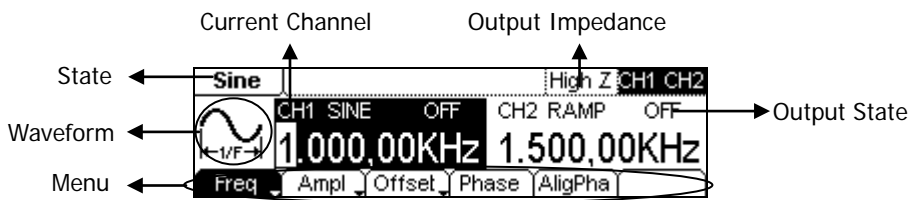

Figure 1-7  
User Interface in Menu Mode (Double Channel)

**NOTE:**

The buttons on the front panel of the instrument are represented by words in a pane, such as **Sine** which represents the functional key with “Sine” on it on the front panel, while the menu buttons are represented by shadow words such as **Freq**, which means the “Frequency” option in the **Sine** menu.



## To Set a Waveform

At the left of the operation panel, there are several buttons with waveform icon and two buttons which are used commonly. The following exercises will help you to be familiar with the waveform selection settings. The instructions of the waveform settings are all carried out in the Menu Display Mode.

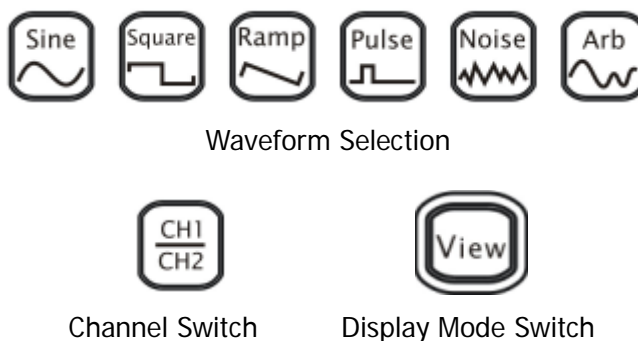

Figure 1-8 Function Buttons Selection

1. Press the **Sine** button, a "Sine" typeface will display in the state area. By setting *Frequency/Period, Amplitude/High Level, Offset/Low level and Phase*, Sine signal with different parameters can be generated.

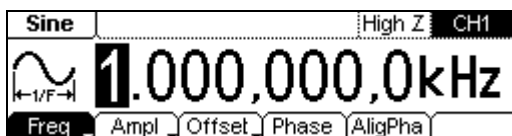

Figure 1-9

Sine Signal in the Menu Display Mode

As shown in Figure 1-9, the default signal parameters are: 1kHz Frequency, 5.0V<sub>PP</sub> Amplitude, 0 V<sub>DC</sub> Offset and 0° initial phase.

2. Press the **Square** button, a "Square" typeface will display in the state area. By setting *Frequency/Period, Amplitude/ High Level, Offset/ Low level, Duty Cycle and Phase*, Square signal with different parameters can be generated.

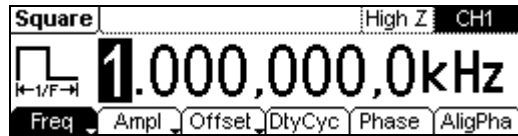

Figure 1-10  
Square Signal in the Menu Display Mode

As shown in Figure 1-10, the default signal parameters are: 1kHz Frequency, 5.0V<sub>PP</sub> Amplitude, 0 V<sub>DC</sub> Offset, 50% Duty Cycle and 0° initial phase.

3. Press the **Ramp** button, a “Ramp” typeface will display in the state area. By setting *Frequency/Period, Amplitude/ High Level, Offset/ Low level, Symmetry and Phase*, Ramp signal with different parameters can be generated.

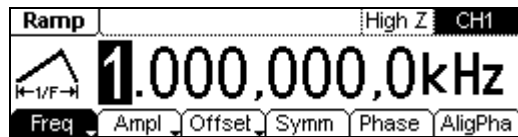

Figure 1-11  
Ramp Signal in the Menu Display Mode

As shown in Figure 1-11, the default signal parameters are: 1kHz Frequency, 5.0 V<sub>PP</sub> Amplitude, 0 V<sub>DC</sub> Offset, 50% Symmetry and 0° initial phase.

4. Press the **Pulse** button, a “Pulse” typeface will display in the state area. By setting *Frequency/Period, Amplitude/ High Level, Offset/ Low level, Pulse Width/Duty Cycle and Delay*, Pulse signal with different parameters can be generated.

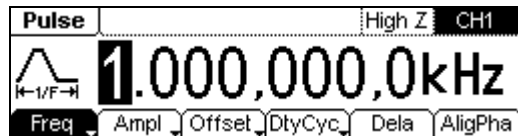

Figure 1-12  
Pulse Signal in the Menu Display Mode

As shown in Figure 1-12, the default signal parameters are: 1kHz Frequency, 5.0V<sub>PP</sub> Amplitude, 0 V<sub>DC</sub> Offset, 50% Duty Cycle, 500μs Pulse Width and 0s Delay.

5. Press the **Noise** button, a "Noise" typeface will display in the state area. By setting *Amplitude/High Level, Offset/Low level*, Noise signal with different parameters can be generated.



Figure 1-13

Noise Signal in the Menu Display Mode

As shown in Figure 1-13, the default signal parameters are: 5.0 V<sub>PP</sub> Amplitude and 0 V<sub>DC</sub> Offset.

6. Press the **Arb** button, an "Arb" typeface will display in the state area. By setting *Frequency/Period, Amplitude/ High Level, Offset/ Low level and Phase*, arbitrary waveform signals with different parameters can be generated.

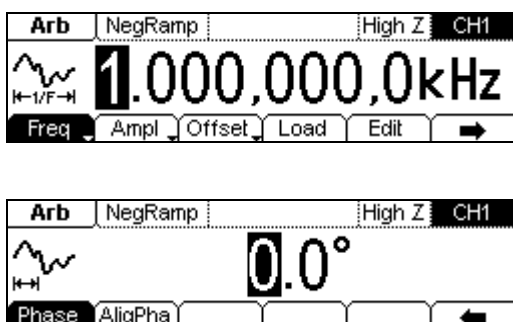

Figure 1-14

Arbitrary waveform Signal in the Menu Display Mode

As shown in Figure 1-14, the default signal parameters are: 1kHz Frequency, 5.0 V<sub>PP</sub> Amplitude, 0 V<sub>DC</sub> Offset and 0° initial phase.

7. Press the **CH1** / **CH2** button, the channel will switch between CH1 and CH2. Users can edit parameters of the current selected channel.
8. Press the **View** button, the display modes will switch between Menu Mode in single channel, Graph Mode in single channel and Menu Mode in double channel. If the instrument is in remote mode, press this button it will return to local mode.

## To Set the Output

As shown in Figure 1-15, there are two **Output** buttons on the right side of the front panel, which are used to set the Output Control. The instruction below will help you to be familiar with these functions.

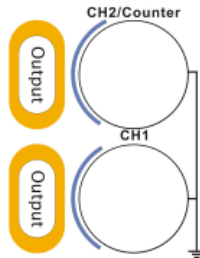

Figure 1-15 Channel Output/Counter Input

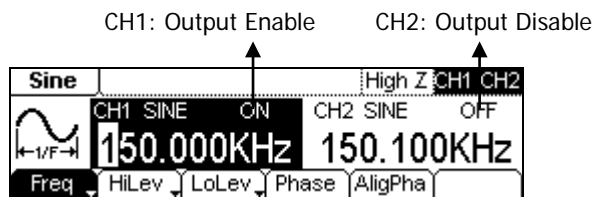

Figure 1-16 Channel Output Control

### 1. Channel Output Control

Press the **Output** button to enable/disable the signal output of CH1 or CH2.

### 2. Counter Input

In the Counter mode, the output connector of CH2 is used as the signal input terminal. At the same time, the output of CH2 will be disabled automatically.

## To Set Modulate/Sweep/Burst

As shown in the following figure, there are three buttons on the front panel, which are used for Modulation, Sweep and Burst settings. The instructions below will help you to be familiar with the settings of these functions.



Figure 1-17

Modulate/ Sweep/ Burst button

**NOTE:** **Mod**, **Sweep** and **Burst** functions are only used for CH1.

1. Press the **Mod** button, and a Modulated waveforms will be generated. Parameters are set by using the menu buttons. The modulated waveform can be changed by changing the parameters such as Type, Internal/external Modulation, Depth, Frequency, Waveform, etc.

DG1000 can modulate waveform using AM, FM, PM and FSK. Sine, Square, Ramp or Arbitrary waveforms can be modulated (Pulse, Noise and DC cannot be modulated).



Figure 1-18

Modulated Waveform Signal in the Menu Display Mode

2. Press the **Sweep** button, Sine, Square, Ramp or Arbitrary waveform can be swept (Pulse, Noise and DC can not be swept).

In the Sweep Mode, DG1000 generate signal with variable frequencies.

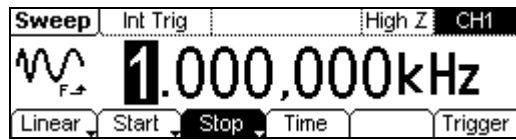

Figure 1-19

Sweep Waveform Signal in the Menu Display Mode

- Press the **Burst** button, Burst for Sine, Square, Ramp, Pulse or Arbitrary waveform can be generated (Noise can only be used in the gated Burst).

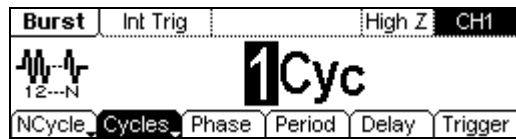

Figure 1-20

Burst Waveform Signal in the Menu Display Mode

### Term Explanation

**Burst:** Output Waveforms with the set cycle times

Burst can last for certain times of waveform cycle (N-Cycle Burst) or be controlled by external gated signals (Gated Burst). Burst applies to all kinds of waveforms (except DC), but noise can only be used in gated burst.

## To Use Digital Input

As shown in Figure 1-21, there are two groups of buttons on the operation panel, which are direction keys, the knob and the keypad. The instruction below will help you to be familiar with the Digital Input Function.

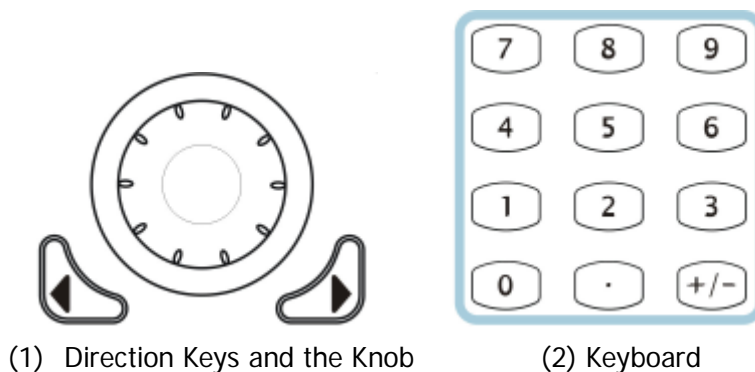

Figure 1-21  
Front Panel Digital Input

### Direction Keys

Switch the digital of a numerical value or the storage position of arbitrary waveform/setting files.

### Knob

- Change the numerical value. Rotate clockwise to increase and counterclockwise to decrease.
- Switch the types of built-in waveforms, storage location of arbitrary waveform/setting files, and the letter when input a file name.

### Keyboard

Directly input numerical value to change parameters.

## To Use Store/Utility/Help Function

As shown in Figure 1-22, there are three buttons on the operation panel, which are used to call the store/recall, utility and help function. The instruction below will help you to be familiar with these Functions.



Figure 1-22  
Store/Recall, Utility and Help Button

1. The **Store/Recall** Button is used to store waveform data and configure information.
2. The **Utility** Button is used to set the auxiliary system function, change the output configure parameters, interface setting, system setting information or perform the instrument self-test and the calibration, etc.
3. The **Help** Button is used to read the help information.

### Operation Instructions

#### To get help:

Press the key and last for 2~3 seconds, then the help message will appear.



## Chapter 2 Operating Your Generator

By now you have got a brief understanding of DG1000 with the front/rear panel, every function control area and keys.

This chapter covers the following topics:

- To Set Basic Waveforms
  - To Set Sine Waveform*
  - To Set Square Waveform*
  - To Set Ramp Waveform*
  - To Set Pulse Waveform*
  - To Set Noise Waveform*
- To Set Arbitrary Waveforms
  - To Select Arbitrary Waveform*
  - To Edit Arbitrary Waveform*
- To Set Modulated Waveforms
  - To Set AM Waveform*
  - To Set FM Waveform*
  - To Set FSK Waveform*
  - To Set PM Waveform*
- To Generate Sweep Signal
- To Generate Burst Signal
- To Store and Recall
- To Set the Utility Function
  - To Set the Sync Output*
  - Basic Setting of the Two Channels*
  - Channel Coupling Settings*
  - To Set the Counter*
  - System Settings*
  - I/O Settings*
  - Test/Cal Settings*
  - Power Amplifier Settings*
- To Lock the Keyboard
- To Use the Help System

## To Set Basic Waveforms

### To Set Sine Waveform

In the Menu Mode, press the **Sine** button to call the Sine operation. The top left corner of the screen will show the name of the current waveform. The output Sine waveform parameters are set using the Sine operation menu.

The parameters for Sine waveforms are: *Frequency/ Period, Amplitude/ High Level, Offset/ Low Level and Phase*. Different Sine Signals are generated by using these parameters. As shown in Figure 2-1, select **Freq** in the operation menu and the frequency parameter will be shown in the parameter area. Users then can change the frequency by using the direction keys and the knob or the keypad.

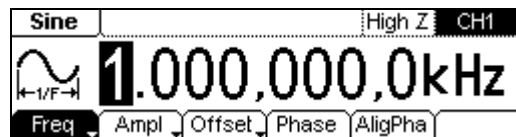

Figure 2-1  
Sine Signal Parameter Setting Interface

Table 2-1 Operation Menu for Sine Signal

Menu	Settings	Explanation
Frequency/ Period		Setting the signal's frequency or period; the current parameter will switch at a second press.
Amplitude/ High Level		Setting the signal's Amplitude or High Level; the current parameter will switch at a second press.
Offset/ Low Level		Setting the signal's Offset or Low Level; the current parameter will switch at a second press
Phase		Setting the initial phase of the signal

**NOTE:**

Waveforms in single channel needn't to set the **Aligpha** parameter. It is always used to align the phases of the two channels' output signals.

## To Set the Output Frequency/Period

1. Press **Sine** → **Freq/Period** → **Freq**, to set the frequency parameter.

The frequency shown on the screen is the default value when the instrument is powered or the set value beforehand. When setting the function, if the current value is valid for the new waveform, it will be used sequentially. If you want to set the period for the waveform, press **Freq/Period** button again, switch to the **Period** parameter (The current operation is displayed in inverse color).

2. Input the desired frequency.

Use the keypad to input the parameter value directly, and press the corresponding button to select the parameter unit. Or you can use the direction keys to select the digit you want to edit, and then use the knob to change its value.

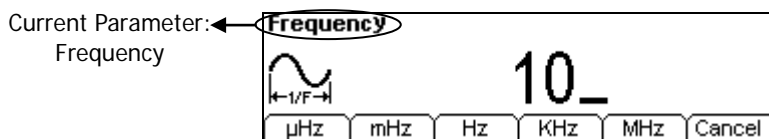

Figure 2-2  
Setting the Frequency

### Instructions

- When using the keypad to enter the digit, you can use the Left direction keys to move the cursor backward and delete or change the value of the previous digit.
- When using the knob to input, use the direction keys to select the digit you want to edit and rotate the knob to change its value.

## To Set the Output Amplitude

1. Press **Sine** → **Ampl/HiLev** → **Ampl**, to set the amplitude.

The amplitude shown on the screen is the default value when the instrument is powered or the set value beforehand. When changing the function, if the current value is valid for the new waveform, it will be used sequentially. If you want to set the waveform by high Level or Low Level, press **Ampl/HiLev** or **Offset/LoLev** again, switch to **HiLev** or **LoLev** parameter (The current operation is displayed in inverse color).

2. Input the desired Amplitude.

Use the keypad or the knob to input the desired value, choose the unit, and press the corresponding button.

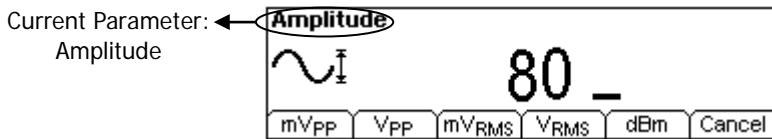

Figure 2-3  
Setting the Amplitude

**NOTE:**

The “dBm” option will appear only when the output impedance is not “High Z”.

## To Set the Offset

1. Press **Sine** → **Offset/LoLev** → **Offset**, to set the offset.

The offset shown on the screen is the default value when the instrument is powered or the set value beforehand. When changing the function, if the current value is valid for the new waveform, it will be used sequentially.

2. Input the desired Offset.

Use the keypad or the knob to input the desired value, choose the unit, and press the corresponding button.

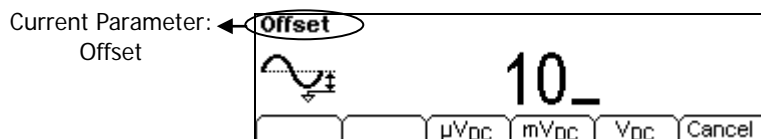

Figure 2-4  
Setting the Offset

## To Set the Initial Phase

1. Press **Sine** → **Phase**, to set the initial phase.

The phase shown on the screen is the default value when the instrument is powered or the set value beforehand. When changing the function, if the current value is valid for the new waveform, it will be used sequentially.

2. Input the desired Phase.

Use the keypad or the knob to input the desired value, choose the unit, and press the corresponding button.

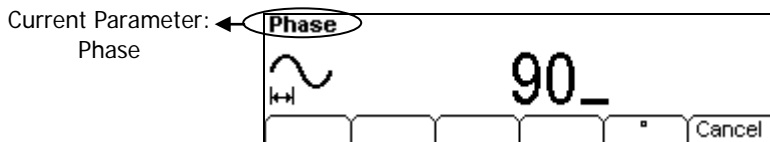

Figure 2-5  
Setting the initial phase

After finishing the above operations, press **View**, in the Graph Mode, the waveform is shown in the following figure.

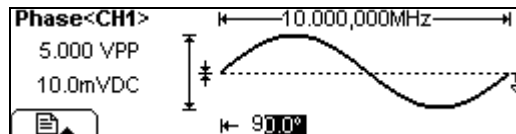

Figure 2-6  
Waveform Parameter in the Graph Mode

## To Set Square Waveform

Press the **Square** button, in the Normal Mode, the operation menu will appear at the bottom of the screen. Set the Square parameters by using the operation menu.

The parameters for Square waveforms are: *Frequency/ Period*, *Amplitude/ High Level*, *Offset/ Low Level*, *Duty Cycle* and *Phase*. See Figure 2-7. In the operation menu, select **DtyCyc**, and the corresponding parameter will be displayed in inverse color for which users can make a change.



Figure 2-7

Square Signal Parameter Setting Interface

Table 2-2 Square Signal Operation Menu

Menu	Settings	Explanation
Frequency/ Period		Setting the signal's frequency or period; the current parameter will switch at a second press.
Amplitude/ High Level		Setting the signal's Amplitude or High Level; the current parameter will switch at a second press.
Offset/Low Level		Setting the signal's Offset or Low Level; the current parameter will switch at a second press
Duty Cycle		Setting the Duty Cycle for Square Waveform
Phase		Setting the initial phase of the signal

**Term Explanation:**

**Duty Cycle:** The percentage that the High Level takes up in the whole Period.

Please Note : for the Frequency                      Duty Cycle Value

Below 3MHz(included):                                      20% to 80%

From 3MHz to 4MHz (included):                                      40% to 60%

From 4MHz to 5MHz (included):                                      50%



## To Set the Duty Cycle

1. Press **Square** → **DtyCyc**, to set the Duty Cycle.

The Duty Cycle shown on the screen is the default value when the instrument is powered or the set value beforehand. When changing the function, if the current value is valid for the new waveform, it will be used sequentially.

2. Input the desired Duty Cycle.

Use the keypad or the knob to input the desired value, choose the unit, and press the corresponding button. The Generator will change the waveform immediately.

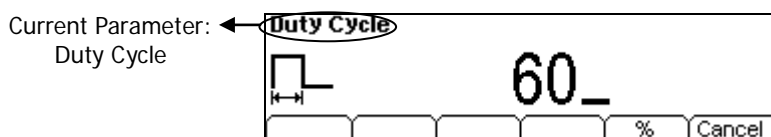

Figure 2-8  
Setting the Duty Cycle

Press **View**, in the Graph Mode, the waveform is shown in the following figure.

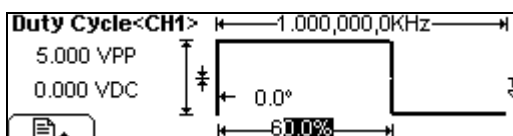

Figure 2-9  
Waveform Parameters in the Graph Mode

## To Set Ramp Waveform

Press the **Ramp** button, in the Normal Mode, the operation menu will appear at the bottom of the screen. Set the Ramp parameters by using the operation menu.

The parameters for Ramp waveforms are: *Frequency/ Period, Amplitude/ High Level, Offset/ Low Level, Symmetry and Phase*. See Figure 2-10. In the operation menu, select **Symm**, and the corresponding parameter will be displayed in inverse color for which users can make a change.



Figure 2-10  
Ramp Signal Parameter Setting Interface

Table 2-3 Ramp Signal Operation Menu

Menu	Settings	Explanation
Frequency/ Period		Setting the signal's frequency or period; the current parameter will switch at a second press.
Amplitude/ High Level		Setting the signal's Amplitude or High Level; the current parameter will switch at a second press.
Offset/Low Level		Setting the signal's Offset or Low Level; the current parameter will switch at a second press
Symmetry		Setting the Symmetry for Ramp Waveform
Phase		Setting the initial phase of the signal

**Term Explanation:**

**Symmetry:** The percentage that the Rising Period takes up in the whole Period.  
Input Range: 0~100%

## To Set the Symmetry

1. Press **Ramp** → **Symm**, to set the Symmetry.  
The Symmetry shown on the screen is the default value when the instrument is powered or the set value beforehand. When changing the function, if the current value is valid for the new waveform, it will be used sequentially.
2. Input the desired Symmetry.  
Use the keypad or the knob to input the desired value, choose the unit, and press the corresponding button. The Generator will change the waveform immediately.

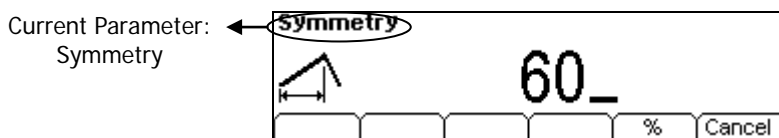

Figure 2-11  
Setting the Symmetry

Press **View**, in the Graph Mode, the waveform is shown in the following figure.

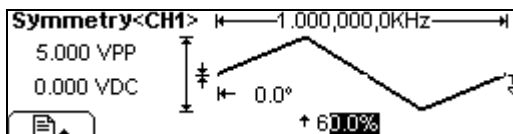

Figure 2-12  
Waveform Parameter in the Graph Mode

## To Set Pulse Waveform

Press the **Pulse** button, in the Normal Mode, the operation menu will appear at the bottom of the screen. Set the Pulse parameters by using the operation menu.

The parameters for Pulse waveforms are: *Frequency/ Period, Amplitude/ High Level, Offset/ Low Level, Pulse Width/ Duty Cycle and Delay*. See Figure 2-13, in the operation menu, select **Width**, and the corresponding parameter will be displayed in inverse color for which users can make a change.



Figure 2-13  
Pulse Signal Parameter Setting Interface

Table 2-4 Pulse Signal Operation Menu

Menu	Settings	Explanation
Frequency/ Period		Setting the Frequency or Period of the signal.
Amplitude/ High Level		Setting the Amplitude or High Level of the signal.
Offset/Low Level		Setting the Offset or Low Level of the signal.
Width/ DtyCyc		Setting the Pulse Width or Duty Cycle of the Pulse Waveform.
Delay		Setting the Delay time.

**Term Explanation:**

**Pulse Width:** The time span between thresholds of 50% of the rising edge amplitude to the next 50% of the falling edge amplitude.

## To Set the Pulse Width

1. Press **Pulse** → **Width**, to set the Pulse Width.

The Pulse Width shown on the screen is the default value when the instrument is powered or the set value beforehand. When changing the function, if the current value is valid for the new waveform, it will be used sequentially.

2. Input the desired Pulse Width.

Use the keypad or the knob to input the desired value, choose the unit, and press the corresponding button. The Generator will change the waveform immediately.

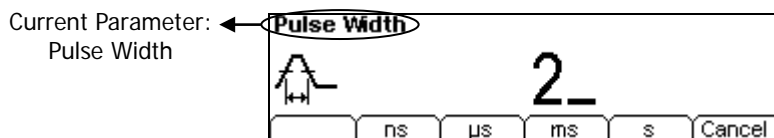

Figure 2-14  
Setting the Pulse Width

### Key Points:

- **Pulse width is limited by the minimum pulse width and the Pulse period.**  
Minimum Pulse width = 20ns  
Pulse width  $\geq$  Minimum Pulse width  
Pulse width  $\leq$  Pulse period – Minimum Pulse width
- **Pulse duty cycle is limited by the minimum pulse width and the Pulse period.**  
Pulse duty cycle  $\geq 100 \times$  Minimum Pulse width  $\div$  Pulse period  
Pulse duty cycle  $\leq 100 \times (1 - \text{Minimum Pulse width} \div \text{Pulse period})$
- **Settings of “Pulse Width” and “Duty Cycle” are equivalent.**  
Once a parameter is changed, the other one will change accordingly. For instance, the current period is 1ms, the pulse width is 500 $\mu$ s and the duty cycle is 50%, when setting the pulse width to be 200 $\mu$ s, the duty cycle will become 20%.
- **About the setting method of “Duty Cycle”, please refer to the introduction about the “Duty Cycle” of the Square.**

## To Set the Pulse Delay

1. Press **Pulse** → **Dela**, to set the Pulse Delay time.  
The Delay time shown on the screen is the default value when the instrument is powered or the set value beforehand.
2. Input the desired Delay time.  
Use the keypad or the knob to input the desired value, choose the unit, and press the corresponding button. The Generator will change the waveform immediately.

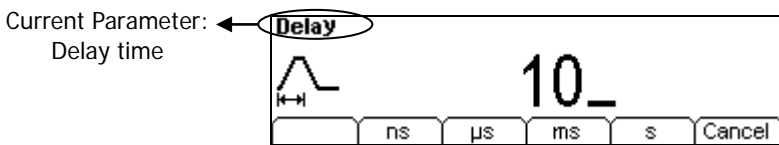

Figure 2-15  
Setting the Delay time

Press **View**, in the Graph Mode, the waveform is shown as in the following figure.

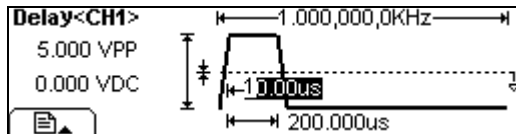

Figure 2-16  
Waveform parameters in the Graph mode

## To Set Noise Waveform

Press the **Noise** button, in the Normal Mode, the operation menu will appear at the bottom of the screen. Set the Noise parameters by using the operation menu.

The parameters for Noise waveforms are: Amplitude/ High Level and Offset/ Low Level. See Figure 2-17, in the operation menu, select **Ampl**, and the corresponding amplitude will be displayed in inverse color for which users can make a change for the amplitude of Noise, which has no frequency or period.

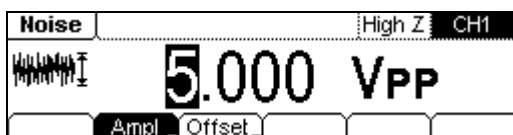

Figure 2-17

Noise Signal Parameter Setting Interface

Table 2-5 Noise Signal Operation Menu

Menu	Settings	Explanation
Amplitude/ High Level		Setting the signal's Amplitude or High Level; the current parameter will switch at a second press.
Offset/Low Level		Setting the signal's Offset or Low Level; the current parameter will switch at a second press

Press **View**, in the Graph Mode, the waveform is shown in the following figure.

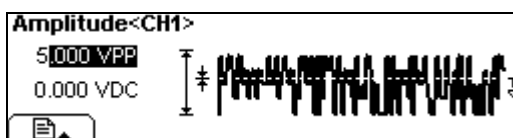

Figure 2-18

Waveform Parameter in the Graph Mode

## To Set Arbitrary Waveforms

Press the **Arb** button, in the Normal Mode, the operation menu will appear at the bottom of the screen. Set the Arbitrary Waveform parameters by using the operation menu.

Arbitrary Signals are divided into two categories: the built-in optional system waveforms and the user-definable arbitrary waveforms. The parameters for Arbitrary Waveforms are: *Frequency/ Period, Amplitude/ High Level, Offset/ Low Level and Phase*. See Figure 2-19, in the operation menu, select **Freq**, and the corresponding frequency will be displayed in inverse color for which users can make a change.

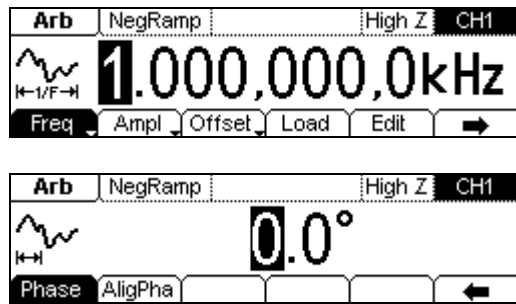

Figure 2-19  
Arbitrary Signal Parameter Setting Interface

Table 2-6 Arbitrary Signal Operation Menu

Menu	Settings	Explanation
Frequency/ Period		Setting the signal's frequency or period; the current parameter will switch at a second press.
Amplitude/ High Level		Setting the signal's Amplitude or High Level; the current parameter will switch at a second press.
Offset/Low Level		Setting the signal's Offset or Low Level; the current parameter will switch at a second press.
Load		Select the built-in Arbitrary Signal as Output.
Edit		Create and Edit Arbitrary Waveform.
Phase		Setting the initial phase of the signal



## To Select Arbitrary Waveform

There are 48 built-in Arbitrary Waveforms and 10 Non-Volatile memories for storing the user-defined Arbitrary Waveforms in the Generator.

Press **Arb** → **Load**, enter the interface shown below.

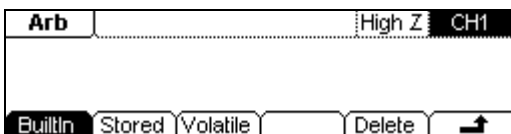

Figure 2-20 Operation Menu

Table 2-7 Selection Menu for Built-in Arbitrary Waveform

Menu	Settings	Explanation
Builtin		Select one of the five built-in Arbitrary Waveforms (See Table 2-8)
Stored		Select one of Arbitrary Waveforms stored in the Non-volatile memory.
Volatile		Select one of Arbitrary Waveforms stored in the Volatile memory. When a new waveform is created, the old one will be erased.
Delete		Delete one of the Arbitrary Waveforms stored in the Non-volatile memory. The five Built-in Waveforms can not be deleted.
↕		Cancel the current operation, and return to the upper menu. (The rest are the same and will not be covered)

### Instructions

- When there is no waveform stored in the Non-Volatile Memory, the **Stored** Menu and the **Delete** Menu will hide.
- When there is no waveform in the Volatile Memory, the **Volatile** menu will hide.

## To Select the Built-in Waveform

Press **Arb** → **Load** → **BuiltIn**, enter the following interface.

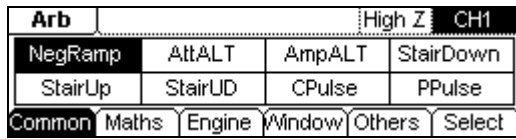

Figure 2-21 Operation Menu

Table 2-8 Built-in Arbitrary Waveforms Menu

Menu	Settings	Explanation
Common	NegRamp/AttALT/AmpALT/StairDown/StairUp/StairUD/CPulse/PPulse/NPulse/Trapezia/RoundHalf/AbsSine/AbsSineHalf/SineTra/SineVer	Choose common Waveforms
Maths	ExpRise/ExpFall/Tan/Cot/Sqrt/X^2/Sinc/Gauss/HaverSine/Lorentz/Dirichlet/GaussPulse/Airy	Choose Math Waveforms
Engine	Cardic/Quake/Gamma/Voice/TV/Combin/BandLimited/StepResp/Butterworth/Chebyshev1/Chebyshev2	Choose Engine Waveforms
Window	Boxcar/Barlett/Triang/Blackman/Hamming/Hanning/Kaiser	Choose Window Waveforms
Others	RounsPM/DC	Choose other Waveforms
Select		Press to select the waveform

As shown in the following figure, Press **Math**, use the knob to choose “ExpRise” and press **Select**. Press **View** to view the waveform of “ExpRise” function.

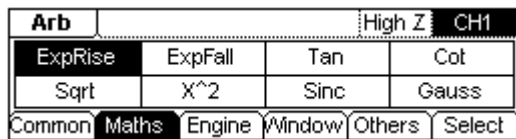

Figure 2-22 Choose “ExpRise” function

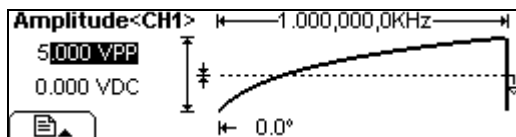

Figure 2-23 Waveform Parameter in the Graph Mode

## To Select the Stored Waveform

Press **Arb** → **Load** → **Stored**, and enter the following interface. Select the desired waveform document which will be displayed in inverse color and press **Recall** to recall it from the memory.



Figure 2-24 Operation Menu

Table 2-9 The Stored Arbitrary Waveform Menu

Menu	Settings	Explanation
Disk	Local	Choose display route for the system information
	U Disk (When U Disk is connected )	
Type	State	Setting of the Generator
	Data	Arbitrary waveform file
	All	All types of documentation
Recall		Recall the waveform or Setting information in the specific position in the memory.
Store		Save the waveform to the appointed place
Remove		Remove any file that has been stored in the memory

## To Edit Arbitrary Waveform

The Generator allows users to edit Arbitrary Waveforms, which can create any new waveform by initializing points. The operation steps are as follows:

Press **Arb** → **Edit**, enter the interface shown below.

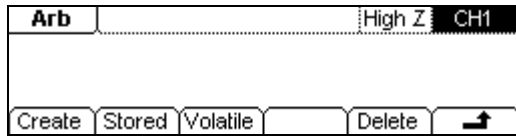

Figure 2-25 Operation Menu

Table 2-10 Waveform Edition Operation Menu

Menu	Settings	Explanation
Create		Create a new waveform, and erase the waveform in the Volatile memory.
Stored		Edit the waveform stored in the non-Volatile memory
Volatile		Edit the waveform stored in the Volatile memory
Delete		Delete one of the Arbitrary Waveforms stored in the Non-volatile memory. But The five Built-in Waveforms can not be deleted.

### Instructions

- When there is no waveform stored in the Non-Volatile Memory, the **Stored** Menu and the **Delete** Menu will hide.
- When there is no waveform in the Volatile Memory, the **Volatile** menu will hide.

## To Create a New Waveform

Press **Arb** → **Edit** → **Create**, to set the overall parameters for the waveform. The setting interface is shown in the following Figure.

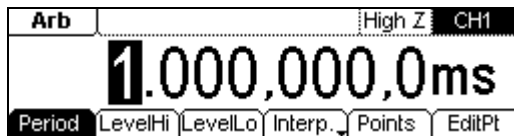

Figure 2-26

Interface for setting the new waveform parameters

Table 2-11 Setting the parameters for the new waveform

Menu	Settings	Explanation
Period		Setting the Period for the Waveform
LevelHi		Setting the Level High for the Waveform
LevelLo		Setting the Level Low for the Waveform
Interp On/ Off		Activate the linear Interpolation between the defined points Deactivate the linear Interpolation between the defined points
Points		Set the number of points when Initializing the waveform
EditPt		Start the Waveform Editor

### 1. To Set the Point Number

- Press **Points**, set the number of the initializing points.

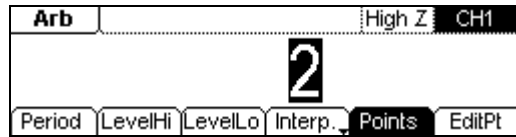

Figure 2-27  
Set the points of the editing waveform

- When a new waveform is created, the waveform editor will firstly create a waveform with two points. The Waveform Editor connects the last point to the Voltage Level of point #1 to create a continuous waveform automatically. A waveform with at most 4K points can be created.
- In the default setting, point #1 is Level High, fixed on 0 second, while point #2 is Level Low and on the half of the set Cycle period.

### 2. To Set the Interpolation

Press **Interp.**, if you choose **Interpolation On**, and the points will be connected with beelines; otherwise, the voltages between the two consecutive points will not change and the waveform looks like a step-up one.

### 3. To Edit the Waveform Points

Press **Arb** → **Edit** → **Create** → **EditPt**, The waveform can be defined by setting the time and voltage for each point using this function. The interface is as follows:

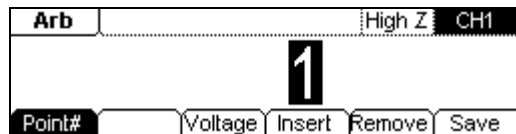

Figure 2-28  
Operation Menu



Figure 2-29  
To Set the voltage

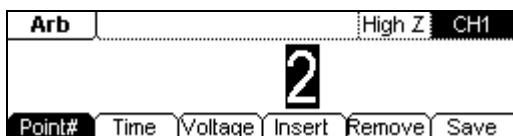

Figure 2-30  
To Edit the Second Point

Table 2-12 Waveform Parameter Edition Menu

Menu	Settings	Explanation
Point#		Select the point to be edited
Time		Set time for the Selected point
Voltage		Set Voltage for the Selected point
Insert		Insert a new point between the defined points. Use the "Time" and "Voltage" to define the new point.
Remove		Remove the current point
Save		Save the created waveform to the non-Volatile Memory.

### Instructions

The time for the last definable point should be less than the cycle period in the waveform.

**4. Save the Waveform to the Non-Volatile Memory**

Press **Arb** → **Edit** → **Create** → **EditPt** → **Save**, enter the following interface. Select the desired location (ARB1~ARB10) used to save, which will be displayed in inverse color and press **Store** to save it to the specific place.



Figure 2-31  
Operation Menu

**Instructions**

**To save the Arbitrary Waveform:**

In the Non-volatile Memory, each waveform storage place can only save one waveform. If a new one is stored, the old one will be erased.

After the storage, press **Recall** to read the waveform to volatile memory. Press **View**, the edited waveform is shown in the following figure.

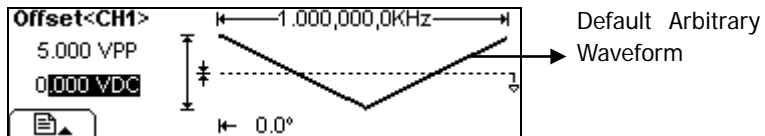

Figure 2-32  
Waveform under the Graph Mode



## To Edit the Stored Waveform

Press **Arb** → **Edit** → **Stored**, enter the following interface.



Figure 2-33

Select the waveform to edit

Select the desired waveform document to edit, which will be displayed in inverse color and press **Recall** to recall and edit it in the Volatile memory. As shown in the following figures, users can edit the parameters as in need and store it after the modification.

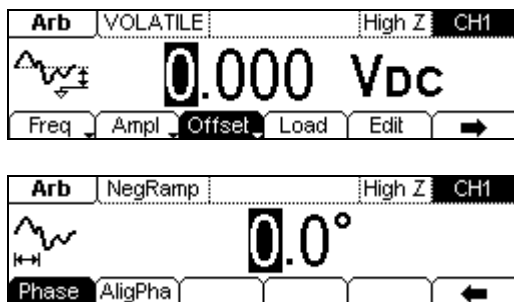

Figure 2-34

Edit the waveform parameters

## To Set Modulated Waveforms

Use the **Mod** button to generate modulated waveform. DG1000 can generate AM, FM, FSK, PM modulated waveforms. The modulation parameters should be set in different types of modulation.

- In AM, users can set the Source (Internal/ External), depth, Modulating Frequency, Modulating Waveform and Carrier Waveform;
- In FM, users can set the Source (Internal/ External), Frequency Deviation, Modulating Waveform and Carrier Waveform;
- In FSK, users can set the Source (Internal/ External), HopFreq, FSK Rate, and Carrier Waveform;
- In PM, users can set the Source (Internal/ External), Phase Deviation, Modulating Frequency, Modulating Waveform and Carrier Waveform.

We will introduce how to set these parameters in details according to different types of modulation.

## To Set AM Waveform

The modulated waveform consists of two parts: the Carrier Waveform and the Modulating Waveform. In AM, the Amplitude of the Carrier Waveform varies with the instantaneous voltage of the modulating waveform.

Carrier Waveform used in AM can be set through the **Sine**, **Square**, **Ramp**, **Arb** button on the front panel.

Press **Mod** → **Type** → **AM**, enter the following interface.



Figure 2-35

Modulated Waveform Parameters Interface for AM

Table 2-13 Setting the AM parameters

Menu	Settings	Explanation
Type	AM	Choose Amplitude Modulation
SrcInt	Depth	Set the amplitude range (0%~120%)
	AMFreq	Set the modulating waveform frequency (2mHz~20kHz)
	Shape	Choose internal modulating Waveform: Sine Square Triangle UpRamp DnRamp Noise Arb
SrcExt		Choose External modulation, the modulating waveform is inputted from the [Modulation In] port on the rear panel.

In the Graph Mode, the waveform is shown in the following figure.

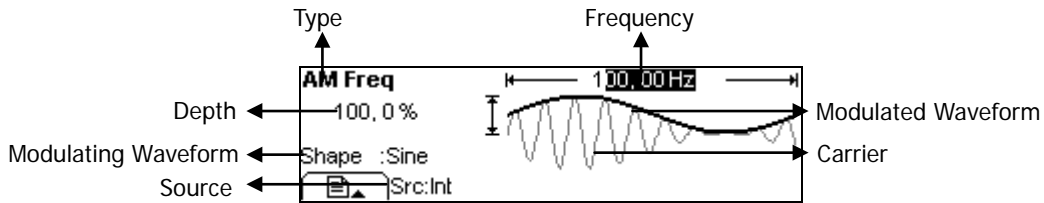

Figure 2-36  
Waveform Parameter in the Graph Mode

### Term Explanation

#### Modulation Depth

The Amplitude Range (also called “Percentage Modulation”). Modulation Depth varies from 0% to 120%.

- In the 0% Modulation, the output amplitude is the half of the set one.
- In the 100% Modulation, the output amplitude is the same with the set one.
- When the modulation is greater than 100%, the instrument output not greater than 20 V<sub>PP</sub>.
- For an external source, the depth of AM is controlled by the voltage level of the connector connected to the [Modulation In]. +5V external source corresponds to the 100% internal Modulation.

## To Set FM Waveform

The modulated waveform consists of two parts: the Carrier Waveform and the Modulating Waveform. In FM, the Frequency of the Carrier Waveform varies with the instantaneous voltage of the modulating waveform.

Carrier Waveform used in FM can be set through the **Sine**, **Square**, **Ramp**, **Arb** button on the front panel.

Press **Mod** → **Type** → **FM**, enter the following interface.



Figure 2-37

FM Waveform Parameter Setting Interface

Table 2-14 Setting the FM parameters

Menu	Settings	Explanation
Type	FM	Choose Frequency Modulation
SrcInt	Deviat.	Set the Frequency Deviation between the Modulating Waveform and the Carrier Waveform.
	FMFreq	Set the modulating waveform frequency (2mHz~20kHz)
	Shape	Choose internal modulating Waveform: Sine Square Triangle UpRamp DnRamp Noise Arb
SrcExt	Deviat.	Choose External modulation, the modulating waveform is inputted form the [Modulation In] port on the rear panel. Only "Deviat." needs to be set.

In the Graph Mode, the waveform is shown as in the following figure.

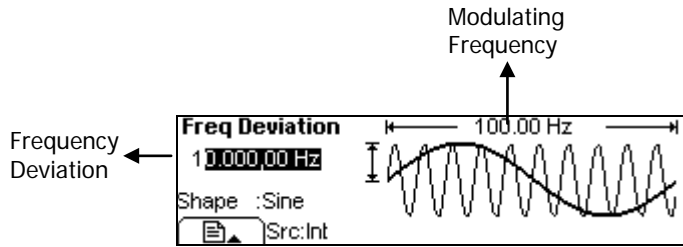

Figure 2-38  
Waveform Parameter in the Graph Mode

### Term Explanation

#### Frequency Deviation

- The Deviation should be equal to or less than the Carrier Waveform Frequency.
- The Sum of the Deviation and the Carrier Frequency should be equal to or less than maximum frequency of the selected function plus 1kHz.
- For an External Source, the Deviation is controlled by the  $\pm 5V$  voltage Level of the Connector connected to the [Modulation In]. +5V corresponds to the selected Deviation. Lower external voltage generates less deviation, while negative voltage reduces the modulated signal frequency to below the corresponding carrier's.

## To Set FSK Waveform

The FSK Modulation is a modulation method, the output frequency of which switches between the two pre-set frequencies (Carrier Waveform Frequency and the Hop Frequency). The Output Frequency which shifts from the carrier frequency to the Hop frequency is called the FSK rate. The frequency by which the output frequency switch from each other is determined by the Internal Frequency generator or the Signal Voltage Level offered by the [Ext Trig/FSK/Burst] connector on the rear panel.

- If you choose the Internal Modulation, the frequency at which the output frequency shift between the carrier frequency and the Hop frequency is determined by the set FSK rate.
- If you choose External Modulation and overlook the FSK rate, the output frequency is determined by the Voltage Level of the [Ext Trig/FSK/Burst] connector on the rear panel. If the Voltage Level is Low, then generate the carrier frequency; when the voltage level is high, generate the Hop frequency.

Carrier Waveform used in FSK can be set through the **Sine**, **Square**, **Ramp**, **Arb** button on the front panel.

Press **Mod** → **Type** → **FSK**, enter the following interface.



Figure 2-39  
FSK Waveform Parameter Setting Interface

Table 2-15 Setting the FSK parameters

Menu	Settings	Explanation
Type	FSK	Choose Frequency Shift Keying Modulation
SrcInt	HopFreq	Set the Hop Frequency Range (Internal Source: Square with 50% duty cycle)
	FSK Rate	Set the frequency at which the output frequency shifts between the carrier frequency and the jumping frequency: 2mHz~50kHz.
SrcExt	HopFreq	Choose External modulation, the modulating waveform is inputted form the [Ext Trig/FSK/Burst] port on the rear panel. Only "HopFreq" needs to be set.

Press **View**, in the Graph Mode, the waveform is shown in the following figure.

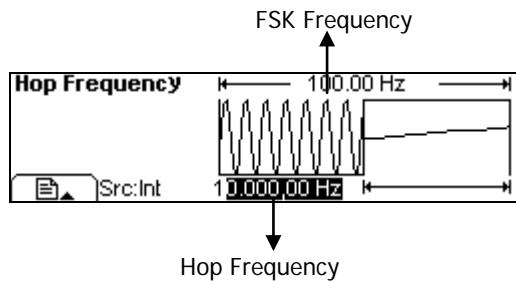

Figure 2-40  
Waveform Parameter in the Graph Mode



## To Set PM Waveform

The modulated waveform consists of two parts: the Carrier Waveform and the Modulating Waveform. In PM, the Phase of the Carrier Waveform varies with the instantaneous voltage Level of the modulating waveform.

Carrier Waveform used in PM can be set through the **Sine**, **Square**, **Ramp**, **Arb** button on the front panel.

Press **Mod** → **Type** → **PM**, enter the following interface.

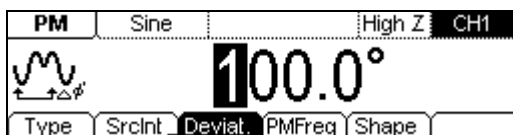

Figure 2-41

PM Waveform Parameter Setting Interface

Table 2-16 Setting the PM parameters

Menu	Settings	Explanation
Type	PM	Choose Phase Modulation
SrcInt	Deviat.	Set the Phase Deviation between the Modulating Waveform and the Carrier Waveform ( $0^{\circ} \sim 360^{\circ}$ )
	PMFreq	Set the modulating waveform frequency (2mHz~20kHz)
	Shape	Choose internal modulating Waveform: Sine Square Triangle UpRamp DnRamp Noise Arb
SrcExt	Deviat.	Choose External modulation, the modulating waveform is inputted form the [Modulation In] port on the rear panel. Only "Deviat." needs to be set.

Press **View**, in the Graph Mode, the waveform is shown in the following figure.

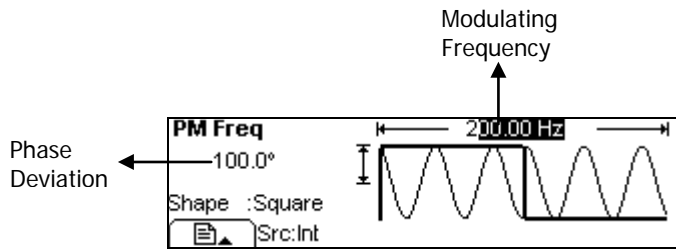

Figure 2-42  
Waveform Parameter in the Graph Mode

## To Generate Sweep Signal

In the frequency sweep mode, the function generator “sweep” from the start frequency to the stop frequency at the sweep rate you specify. Sweeping can be generated by Sine, Square, Ramp or Arbitrary Waveforms (Pulse, Noise and DC are not allowed).

Press the **Sweep** button, in the Normal Mode, the operation menu will appear on the bottom of the screen. See Figure 2-43, set the Waveform parameters by using the operation menu.



Figure 2-43

### Sweep Waveform Parameter Setting Interface

Table 2-17 Waveform Sweep Setting Menu

Menu	Settings	Explanation
Linear log	/	Set the Sweep with linear spacing Set the Sweep with logarithmic spacing
	/	Set the Start Frequency of the Sweep Set the Center Frequency of the Sweep
Start Center	/	Set the Stop Frequency of the Sweep Set the Frequency Span of the Sweep
	/	Set the Time Span of the Sweep for which the Frequency changes from the Start Frequency to Stop Frequency.
Stop Span	/	Int: Choose Internal Source Ext: Choose External Source, use the [Ext Trig/FSK/Burst] connector on the rear panel Manual: Choose manual trigger. Press <b>Manual</b> will trigger a Sweep.
	Source	↗ : Signal Triggered at Rise Edge ↘ : Signal Triggered at Fall Edge Off: Turn off Trigger Setting
Time	TrigOut	↗ : Signal Triggered at Rise Edge ↘ : Signal Triggered at Fall Edge Off: Turn off Trigger Setting
	↗	Finish trigger settings

## Sweep Frequency Setting

Use **Start** and **Stop** or **Center** and **Span** to set the range of the frequency. Press the button again to switch to each other.

- To Sweep upward, set the Start Frequency lower than the Stop Frequency, or set a positive frequency interval.
- To Sweep downward, set the Start Frequency higher than the Stop Frequency, or set a negative frequency interval.

### **Instructions**

Possible changes or varies to the amplitude characteristic of output signal may happen while sweep frequency on a large scale.

## To Generate Burst Signal

Burst Function can generate versatile waveforms in burst, which can last specific times of waveform cycle(N-Cycle Burst), or when the external gated signals (Gated Burst) is applied, any waveform could be used, but noise can only be used in Gated Burst.

Press the **Burst** button, in the Normal Mode, the operation menu will appear on the screen, see Figure 2-44. Set the Waveform parameters by using the operation menu.

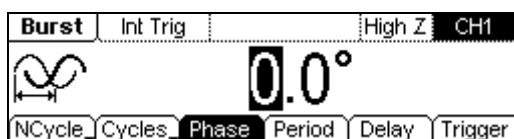

Figure 2-44

Burst Waveform Parameter Setting Interface

## Set the N-Cycle Burst

Press **Burst** → **NCycle**, enter the following interface.

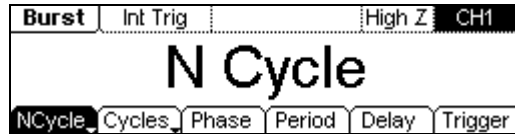

Figure 2-45  
Operation Menu

Table 2-18 Setting the N-Cycle parameters

Menu	Settings	Explanation
N-Cycle Gated		Use the N-Cycle Mode Use the Gated Mode
Cycles Infinite		Set the Number of the bursts in a N-Cycle Set the Number of the bursts in a N-Cycle to be infinite
Phase		Set the Start Phase of the Burst
Period		Set the Period of the Burst
Delay		Set the Delay for the burst
Trigger	Source	Int: Choose Internal Source Ext: Choose External Source, use the [Ext Trig/FSK/Burst] connector in the rear panel Manual: Choose manual trigger. Press Manual will output a burst signal
	TrigOut	↗ : Signal Triggered at Rise Edge ↘ : Signal Triggered at Fall Edge Off: Turn off Trigger Setting
	↗	Finish trigger settings

### 1. N-Cycle/ Gated

N-Cycle has specific number of waveform cycles, and every burst is activated by a trigger event. Gated burst use external source to control burst when to be activated.

### 2. Cycle Number

Set the number of Waveform Cycle in an N-Cycle (1 to 50,000 or Infinite).

If you choose **Infinite**, then a continuous waveform will be generated.

- If needed, Burst Period will increase to cater to the specific number of cycles.
- For an infinite-cycle Burst, External or Manual Trigger is needed to activate burst. For Manual Trigger, a trigger will be generated for the first time when you press **Manual** and stop after the second press.

### 3. Phase

Define the Start and the Stop Point in a waveform. The phase varies from  $-180^\circ$  to  $+180^\circ$ , and the default setting is  $0^\circ$ . For an Arbitrary Waveform,  $0^\circ$  is the phase of the first waveform point.

### 4. Period

Set the time span between an N-Cycle Burst to the next. If necessary the period will increase to allow the specific number of cycles in a burst.

Burst Period > Period X Burst Number

### 5. Delay

Set the Time Delay between the Trigger Input and the Start of the N-Cycle Burst. The delay should be greater than (or equal to) 0 and less than the specific burst period.

Press **View**, in the Graph Mode, the waveform is shown in the following figure.

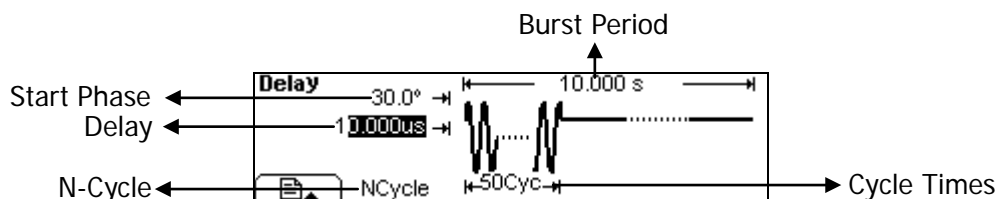

Figure 2-46

Waveform Parameter in the Graph Mode

## Set the Gated Burst

Press **Burst** → **Gated**, enter the following interface.



Figure 2-47  
Operation Menu

Table 2-19 Setting the Gated parameters

Menu	Settings	Explanation
NCycle Gated		Set the Gated Mode
Polarity	Pos Neg	Set the Polarity for the Gated Signal
Phase		Set the Start Phase for the Gated Signal

Press **View**, in the Graph Mode, the waveform is shown in Figure 2-48.

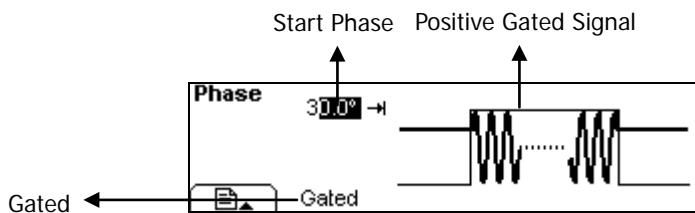

Figure 2-48  
Waveform Parameter in the Graph Mode



## To Store and Recall

Press the **Store/Recall** Button, and the operation menu will appear at the bottom of the screen. You can save or read the State or Data Documentation inside the Generator or build and delete documentation in the U Disk. File names can either be Chinese or English.



Figure 2-49  
Save and Read Interface

Table 2-20 Save and Read Menu

Menu	Settings	Explanation
Disk	Local	Choose display route for the system information
	U Disk (When U Disk is connected)	
Type	State	Can store 10 States
	Data	Can store 10 Waveforms
	All	All types of documentation
Recall		Recall the waveform or Setting information in the specific position in the memory.
Store		Save the waveform or setting to the appointed place.
Remove		Remove any file that has been stored in the memory

## To Save the Instrument State

Users are allowed to store the instrument state on any of the 10 Non-Volatile Memories. The state storage will "memorize" the selected function (including the Arbitrary Waveform), Frequency, Amplitude, DC Offset, Phase, Duty Cycle, Symmetry, and other modulation parameter used.

To Save the Instrument State, following the steps:

- (1) Choose the file Type to store

Press **Store/Recall** → **State**, and choose the storage type to be "State".

- (2) Choose the location of the file.

There are ten positions in the Local STATE1, STATE2.....STATE10, choose one of them by rotating the knob.

- (3) Name the file and Save it

Press **Store** button, enter the desired name. Press **Store** to finish.

## To Save Data

Users are allowed to store data document in any of the 10 Non-Volatile Memories. If the place is already occupied, the new document will cover the old one. To save the data, following the steps:

- (1) Choose the file Type to store  
Press **Store/Recall** → **data**, and choose "data" as the storage type.
- (2) Choose the location of the file.  
There are ten positions in the Local ARB1, ARB2.....ARB10, choose one of them by rotating the knob.
- (3) Name the file and Save  
Press **Store** button, enter the desired name. Press **Store** to finish.

## To Use USB storage

As shown in Figure 2-50, the storage location is divided into: the inherent Local storage and the USB storage. At the left side of the front panel, there is a USB interface. When USB flash drive is connected, the storage menu will show "U Disk". Otherwise, the default location is the internal location Local.



Figure 2-50  
To use the USB Storage

### (1) Install the USB flash drive

Insert the mobile memory to the USB interface on the front panel, and the screen will show "↕".

### (2) Choose the USB Disk

Press **Disk**, move the cursor upward or downward to select "U Disk". Choose "Data" or "State" and press **Store**. Enter the file name and then press **Store** to save the file.

### (3) Uninstall the USB flash drive

Remove the USB flash drive, the "↕" Sign will disappear.

### To Save a File

Press **Store/Recall** → **Store**, enter the following interface. Enter the desired file name in the "File Name" frame. Under the frame is the input keypad. Use the direction keys and the knob to select the desired character. When the character is in inverse color, press **Select** to input it.



Figure 2-51  
File Storage Interface

Table 2-21 File Storage Menu

Menu	Settings	Explanation
Lang	EN	English Input
	CN	Chinese Input
Select		Select the current character
Remove		Delete the current character
Store		Store the file with the current name
		Cancel the current operation

## 1. English Input

- The English Input Interface is shown in the following figure, to save a file named as "NewFile", following the steps below.

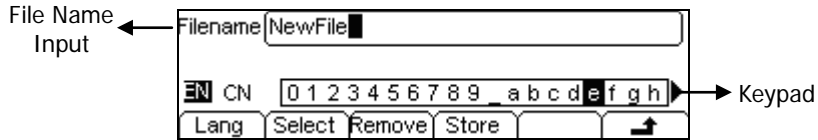

Figure 2-52  
English Input Interface

- (1) Press **Lang** → **EN**, enter the English Interface.
- (2) Input the file name "NewFile".  
Use the Knob to adjust the cursor to the right character, and press **Select**. Repeat this until you have selected all the characters needed. Press **+/-** to choose the majuscule or lowercase.
- (3) Edit the File Name  
When you have entered a wrong character, move the cursor to the wrong character and press **Remove** to delete it. And then enter the file name again.
- (4) Press **Store** to finish and save the file.

## 2. Chinese Input

- The Chinese Input Interface is shown in the following figure. To save a new file, follow the instructions below:



Figure 2-53  
Chinese Input Interface

- (1) Press **Lang** → **CN**, enter the Chinese Input Interface.
- (2) Press "**+/-**" to choose the lowercase, and input the spell of the Chinese.
- (3) Input the file name: "新文件"  
Use the Knob to adjust the cursor to the right character, and press **Select**. Input "Xin". In the Input Menu, choose the Chinese character you need with the help of the page controller and the 1~9 button on the keypad.
- (4) Edit the wrong input  
When a file name is wrong, move the cursor to the character and press **Remove** to delete it and enter the file name again.
- (5) Press **Store** to finish and save the file.

## To Set the Utility Function

With the **Utility** Function, you can set the Sync On/Off, Channel Output Parameters, Channel Coupling, Channel Copy, Counter Measurement, Interface Parameter, System Setting and Test/Cal Parameter.

- Sync switch offers the option to choose the Sync Signal or not.
- The Channel Output parameters provide the parameter setting for Load/Impedance, Normal/ Invert.
- Channel Coupling provides Frequency/Phase coupling of the two channels.
- Channel Copy provides parameter copy of the two channels.
- Counter provides Frequency measurement function.
- The Interface Parameter offers USB serial-number viewing.
- The System Setting provides the setting for Language, Display, Beep, Screen Guard, Format, Power System Configure, Default and Timer setting.
- The Test/Cal Parameter provides the self-testing and calibration storage as well as the password and safety switch.



Press the **Utility** button, enter the following interface (two pages):

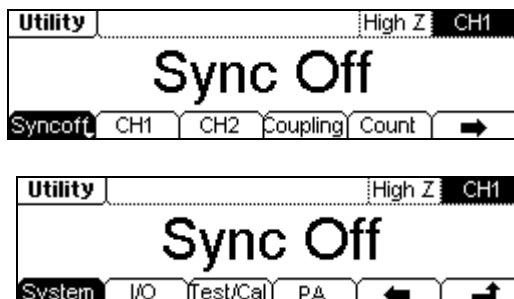

Figure 2-54  
Utility Settings Interface

Table 2-22 Utility System Setting

Menu	Settings	Explanation
Sync On Sync Off	On Off	Enable/disable the Sync Signal of CH1 through the [Sync Out] connector on the rear panel.
CH1	/	Basic Setting of CH1: Impedance, Normal/Invert display
CH2	/	Basic Setting of CH2: Impedance, Normal/Invert display
Coupling	/	Settings of Channel Coupling and Channel Copy
Count	/	Frequency Measurement in single channel. Range: 100mHz~200MHz
➡	/	Go to the next page of menus
System	/	Set the System Configuration
I/O	/	View the USB Information
Test/Cal	/	Do self-test and calibration operation or view the instrument information.
PA	/	Setup power amplifier
⬅	/	Back to the previous page of menus
⬆	/	Save all the settings and exit

**Instructions**

**Sync Switch Setting:**

When the amplitude is low relatively, you can reduce the distortion when output the signal by prohibiting the Sync Signal. And the current storage is in the Non-Volatile Memory.

## To Set the Sync Output

The Generator provides Sync signal output of CH1 through the [Sync Out] Connector on the Rear Panel. All the standard output functions (except DC and Noise) have a corresponding Sync Signal. For some Sync applications, they can be prohibited if users do not want to use them.

- In the default setting, the Sync Signal output is disabled. The output Voltage of the [Sync Out] Connector Level is Low.
- In the Invert mode, the waveform that corresponds to the Sync signal does not Inverse.
- If frequency of the standard output function (except DC and Noise) is higher than 2MHz, the Sync output will automatically turn off.
- For Sine, Square, Ramp and Pulse Signal, the Sync Signal is a Square Signal with 50% Duty Cycle. When the output is positive, The Sync Signal is TTL Level High compared to 0 V Voltage or DC Offset; when the output is negative, The Sync Signal is TTL Level Low compared to 0 V Voltage or DC Offset.
- For Arbitrary Waveform, the Sync Signal is a Square Waveform with 50% Duty Cycle. At the time when the first output waveform point is generated, the Sync Signal Voltage is TTL Level High.
- For the internal Modulating of AM, FM and PM, the Sync Signal reference is the Modulated Signal (not the Carrier Signal). The Sync Signal is a Square Waveform with 50% Duty Cycle. In the first half modulation period, the Sync Signal is TTL Level High. For External Modulation, the Sync Signal reference is the Carrier Signal (not the Modulated Signal). The Sync Signal is also a Square Waveform with 50% Duty Cycle.
- For FSK, the Sync Signal Reference is the Hop Frequency, and the Sync Signal is a Square Waveform with 50% Duty Cycle. For the Hop Frequency, at the hopping point, the Sync Signal is TTL Level High.
- For the Burst, when the burst starts, the Sync Signal is Level High. At the specific point when the Cycle Number ends, the Sync Signal turns Level Low (If the

Waveform has a relative starting phase, it may be not intersection). For an infinite burst, the Sync Signal is the same as the Sync Signal of the continuous Signal.

- For the External Gated Burst, the Sync Signal follows the External Gated Signal. But, please note that this signal will not turn Level Low until the last period end (If the Waveform has a relative starting phase, it may be not intersection).

## Basic Setting of the Two Channels

The following Part will take Channel 1 for example to introduce the basic setting of the two channels.

Press **Utility** → **CH1**, enter the following interface.

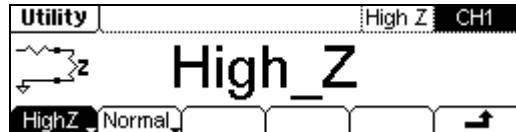

Figure 2-55  
Setting interface of CH1

Table 2-23 Channel Setting Interface

Menu	Settings	Explanation
Load High Z		Set the value of the Load connected to the <b>Output</b> Connector. Set the Load connected to the <b>Output</b> Connector to be High Z.
Normal Invert		Normal Output Invert Output

## 1. To Set the Output Load

For the [Output] Connector on the Front panel, the Generator has a  $50\Omega$  series output impedance. If the actual load does not match the set one, the amplitude and offset displayed are incorrect. This function is used to match the displayed voltage with the expected one.

Steps for setting the load value:

- (1) Press **Utility** → **CH1** → **Load**, enter the following interface.

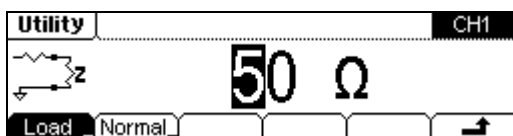

Figure 2-56  
Load Value Setting Interface

Please note that the Load Parameter shown on the right bottom is the default setting when the power is on or the pre-set load value. If the current value is valid for the output, then the current value can be used.

- (2) Input the desired Load Value.

Use the Keypad to enter the desired value and choose the unit,  $\Omega$  or  $K\Omega$ , press the corresponding button.

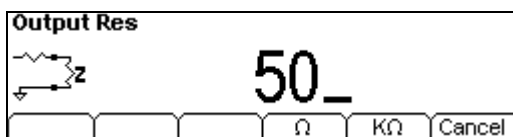

Figure 2-57  
Change the Load Value

## 2. To Set the Inverse Waveform

Press **Utility** → **CH1** → **Invert**, to set the inverse Waveform output. An inverse waveform will be displayed in the Graph Mode.

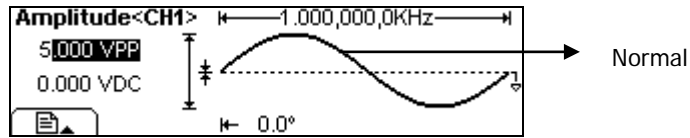

Figure 2-58  
Normal Waveform

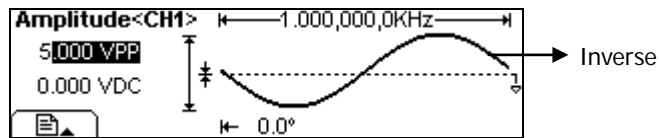

Figure 2-59  
Inverse Waveform

**NOTE:**

No offset voltage will change while the waveform is inverted and the sync signal would also not invert.

## Channel Coupling Settings

Press **Utility** → **Coupling**, enter the following interface.



Figure 2-60  
Channel Coupling Setting Interface

Table 2-24 Channel Coupling Setting Menu

Menu	Settings	Explanation
Switch	Coupling On Coupling Off	Open or close the Coupling function
BaseCH	Channel_1 Channel_2	Choose CH1 or CH2 as the base source in coupling
FreDev PhaDev		Set the frequency deviation between the two channels. Set the phase deviation between the two channels.
CopyCH	1 → 2 2 → 1	Copy the parameters from CH1 to CH2 Copy the parameters from CH2 to CH1
↵		Save the setting and exit

### Key Points:

#### 1. Channel Coupling

- (1) The coupling is only used for frequency and phase, as shown in the following figure, the base channel will mark with a "\*" sign on the screen. It indicates that CH1 has coupling in the phase parameter.

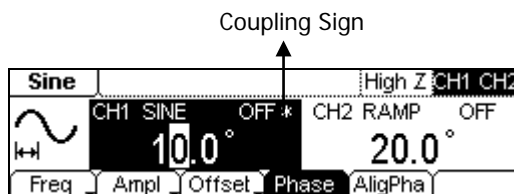

Figure 2-61  
Coupling Sign Instruction

- (2) Only frequency or phase can be coupled each time, it depends on the current selection is **FreDev** or **PhaDev**.

## 2. Channel Copy

- (1) Only when the coupling is closed, the **Copy** menu would appear.
- (2) Only parameters will be copied in the channel copy operation.
- (3) Channel copy is limited by parameters inspection.
- **Frequency limitation**  
Different waveforms have different upper/lower limits of the frequency. When waveforms in the two channels are different, the highest frequency can be copied depends on the waveform which has lower frequency. For instance, a Sine waveform of 5MHz can not be copy to a Ramp (frequency upper limit is 150 KHz).
  - **limitation of the Amplitude and Output impedance setting**  
The upper/lower limits of Amplitude are different in different channels and modes. Before copying, the Output impedance setting of the two channels should be the same. Take CH1 for example, to set the Output impedance, press **Utility** → **CH1** → **Load/High Z**, then set the value in need.
  - **Channel inverting limitation**  
If a channel has been set to **Invert**, after the copying, the two channels will still have 180° phase deviation though the "Phase" parameter has been copied.



## To Set the Counter

The counter can automatically detect signal with amplitude from 200mV<sub>PP</sub> to 5V<sub>PP</sub> and frequency form 100mHz to 200MHz.

Press **Utility** → **Count**, the screen will display the operation menu of the counter, see Figure 2-62. Press “**Freq**”, “**Period**”, “**DutyCyc**”, “**PWidth/NWidth**”, the instrument will display the measured values of the frequency, period, duty cycle, positive width and negative width.

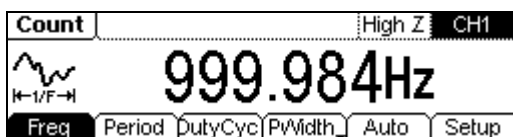

Figure 2-62

Normal display interface of the counter

Table 2-25 Operation menu of the counter

Menu	Settings	Explanation
Freq		Display the frequency of the signal to be measure
Period		Display the period of the signal to be measure
DutyCyc		Display the duty cycle of the signal to be measure
PWidth NWidth		Display the positive width and negative width of the signal to be measure
Auto		Set the measurement parameters of the counter automatically.
Setup		Set the measurement parameters of the counter manually.

Press **Setup** to set the measurement parameters of the counter containing: AC or DC, Sensitivity, Trig Level, High frequency restrain “On” or “Off”. Different settings make different measurement results.

**Instructions**

The data shown on the screen will be refurbished periodically if input frequency signal from external, or which will be stopped refurbishing as soon as you cut off input and last frequency value will be displayed.

## Auto Measurement Setting

Press **Utility** → **Count** → **Auto**, the instrument will set the measurement parameters: Coupling mode, Sensitivity, Trig Level and High Frequency Restrain "On" or "Off".

## Manual Measurement Setting

Press **Utility** → **Count** → **Setup**, enter the manual measurement mode.

### 1. To Set the Coupling Mode

Press **Count** → **Setup** → **DC/AC**, set the coupling mode.

As shown in the following figure, the soft key with "DC" or "AC" is the current coupling mode, each time you press the key, the coupling mode will change. For example, the current mode is "AC", press the key, then the mode will be "DC".



Figure 2-63

To set the coupling mode

### 2. To Set the Sensitivity

The sensitivity has three kinds: High, Medium and Low. Press **Utility** → **Count** → **Setup** → **Sens** to set the sensitivity. Press the corresponding soft key to switch the Sensitivity.



Figure 2-64

To set the sensitivity

### Suggestion:

- For low amplitude signal, the "medium" or "high" sensitivity should be used.
- For low frequency signal with high amplitude and slower rising edge, low sensitivity is a better choice.

### 3. To Set the Trig Level

The trig level (-3V~+3V) is divided into 1000 (00.0~99.9) shares, each "0.1" is 6 mV, it means the adjustment interval is 6 mV. For example, the input is "62.0", then the trig level is:  $-3V + (62.0 / 0.1) \times 6 \text{ mV} = 0.72V$ .

- (1) Press **Utility** → **Count** → **Setup** → **TrigLev** to set the trig level.

The trig level display on the screen is the default value when power on or the value set at the last time. If the current value is effective, it could be use immediately.

- (2) Input the required trig level.

Use the knob to change the value as shown in the following figure, the counter will immediately adjust the trig level, and trigger according to the specified value.

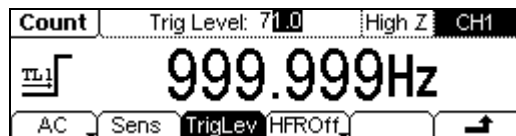

Figure 2-65  
To set the trig level

**NOTE:** In DC coupling mode, users need to adjust the trig level manually.

#### 4. To Set the High Frequency Restrain On/Off

High frequency restrain is used for filtering the high frequency signal in measuring the low frequency signal, and improve the measure accuracy.

Press **Utility** → **Count** → **Setup** → **HFR On/Off** to set the high frequency restrain to be on or off. See Figure 2-66, the soft key of "HFR On" or "HFR Off" is the current state, each time you press the key, the state will change to another one.



Figure 2-66  
To set the high frequency on/off

#### Suggestion:

- To measure low frequency signal lower than 1kHz, you should put on the high frequency restrain to filter the high frequency noise disturb.
- To measure high frequency signal higher than 1kHz, you should put off the high frequency restrain.

## System Settings

Press **Utility** → **→** → **System**, enter the following interface.



Figure 2-67  
Operation Menu

Table 2-26 System Setting Menu

Menu	Settings	Explanation
Lang		Set the Display Language
Display		Set the parameter for the Screen Display
Beep On/Off	On	Open Beep
	Off	Close Beep
Svr on/off	On	Activate the Screen Guard Program. Screen Guard will be on if no action is taken within 3 minutes. Press any button to resume.
	Off	deactivate the Screen Guard Program
Format		Set the data format
Setting	PowOn	Default: When the power is on, all the setting will return to the default value. Latest: When the power is on, all the setting will return to the latest setting.
	Default	Return all the setting into the default one
	Timer	Choose the clock source as: internal/external

**Key points:****Power On**

- The Setting is used when the machine is power on.
- Two choices are available: the default setting and the latest. Once selected, the setting will be used when the instrument is restarted.

**Beep**

- Activate or deactivate the sound when an error occurs from the front panel or the remote interface.
- Activate or deactivate any sound made by the button or knob on the front panel.

## 1. Language Setting

DG1000 series Generator offers two languages: Chinese and English. To Select Language, press **Utility** → **System** → **Lang**, change the language.



Figure 2-68  
Language Setting Menu

## 2. Display Control

Press **Utility** → **System** → **Display**, enter the following menu.

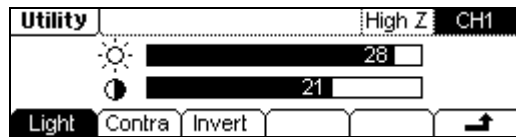

Figure 2-69  
Operation Menu

Table 2-27 Display Parameter Setting

Menu	Settings	Explanation
Light		Set the Display Light Parameter
Contra		Set the Display Contrast Parameter
Invert		Set the Invert Display



### 3. Set the Format

Press **Utility** → **System** → **Format**, enter the following interface.

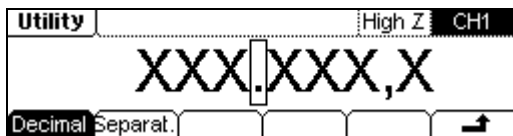

Figure 2-70  
Setting the data Format

Table 2-28 Setting the Data Format

Menu	Settings	Explanation
Decimal	•	Using dot
	,	Using comma
Separat.	No	Close the Separate.
	Space	Use Space to separate
	On	Enable the Separate

According to the different choice of the decimal and the separate, the format can have various forms:

- (1) "•" as decimal, press **Separat.** → **No**, the example is as follows:

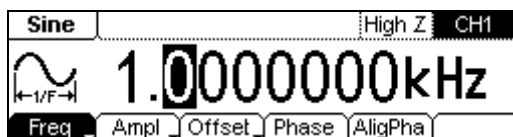

Figure 2-71 Setting the data format

- (2) "•" as decimal, press **Separat.** → **Space**, the example is as follows:

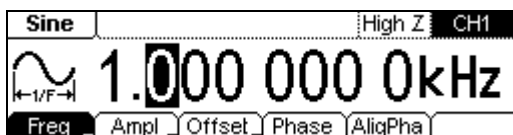

Figure 2-72 Setting the data format

(3) "." as decimal, press **Separat.** → **On**, the example is as follows:

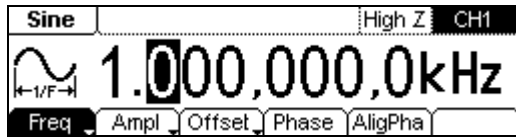

Figure 2-73 Setting the data format

(4) "," as decimal, press **Separat.** → **On**, the example is as follows:

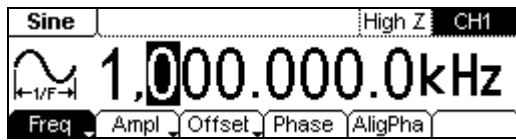

Figure 2-74 Setting the data format

(5) " " as decimal, press **Separat.** → **Space**, the example is as follows:

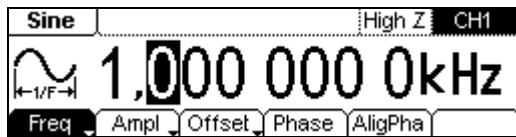

Figure 2-75 Setting the data format

(6) " " as decimal, press **Separat.** → **No**, the example is as follows:

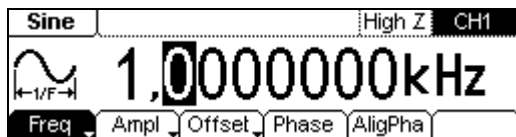

Figure 2-76 Setting the data format

#### 4. To Return to Default Setting

Press **Utility** → **→** → **Setting** → **Default** → **Yes**. Return the default setting of the system.

Table 2-29 Default Parameter Setting

Output	Default	
	CH1	CH2
Function	Sine	Ramp
Frequency	1kHz	1.5 kHz
Amplitude/Offset	5 V <sub>PP</sub> /0.000 V <sub>DC</sub>	
Unit	V <sub>PP</sub>	
Terminals	High Z	

Modulation (CH1)	Default
Carrier	1kHz Sine Wave
Modulating	100Hz Sine Wave
AM Depth	100%
FM Deviation	100Hz
FSK Hop Frequency	10Hz
Deviat.	100°
FSK Frequency	100Hz
Modulation State	Off

Sweep(CH1)	Default
Start/Stop Frequency	100Hz/1kHz
Time	1s
Mode	Linear
State	Off

Burst(CH1)	Default
Frequency	100Hz
Count	1Cycle

Period	10ms
Delay	0s
Phase	0°
State	Off

<b>Counter</b>	<b>Default</b>
Coupling	AC
Sensitivity	High
Trig Lev	71.0 (1.26V)
HFR Off	Off

<b>System</b>	<b>Default</b>
*Power-down Recall	*Disabled
Display	On
Error Array	Clear Error
Storage State and any Waveform	No change
Output State	Off

Trigger	Default
Source	Internal

Calibration	Default
State	Coded

The parameter with an asterisk (\*) is stored in the Non-Volatile Memory.

## I/O Settings

Press **Utility** → **→** → **I/O**, to view the USB parameters.

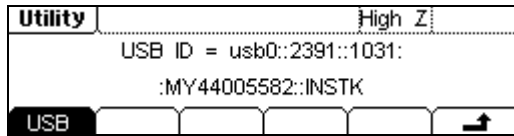

Figure 2-77  
To View the USB Parameters

## Test/Cal Settings

Press **Utility** → **➡** → **Test/Cal**, enter the following menu.



Figure 2-78 Test Menu

Table 2-30 Test Setting Menu

Menu	Settings	Explanation
Test	/	Perform System Self-Test
Info	/	Show the system information
PassWd	/	Input the password for Secure calibration
SecOn SecOff	On	Turn On Secure Setting, disables the calibration by anyone
	Off	Turn Off Secure Setting, enables the calibration by anyone
Cal	/	Enter Calibration interface

### 1. Test

Press **Utility** → **➡** → **Test/Cal** → **Test**, to perform self-testing.

- When the instrument is powered, the system will perform the self-testing automatically. This limited test can test if the instrument could work ordinarily.
- To perform a general test needs 3 seconds. If all the tests have been passed, you can use the generator freely.
- If the general test has been passed, the screen will show "Self-Test Passed"; if not, it will also tell you self-test failed and display the error message.

## 2. Info

The information includes: Model Number, Serial Number and Software Version.

## 3. Password

This function is used to prevent unauthorized or accidental calibration to the generator. When the generator is firstly shipped to the user, it is secured. You have to unlock it before calibrating the instrument.

Press **Utility** → **Test/Cal** → **PassWd**, and enter the right password. The system will display "The instrument now is UNSECURED". **SecOff** will appear, see Figure 2-79.



Figure 2-79  
Input the Calibration PassWord

## 4. Calibration

The generator has been calibrated before leaving the factory. Personal calibration is not recommended. To calibrate the generator, please contact with **RIGOL**.

## Power Amplifier Settings

PA1011 power amplifier ("PA" for short hereinafter) can be connected to and controlled by the generator for signal amplification. Before using PA, power on the instrument and then connect USB Host of the generator with USB Device of PA via an USB cable.

Press **Utility** → **→** → **PA**, enter the following menu.

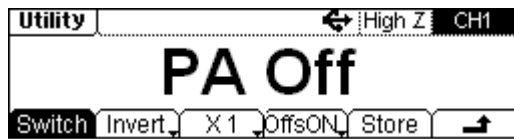

Figure 2-80  
PA Setting Interface

Table 2-31 PA Setting Menu

Menu	Settings	Explanation
Switch		Enable or Disable PA
Normal Invert		Invert the output of PA or not
X1 X10		Set the gain of PA
OffsON OffsOff		Turn on the switch to input the offset value: -12V~12V
Store		Store current work state of PA to its memory

**NOTE:** For more detail about the power amplifier, please refer to the User's Guide of PA1011.



## To Lock the Keyboard

You can lock any key or all the keys (except the power switch key) at the front panel using the keyboard lock command.

### 1. Keyboard Lock Command Introduction

```
SYSTem:KLOCK <key>,{ON|OFF|0|1} /*Lock or unlock the specified key*/
SYSTem:KLOCK? <key> /*Query if the specified key is locked*/
```

Wherein, <key> is used to specify the key and the range is as following:

MOD SWEEP BURST STORE UTILITY HELP	/*Mode/Function keys*/
SINE SQUARE RAMP PULSE NOISE ARB	/*Waveform keys*/
M1 M2 M3 M4 M5 M6	/*Menu keys*/
NUM0 NUM1 NUM2 NUM3 NUM4 NUM5	/*Keypad*/
NUM6 NUM7 NUM8 NUM9 DOT SIGN	
LEFT RIGHT KNOB	/*Direction keys and knob*/
OUTPUT1 OUTPUT2 CH	/*Output control keys and channel switch key*/
GRAPH	/*Display mode switch key*/
ALL	/*All the keys (except the power switch key) and knob at the front panel*/

{ON|OFF|0|1} is used to lock or unlock the keys. ON|1 denotes locking the specified key and OFF|0 denotes unlocking the specified key.

### 2. Two Ways to Lock or Unlock the Keyboard

#### (1) Lock or unlock the specified key by sending the command through Ultra Sigma

- Build the communication between the generator and the computer.
- Run Ultra Sigma and search for the instrument resource.
- Open the remote command control panel and send the command.

#### (2) Lock or unlock the specified key by reading the command file stored in the USB storage device

The content and format requirements of the command file are as follows.

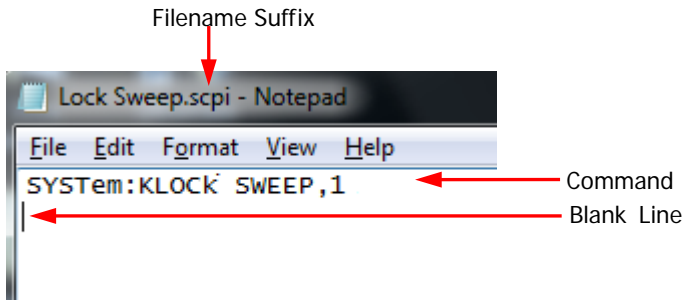

- The filename suffix must be “.scpi”.
- The file content requirements:
  - The first line: the command used to lock or unlock the specified key;
  - The second line: a blank line (cannot be omitted).

**Procedures:**

- Edit the command file according to the above requirements and store it into a USB storage device.
- Turn on the instrument and insert the USB storage device. Press **Store/Recall** to enter the store and recall interface.
- Read the command file following the steps below in the store and recall interface (refer to “**To Store and Recall**”).
  - Select “UDisk” → set the file type to “All” → select the file mentioned above → press **Recall**.

## To Use the Help System

You can get a particular help for every button on the front panel by using the built-in help system. Or you can get help about the operation of the front panel buttons with the Help List.

Press the **Help** button, enter the following interface.

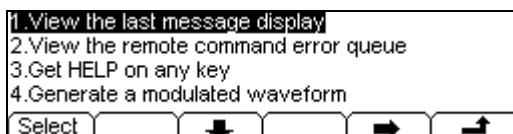

Figure 2-81 Help Menu

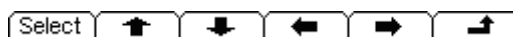

Figure 2-82 Full Menus

Table 2-32 Help Menu

Menu	Settings	Explanation
Select		Select and read the Information
↑		Page Up
↓		Page Down
→		Cursor Downward to select
←		Cursor Upward to select
↗		Exit the help menu

**1. View the last message display**

View the last message display.

**2. View the remote Command error queue**

View the remote command error queue in the remote operation.

**3. Get HELP on any key**

To get context-sensitive help on any front-panel key or menu soft key, press and hold that key for a few seconds.

**4. Generate a modulated waveform**

- (1) Configure the Carrier waveform by selecting the waveform shapes, frequency, amplitude, etc.
- (2) Configure the modulating waveform by pressing the **Mod** button.
- (3) To change the Carrier parameter, press the lighted function button (**Sine**, **Square** etc).
- (4) To turn off the modulation, press the lighted **Mod** button.

**5. Create an arbitrary waveform**

- (1) Press **Arb** → **Edit** → **Create**.
- (2) Enter the desired period, voltage limit, and the number of points and then press "Edit Pt", the first two points have defined for you.
- (3) Rotate the knob to select the desired point for editing and then use **Time** and **Voltage** to define the point. Press **Insert** to insert additional points as needed.
- (4) The waveform editor connects the last point to the voltage level of point #1 to create a continuous waveform. Make sure that the time value of the last point less than the specified period.

**6. Generate DC signal**

To output the DC signal, press **Arb** → **Load** → **BuiltIn** → **Others** → "DC" → **Select**, and you can adjust the DC offset.

**7. Reset instrument to its default state**

- (1) Press **Utility** to enter the utility function.
- (2) Choose **System** → **Setting**.
- (3) Select **Default** to reset the instrument as its default state.

**8. RIGOL Technology Support**

To obtain technical support, contract with local **RIGOL** Support Center or go to the website: [www.rigolna.com](http://www.rigolna.com).

## Chapter 3 Examples

To help users grasping how to use DG1000 series Dual-Channel Generator more efficiently, here we will give some examples in details.

This chapter covers the following examples:

- Output from Single Channel
  - Example 1: Output a Sine Wave*
  - Example 2: Output a Square Wave*
  - Example 3: Output a Ramp Wave*
  - Example 4: Output a Pulse Wave*
  - Example 5: Output a Noise Wave*
  - Example 6: Output a Stored Arbitrary Waveform*
  - Example 7: Create an Arbitrary Waveform*
  - Example 8: To Generate a AM Waveform*
  - Example 9: To Generate a FSK Waveform*
  - Example 10: To Generate a Linear Sweep Waveform*
  - Example 11: To Generate a Burst Waveform*
- Output from Double Channels
- Example for Channel Coupling
- Example for Channel Copy
- To Measure with the Counter

## Output from Single Channel

### Example 1: Output a Sine Waveform

How to generate a Sine Waveform with 20 kHz frequency, 2.5 V<sub>PP</sub> Amplitude, 0 V<sub>DC</sub> Offset and 45° phase.

#### The operation steps:

1. Set the Frequency.

- (1) Press **Sine** → **Freq/Period** → **Freq** which will display in reverse color.
- (2) Enter "20" from the keypad and choose the unit "kHz". The Frequency is set to be 20 kHz.

2. Set the Amplitude.

- (1) Press **Ampl/HiLev** → **Ampl** which will display in reverse color.
- (2) Enter "2.5" from the keypad and choose the unit "V<sub>PP</sub>". The Amplitude is set to be 2.5V<sub>PP</sub>.

3. Set the Offset.

- (1) Press **Offset/LoLev** → **Offset** which will display in reverse color.
- (2) Enter "0" from the keypad and choose the unit "V<sub>DC</sub>", The Offset is set to be 0 V<sub>DC</sub>.

4. Set the Initial Phase.

- (1) Press **Phase** which will display in reverse color.
- (2) Enter "45" from the keypad and choose the unit "°". The phase is set to be 45°.

After finishing the above settings, press **View**, the output of the Generator is shown as in the following figure.

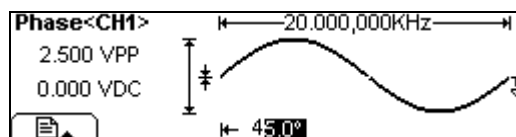

Figure 3-1  
Sine Waveform Output

## Example 2: Output a Square Waveform

How to generate a Square waveform with 1MHz Frequency, 2 VRMS Amplitude, 10m VDC Offset, 30% Duty Cycle and 30° phase.

### The operation steps:

#### 1. Set the Frequency.

- (1) Press **Square** → **Freq/Period** → **Freq** which will display in reverse color.
- (2) Enter "1" from the keypad and choose the unit "MHz" to set the Frequency as 1MHz.

#### 2. Set the Amplitude.

- (1) Press **Ampl/HiLev** → **Ampl** which will display in reverse color.
- (2) Enter "2" from the keypad and choose the unit "VRMS" to set the Amplitude as 2 VRMS.

#### 3. Set the Offset.

- (1) Press **Offset/LoLev** → **Offset** which will display in reverse color.
- (2) Enter "10" from the keypad and choose the unit "mVDC" to set the Offset as 10m VDC.

#### 4. Set the Duty Cycle.

- (1) Press **DtyCyc** which will display in reverse color.
- (2) Enter "30" from the keypad and choose the unit "%" to set the Duty Cycle as 30%.

#### 5. Set the Initial Phase.

- (1) Press **Phase** which will display in reverse color.
- (2) Enter "30" from the keypad and choose the unit "°" to set the Phase as 30°.

After finishing the above settings, press **View**, the generated waveform is shown in Figure 3-2.

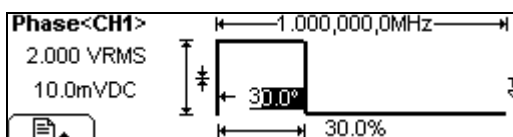

Figure 3-2  
Square Waveform Output

## Example 3: Output a Ramp Waveform

How to generate a Ramp waveform with 10ms Period, 100mV<sub>PP</sub> Amplitude, 20mV<sub>DC</sub> Offset, 80% Symmetry and 60° Phase.

### The operation steps:

1. Set the Period.

- (1) Press **Ramp** → **Freq/Period** → **Period** which will display in reverse color.
- (2) Input "10" from the keypad and choose the unit "ms" to set the Period as 10ms.

2. Set the Amplitude.

- (1) Press **Ampl/ HiLev** → **Ampl** which will display in reverse color.
- (2) Enter "100" from the keypad and choose the unit "mV<sub>PP</sub>" to set the Amplitude as 100mV<sub>PP</sub>.

3. Set the Offset.

- (1) Press **Offset /LoLev** → **Offset** which will display in reverse color.
- (2) Enter "20" from the keypad and choose the unit "mV<sub>DC</sub>" to set the Offset as 20mV<sub>DC</sub>.

4. Set the Symmetry.

- (1) Press **Symm** which will display in reverse color.
- (2) Enter "80" from the keypad and choose the unit "%" to set the Symmetry as 80%.

5. Set the Phase.

- (1) Press **Phase** which will display in reverse color.
- (2) Enter "60" from the keypad and choose the unit "°" to set the Phase as 60°.

After finishing the above settings, press **View**, the generated waveform is shown in Figure 3-3.

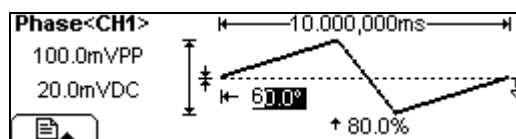

Figure 3-3  
Ramp Waveform Output



## Example 4: Output a Pulse Waveform

How to generate a Pulse waveform with 5kHz Frequency, 50mV<sub>PP</sub> Amplitude, 5mV<sub>DC</sub> Offset, 20μs Pulse Width (Duty Cycle is 10%) and 200μs Delay.

### The operation steps:

1. Set the Frequency.

- (1) Press **Pulse** → **Freq/Period** → **Freq** which will display in reverse color.
- (2) Input "5" from the keypad and choose "kHz" to set the Frequency as 5 kHz.

2. Set the Amplitude.

- (1) Press **Ampl/ HiLev** → **Ampl** which will display in reverse color.
- (2) Enter "50" from the keypad and choose the unit "mV<sub>PP</sub>" to set the Amplitude as 50mV<sub>PP</sub>.

3. Set the Offset.

- (1) Press **Offset /LoLev** → **Offset** which will display in reverse color.
- (2) Enter "5" from the keypad and choose the unit "mV<sub>DC</sub>" to set the Offset as 5mV<sub>DC</sub>.

4. Set the Pulse Width.

- (1) Press **DtyCyc/Width** → **Width** which will display in reverse color.
- (2) Enter "20" from the keypad and choose the unit "μs" to set the Pulse Width as 20μs.

5. Set the Delay.

- (1) Press **Del** which will display in reverse color.
- (2) Enter "200" from the keypad and choose the unit "μs" to set the Delay as 200μs.

After finishing the above settings, press **View**, the generated waveform is shown in Figure 3-4.

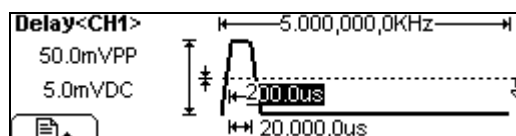

Figure 3-4  
Pulse Waveform Output

## Example 5: Output a Noise Waveform

How to generate a Noise waveform with 30mV<sub>PP</sub> Amplitude and 10mV<sub>DC</sub> Offset.

### The operation steps:

1. Set the Amplitude.

(1) Press **Ampl/ HiLev** → **Ampl** which will display in reverse color.

(2) Enter "30" from the keypad and choose the unit "mv<sub>pp</sub>" to set the Amplitude as 30mV<sub>PP</sub>.

2. Set the Offset.

(1) Press **Offset/ LoLev** → **Offset** which will display in reverse color.

(2) Enter "10" from the keypad and choose the unit "mV<sub>DC</sub>" to set the Offset as 10mV<sub>DC</sub>.

After finishing the above settings, press **View**, the generated waveform is shown in Figure 3-5.

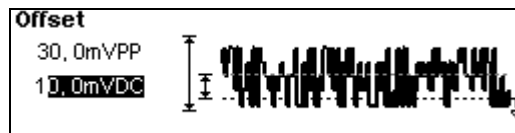

Figure 3-5  
Noise Waveform Output

## Example 6: Output a Stored Arbitrary Waveform

How to generate an arbitrary waveform (ExpRise) with 2MHz Frequency, 5V<sub>RMS</sub> Amplitude, 10 mV<sub>DC</sub> Offset and 60° Phase.

### The operation steps:

1. Set the Type of the Arbitrary Waveform.
  - (1) Press **Arb** → **Load**, to choose the built-in waveform.
  - (2) Press **BuiltIn** → **Maths**, use the knob to choose “ExpRise” and press **Select** to return the Main Menu of **Arb**.
  
2. Set the Frequency.
  - (1) Press **Pulse** → **Freq/Period** → **Freq** which will display in reverse color.
  - (2) Input “2” from the keypad and choose the unit “MHz” to set the Frequency as 2MHz.
  
3. Set the Amplitude.
  - (1) Press **Ampl/ HiLev** → **Ampl** which will display in reverse color.
  - (2) Enter “5” from the keypad and choose the unit “V<sub>RMS</sub>” to set the Amplitude as 5 V<sub>RMS</sub>.
  
4. Set the Offset.
  - (1) Press **Offset /LoLev** → **Offset** which will display in reverse color.
  - (2) Enter “10” from the keypad and choose the unit “mV<sub>DC</sub>” to set the Offset as 10 mV<sub>DC</sub>.
  
5. Set the Phase.
  - (1) Press **Phase** which will display in reverse color.
  - (2) Enter “60” from the keypad and choose the unit “°” to set the Phase as 60°.

After finishing the above settings, press **View**, the generated waveform is shown in Figure 3-6.

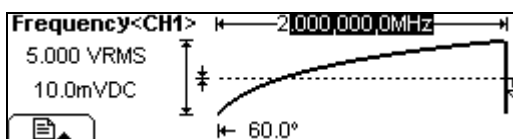

Figure 3-6 Arbitrary Waveform Output

## Example 7: Create an Arbitrary Waveform

How to generate an arbitrary Ramp Waveform as the figure shows below.

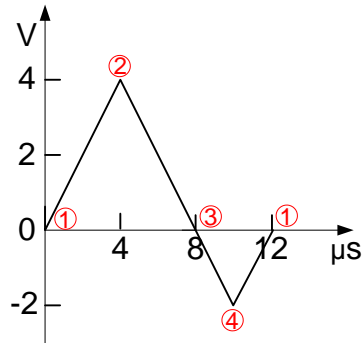

Figure 3-7  
Arbitrary Waveform Output

### The operation steps:

1. Create a new Waveform:  
Press **Arb** → **Edit** → **Create**, to activate the waveform editing function. The waveform is defined by setting the time and voltage of the points.
2. Set the period.
  - (1) Press **Period** which will display in reverse color.
  - (2) Input "12" from the keypad and choose the unit "μs" to set the Period as 12μs.
3. Set the Voltage Limit.
  - (1) Press **LevelHi**, and enter "4" from the keypad, choose the unit "V", to set the High Level as 4V.
  - (2) Press **LevelLo**, and enter "-2" from the keypad, choose the unit "V", to set the low Level as -2V.
4. Choose the Interpolation Method.  
Press **Interp.** → **Interpolation On**, to perform linear connection between the points.
5. Set the Number of the initializing Points.  
Set the Initializing Point Number as "4".

6. Edit the Waveform Points.
  - (1) Edit the Voltage and Time of the points to define a waveform. Insert or delete the point If needed.
  - (2) Press **Points**, use the knob or the keypad to shift the point number. The voltage and time of the points are defined below in Table 3-1.

Table 3-1 The Setting of Time and Voltage of the points

Point	Time	Voltage
1	0s	0V
2	4 $\mu$ s	4V
3	8 $\mu$ s	0V
4	10 $\mu$ s	-2V

7. To save the Waveform.
  - (1) Press **Save** to store the waveform in one of the 10 Non-Volatile Memories: ARB1~ARB10.
  - (2) Press **Store**, input the filename and press **Store**.
  - (3) Press **Recall** to read the stored waveform to the Volatile Memory. Only one self-built waveform can be stored. If a new one is stored, the old one will be erased.

After finishing the above settings, press **View**, the generated waveform is shown in Figure 3-8.

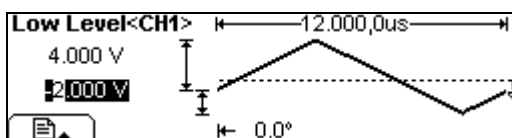

Figure 3-8  
The Self-Defined Ramp Waveform

**NOTE:** The system will connect the voltage level of the last point to the first point, thus to generated a continuous waveform.

## Example 8: To Generate a AM Waveform

How to generate an AM Waveform with depth of 70%, The Carrier is a Sine Wave with 2.5 kHz Frequency, and the modulating Wave is a Sine Wave with 150 Hz Frequency.

### The operation steps:

1. Choose the Carrier Function:  
Press **Sine**, and choose the Sine Waveform as the Carrier Wave.  
The default setting of the Source is internal.
2. Set the Frequency of the Carrier.  
Press **Period/Freq** → **Freq** which will display in reverse color. Input "2.5" from the keypad and choose the unit "kHz" to set the Frequency as 2.5kHz.  
  
For the other parameters, use the default values, you can view all the parameters in the Graph mode.
3. Set the Modulation Type AM.  
Press **Mod** → **Type** → **AM** → **↕**, Please notice that the state message shown on the top left side of the screen is "AM".
4. Set the Modulation Depth.  
Press **Depth**, use the keypad to enter "70", choose the unit "%", setting the Modulation Depth as 70%.
5. Set the AM Frequency.  
Press **AMFreq**, use the keypad to enter "150", choose the unit "Hz", setting the AM Frequency as 150Hz.
6. Choose the Modulating Waveform.  
Press **Shape** → **Sine** → **↕**, to choose Sine Waveform as the Modulating Waveform.  
Please note that the State Message on the top left side of the screen shows "Sine".

After finishing the above settings, press **View**, the generated AM Waveform is shown in Figure 3-9.

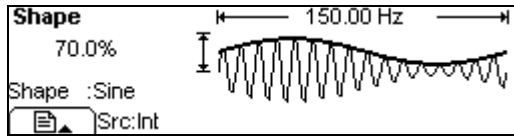

Figure 3-9  
The AM Output

## Example 9: To Generate a FSK Waveform

How to generate a FSK Waveform with 800Hz Hop Frequency and 200Hz FSK Rate. The Carrier is a Sine Wave with 10 kHz Frequency.

### The operation steps:

1. Choose the Carrier Function.  
Press **Sine**, and choose the Sine Waveform as the Carrier Function.  
The default setting of the Source is Internal.
2. Set the Frequency of the Carrier.  
Press **Period/Freq** → **Freq** which will display in reverse color. Input "10" from the keypad and choose the unit "kHz" to set the Frequency as 10 kHz.  
  
For the other parameters, use the default values, you can view all the parameters in the Graph mode.
3. Set the Modulation Type FSK.  
Press **Mod** → **Type** → **FSK**, choose FSK. Please notice that the message shown on the top left side of the screen is "FSK".
4. Set the Hop Frequency.  
Press **HopFreq**, use the keypad to enter "800", choose the unit "Hz", setting the Hop Frequency as 800Hz.
5. Set the FSK Rate.  
Press **FSKRate**, use the keypad to enter "200", choose the unit "Hz", setting the FSK Rate as 200Hz.

After finishing the above settings, press **View**, the generated FSK Waveform is shown in Figure 3-10.

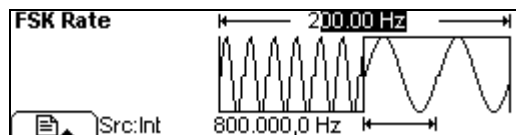

Figure 3-10  
The FSK Output



## Example 10: To Generate a Linear Sweep Waveform

How to generate a Sine Sweep Waveform whose frequency starts from 100Hz to 10kHz. Use the Internal Trigger Mode, Linear Sweep, and the Sweep Time is 1s.

### The operation steps:

1. Choose the Sweep Function.  
Press **Sine**, and choose the Sine Waveform as the Sweep Function.  
The default setting of the Source is Internal.
2. Set the Parameters of the Sweep Function.  
Use the default values. You can view all the parameters in the Graph mode.
3. Set the Sweep Mode.  
Press **Sweep** → **Linear/Log** and choose Linear.
4. Set the Sweep Time.  
Press **Time**, use the keypad to enter "1", choose the unit "s", to set the Sweep Time as 1s.
5. Set the Start Frequency.  
Press **Start**, use the keypad to enter "100", choose the unit "Hz", to set the Start Frequency as 100Hz.
6. Set the Stop Frequency.  
Press **Stop**, use the keypad to enter "10", choose the unit "kHz", to set the Stop Frequency as 10 kHz.

After finishing the above settings, the instrument generates the specified Sweep waveform whose frequency starts from 100Hz and stops at 10 kHz. Press **View**, the Waveform is shown in Figure 3-11.

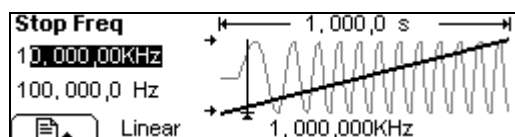

Figure 3-11  
The Sweep Waveform Output

**Instructions**

If necessary, you can set the frequency Limits by setting the Center Frequency and the frequency range. These parameters are similar to the Start and Stop frequency, which will provide more flexibility for you. To generate the same waveform, set the Center Frequency to be 5.050 kHz, the frequency range is 9.900 kHz.

## Example 11: To Generate a Burst Waveform

How to generate a Burst Waveform that has 3 Cycles, 0° Phase, 200 $\mu$ s delay and the period is 10ms.

### The operation steps:

1. Choose the Burst Function.  
Press **Square**, and choose the Square Waveform as the Burst Function.  
The default setting of the Source is Internal.
2. Set the Parameters of the Burst Function.  
Use the default values. You can view all the parameters in the Graph mode.
3. Set the Burst Mode.  
Press **Burst** → **NCycle** choose N-Cycle Mode.
4. Set the Burst Period.  
Press **Period**, use the keypad to enter "10", choose the unit "ms" and set the Period as 10 ms.
5. Set the Start Phase.  
Press **Phase**, use the keypad to enter "0", choose the unit "°", setting the Start phase as 0°.
6. Set the Burst Cycles.  
Press **Cycles**, use the keypad to enter "3", choose the unit "Cyc", setting the Burst Cycle as 3.
7. Set the Delay.  
Press **Delay**, use the keypad to enter "200", choose the unit " $\mu$ s", setting the Burst Delay as 200 $\mu$ s.

After finishing the above settings, the instrument generates the specified 3-Cycle Burst waveform with a period of 10ms. Press **View**, the generated waveform is shown in Figure 3-12.

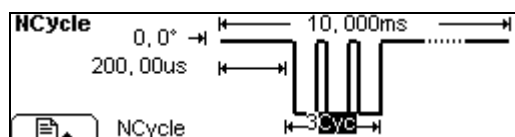

Figure 3-12  
The Burst Waveform Output

## Output from Double Channels

Output the same Sine wave from both CH1 and CH2, connect the Generator to **RIGOL**'s Oscilloscope and view the waveform output.

### The operation steps:

1. Use the BNC cable listed in Appendix A to connect the two [Output] connectors to the Oscilloscope, and then press the **Output** buttons
2. As introduced in "**Example 1: Output a Sine Wave**", set the output parameters of the two channels as shown in the following figure.

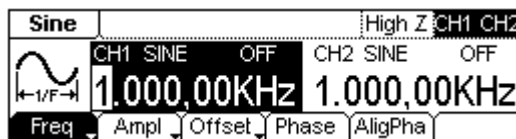

Figure 3-13

Set the same Sine Wave

3. Press **Aligpha** in the above figure, adjust the Oscilloscope, using the Y-T and X-Y (Lissajous Figure) modes to view the waveform output. See Figure 3-14 and Figure 3-15.

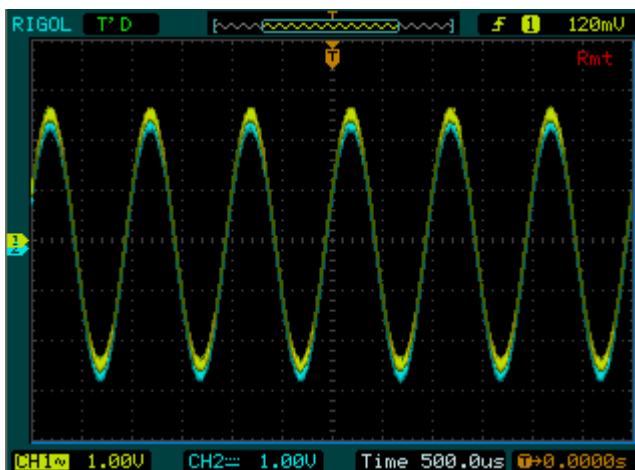

Figure 3-14

Output the Same Signal

**Analysis:** No phase deviation, waveforms overlapping.

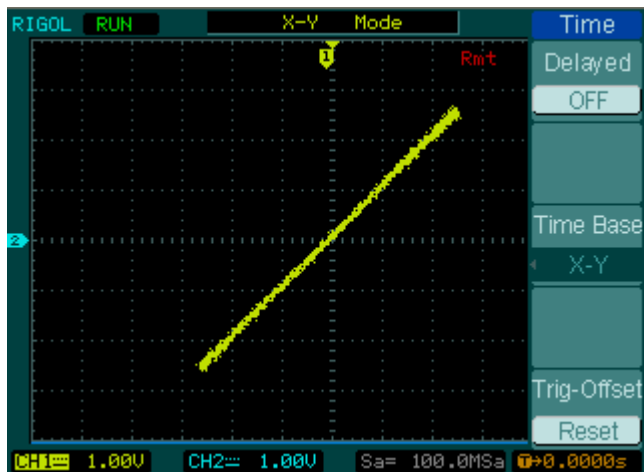

Figure 3-15  
Output the Same Signal (Lissajous Figure)

**Analysis:** No phase deviation, Lissajous Figure display as a straight line.

Now press **Utility** → **Coupling** → **Switch** → “Coupling On” → **PhaDev**, use the keypad to input “90” and choose the unit of “°”. Press **Alpha** again in Figure 3-13, view the waveform output in the Oscilloscope.

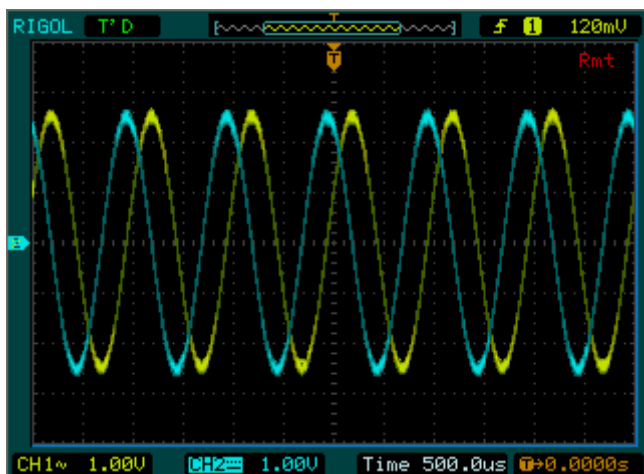

Figure 3-16  
Output Signals with 90° Phase Deviation

**Analysis:** 90° phase deviation, waveforms do not overlap.

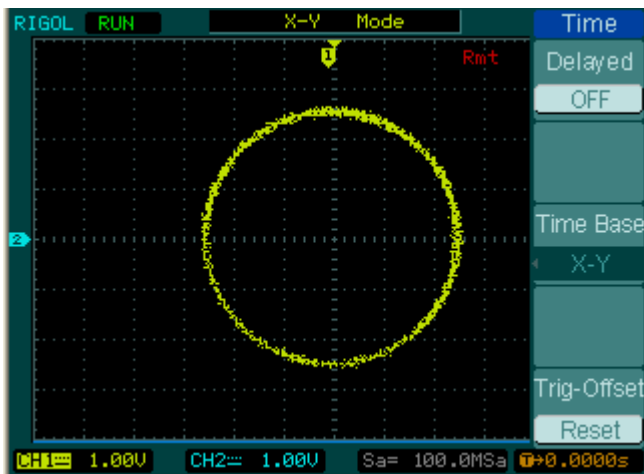

Figure 3-17  
Output Signals with 90° Phase Deviation (Lissajous Figure)

**Analysis:** 90° phase deviation, Lissajous Figure display as a circle.

## Example for Channel Coupling

Choose CH1 as the base channel, set the phase deviation to be  $10^\circ$ , view the waveforms before and after the coupling.

### The operation steps:

1. Set the parameters of CH1 as shown in the following figure: Sine wave, frequency 1 kHz, amplitude  $5V_{PP}$ , Offset  $0 V_{DC}$ , phase  $0^\circ$ .

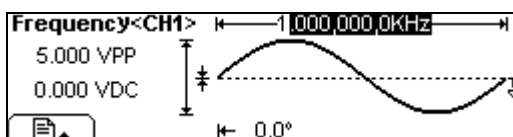

Figure 3-18

Parameters Setting in CH1

2. Set the parameters of CH2 as shown in the following figure: Ramp wave, frequency 1.5 kHz, amplitude  $5V_{PP}$ , Offset  $0 V_{DC}$ , phase  $0^\circ$ .

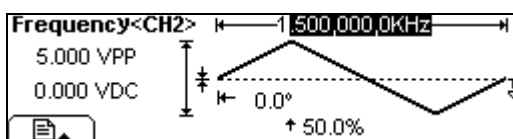

Figure 3-19

Parameters Setting in CH2

3. Press **Utility** → **Coupling** → **Switch** → "Coupling On". Open the coupling function.
4. Press **BaseCH** → "Channel\_1". Choose CH1 as the base channel.
5. Press **PhaDev**, use the keypad to input "10" and choose the unit of " $^\circ$ ". Set the phase deviation to be  $10^\circ$ .
6. Press **↵** to save the exit the coupling setting. Press **View**, in the Graph Mode, you will see the phase of CH2 has been changed to  $10^\circ$ .

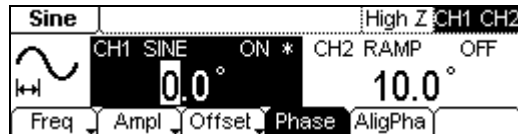

Figure 3-20  
Channel Coupling Interface

- As shown in the above figure, in the display area of the base channel CH1, there is a "\*" sign under the Phase menu, which indicates that the phase of CH2 will change according to CH1.
- As shown in the following figure, use the knob to change the phase of CH1, then the phase of CH2 will automatically change. The phase deviation is always 10°.

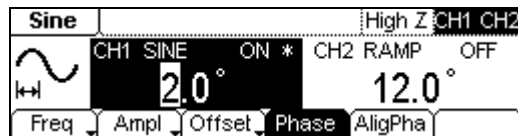

Figure 3-21  
Phase Coupling Instruction

- Setting of the frequency coupling is similar to phase coupling.



## Example for Channel Copy

Copy the parameters from CH1 to CH2.

### The operation steps:

1. Set the parameters of CH1 as shown in the following figure: Sine wave, frequency 1kHz, amplitude 5V<sub>PP</sub>, Offset 0 V<sub>DC</sub>, phase 10°.

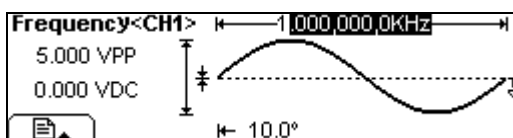

Figure 3-22  
Parameters Setting in CH1

2. Set the parameters of CH2 as shown in the following figure: Ramp wave, frequency 1.5 kHz, amplitude 5V<sub>PP</sub>, Offset 0 V<sub>DC</sub>, phase 0°.

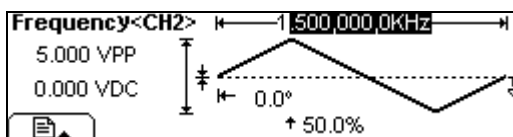

Figure 3-23  
Parameters Setting in CH2

3. Press **Utility** → **Coupling** → **Switch** → "Coupling Off" → **CopyCH** → 1 → 2 → **Confirm** → **↵**. Parameters in CH1 will be copied to CH2 as shown in the following.

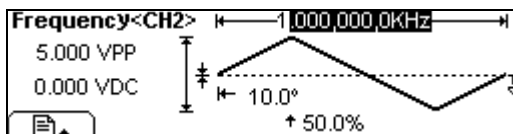

Figure 3-24  
Parameters in CH2 after the copying

**NOTE:** Channel copy is limited by parameters inspection. See the explanation in section "Channel Copy" in page 2-56.

## To Measure with the Counter

Use the Counter to measure the signal outputted from CH1.

### The operation steps:

1. Press **Utility** → **Count**, enter the measurement mode of the counter. At the same time, the output of CH2 will turn off automatically.
2. Use the BNC cable listed in Appendix A to connect the [Output] connector of CH1 to the input terminal of the Counter, press the **Output** button of CH1.
3. To set the measurement
  - (1) Auto measure mode  
Press **Auto**, in this mode, the coupling mode is "AC", the counter automatically adjusts the trig level and sensitivity until the display is steady.
  - (2) Manually measure mode
    - To set the coupling mode  
Press **Setup** → **AC/DC** → **AC** to set the coupling mode to be "AC".
    - To set the sensitivity  
Press **Setup** → **Sens** → **Medium**.
    - To set the trigger level  
Press **Setup** → **TrigLev**, use the direction key and the knob to adjust the trig level to be "62.0", that is 0.72V.
    - To set the high frequency restrain On/Off  
Press **Setup** → **HFRon/Off**, choose "HFROff".

After all the set was done, the counter will measure the signal according to the current set. If the reading is unsteady, please repeat the above step until it is steady.

4. To view the result
  - (1) In default state, the measure result is frequency value, see the following figure.

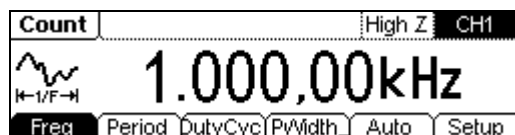

Figure 3-25 Frequency View

- (2) Press **Period**, the period will display as shown in the following figure.

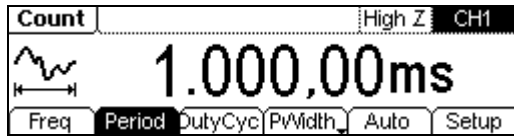

Figure 3-26 Period View

- (3) Press **DutyCyc**, the Duty cycle will display as shown in the following figure.



Figure 3-27 Duty Cycle View

- (4) Press **PWidth**, the positive width will display as shown in the following figure.



Figure 3-28 Positive Width View

- (5) Press **NWidth**, the negative width will display as shown in the following figure.



Figure 3-29 Negative Width View



---

## Chapter 4 Prompt Messages & Troubleshooting

This chapter covers the following topics:

- Prompting Messages
  - Common Messages*
  - Error Messages*
  - Data Overflow*
- Troubleshooting

# Prompting Messages

## Common Messages

1. **Need Help? Press and hold down any key. Settings are restored from last power-down. Selected interface is USB.**

When the instrument is powered, this message will appear to inform users that all the settings have been restored and you can operate the instrument normally. The instrument detected current I/O is USB, and informs the user that no new USB device is detected.

2. **No changes.**

When the waveform parameter is being altered, if the user cancels the operation, the message will prompt.

3. **Selected Arb is \*\*\*.**

Press **Arb**, this message will appear to inform users that the default selection of arbitrary waveform type is "\*\*\*".

4. **First, set the all over waveform parameters.**

To inform the user, set the general waveform parameter first. Then set the parameters for each point.

5. **Editing the existing waveform parameters.**

Perform the waveform edit operation, and inform the user that operation can be taken to edit the current waveform parameter.

6. **Trigger ignored-OUTPUT is off.**

When the OUTPUT is disabled, the Trigger Output will be disabled automatically.

7. **Instrument is triggered.**

Press **Sweep** / **Burst** → **Trigger** → **Source** → **Manual**, this message will appear to inform users that the instrument has performed a trigger.

8. **Press any F key to redisplay menu when it disappears.**

When menu disappeared, press any menu key will recall it.

9. **Burst period increased to fit entire burst.**

The PRI of Period is higher than that of the Burst Period. As long as the burst period does not reach its maximum, the generator will increase the burst period to cater to the need of the specific burst cycle or waveform frequency.

## Error Messages

**1. Sorry, unable to N-Cycle burst with noise.**

Noise cannot be used in the N-Cycle mode; it can only be used in the gated burst.

**2. Please select a valid file.**

If the selected place is empty when recall or delete a file, this message will appear.

**3. No Arbitrary waveform in buffer.**

If not arbitrary waveform has edited, press **Store/Recall** → **Type** → "Data" → **Store**, this message will appear.

**4. Sorry, Channel2 does not support.**

If current selected channel is CH2, when press **Mod** / **Sweep** / **Burst**, this message will appear to inform users that Channel2 does not support modulation, sweep and burst functions.



## Data Overflow

### 1. Frequency upper limit=\*\*\*

Different waveforms have different frequency upper limits:

DG1022	DG1022A
Sine wave frequency upper limit =20MHz	Sine wave frequency upper limit =25MHz
Square wave frequency upper limit =5MHz	Square wave frequency upper limit =5MHz
Ramp wave frequency upper limit =150kHz	Ramp wave frequency upper limit =500kHz
Pulse wave frequency upper limit =3MHz	Pulse wave frequency upper limit =5MHz
Arbitrary wave frequency upper limit =5MHz	Arbitrary wave frequency upper limit =5MHz

If the set frequency is higher than the upper limit, the system will adjust the frequency to the corresponding upper limit.

### 2. Frequency lower limit=\*\*\*

Different waveforms have different frequency lower limits (the frequency lower limits of DG1022 and DG1022A are the same):

Sine wave frequency lower limit=1 $\mu$ Hz

Square wave frequency lower limit=1 $\mu$ Hz

Ramp wave frequency lower limit=1 $\mu$ Hz

Pulse wave frequency lower limit=500 $\mu$ Hz

Arbitrary wave frequency lower limit=1 $\mu$ Hz

If the set frequency is lower than the lower limit, the system will adjust the frequency to the corresponding lower limit.

### 3. Period upper limit=\*\*\*

Different waveforms have different period upper limits (the period upper limits of DG1022 and DG1022A are the same):

Sine wave period upper limit=1Ms

Square wave period upper limit=1Ms

Ramp wave period upper limit=1Ms

Pulse wave period upper limit= 2ks

Arbitrary wave period upper limit 1Ms

If the set period is higher than the upper limit, the system will adjust the period to the corresponding upper limit.

**4. Period lower limit=\*\*\***

Different waveforms have different period lower limits:

<b>DG1022</b>	<b>DG1022A</b>
Sine wave period lower limit = 50ns	Sine wave period lower limit = 40ns
Square wave period lower limit =200ns	Square wave period lower limit =200ns
Ramp wave period lower limit =6.6667μs	Ramp wave period lower limit =2μs
Pulse wave period lower limit = 333.3ns	Pulse wave period lower limit = 200ns
Arbitrary wave period lower limit =200ns	Arbitrary wave period lower limit =200ns

If the set period is lower than the lower limit, the system will adjust the period to the corresponding lower limit.

**5. Amplitude(Vpp)upper limit=\*\*\*VPP**

Different modes have different amplitude upper limits; amplitude upper limit may vary in the same mode if the load settings are different.

**6. Amplitude(Vrms)upper limit=\*\*\*VRMS**

Different modes have different amplitude upper limits; amplitude upper limit may vary in the same mode if the load settings are different.

**7. Amplitude(Vpp)Lower limit=\*\*\*VPP**

Different modes have different amplitude lower limit; amplitude lower limit may vary in the same mode if the load settings are different.

**8. Amplitude(Vrms)Lower limit=\*\*\*VRMS**

Different modes have different amplitude lower limit; amplitude lower limit may vary in the same mode if the load settings are different.

**9. High Level upper limit\*\*\*V**

Different modes have different High Level upper limit; High Level upper limit may vary in the same mode if the load settings are different.

**10. Low Level lower negative limit=\*\*\*V**

Different modes have different Low Level lower limit; Low Level lower limit may vary in the same mode if the load settings are different.

**11. Offset upper limit=\*\*\*V**

Different modes have different Offset upper limit; Offset upper limit may vary in

---

the same mode if the load settings are different.

**12. Offset lower negative limit=\*\*\*V**

Different modes have different Offset lower limit; Offset lower limit may vary in the same mode if the load settings are different.

**13. Duty Cycle upper limit=\*\*\*%**

In Square mode, different frequency range corresponds to different Duty Cycle limit.

For a frequency lower than 3 MHz (include), the range is from 20% to 80%;

For a frequency between 3~4 MHz (include), the range is from 40% to 60%;

For a frequency between 4~5 MHz, the Duty Cycle is set to be 50%.

**14. Duty Cycle lower limit=\*\*\*%**

In Square mode, different frequency range corresponds to different Duty Cycle limit.

For a frequency lower than 3 MHz (include), the range is from 20% to 80%;

For a frequency between 3~4 MHz (include), the range is from 40% to 60%;

For a frequency between 4~5 MHz, the Duty Cycle is set to be 50%.

**15. Symmetry upper limit=100%**

In Ramp mode, the Symmetry upper limit is 100%. If the specified symmetry is greater than 100%, the system will adjust the symmetry to 100% automatically.

**16. Symmetry lower limit=0%**

In the Ramp mode, the Symmetry lower limit is 0.0%. If the specified symmetry is less than 0.0%, the system will adjust the symmetry to 0.0% automatically.

**17. Duty Cycle is set to the Max of current pulse.**

When setting of duty cycle of Pulse exceeds upper limit, the message will appear and the system will adjust the value to the Max automatically.

**18. Duty Cycle is set to the Min of current pulse.**

When setting of duty cycle of Pulse is lower than the lower limit, the message will appear and the system will adjust the value to the Min automatically.

**19. Initial#of point upper limit=4k**

The number of initial points upper limit is 4,096. If the specified waveform has more than 4,096 points, the system will adjust the point number to 4,096 automatically.

**20. Initial#of point lower limit=2**

The default initial point number is 2, the lower limit of the initial points. If the

specified initial point is less than 2, the system will adjust the number to 2 automatically.

**21. Currently on the last defined point.**

When the user is about to edit the last defined point, this message will prompt.

**22. Voltage upper limit=\*\*\***

The message will appear when the set voltage value of the point during edit arbitrary waveform is higher than the high level set before.

**23. Voltage lower limit=\*\*\***

The message will appear when the set voltage value of the point during edit arbitrary waveform is lower than the low level set before.

**24. Time upper limit=\*\*\***

The message will appear when the set time of the point during edit arbitrary waveform is higher than the period set before.

**25. Time lower limit=\*\*\***

The message will appear when the set time of the point during edit arbitrary waveform is lower than the period set before.

**26. AM Depth upper limit=120.0%**

The AM Depth upper limit is 120.0%. If the specified AM Depth is greater than 120.0%, the system will adjust the AM Depth to 120.0% automatically.

**27. AM Depth lower limit=0.0%**

The AM Depth lower limit is 0.0%. If the specified AM Depth is less than 0.0%, the system will adjust the AM Depth to 0.0% automatically.

**28. AM Frequency upper limit=20kHz**

The AM Frequency upper limit is 20 kHz. If the specified value is higher than 20kHz, the system will adjust the AM Frequency to 20kHz automatically.

**29. AM Frequency lower limit=2mHz**

The AM Frequency lower limit is 2mHz. If the specified value is lower than 2mHz, the system will adjust the AM Frequency to 2mHz automatically.

**30. Deviation cannot exceed Carrier Frequency.**

In external FM, the carrier Frequency should always be higher than or equal to the deviation frequency.

**31. Frequency Deviation lower limit=1μHz**

In external FM, frequency deviation lower limit is 1μHz. If the specified value is lower than 1μHz, the system will adjust the Frequency deviation to 1μHz.

---

automatically.

**32. Deviation cannot exceed Carrier Frequency**

In internal FM, the carrier Frequency should always be higher than or equal to the deviation frequency.

**33. Frequency Deviation lower limit=1 $\mu$ Hz**

In internal FM, frequency deviation lower limit is 1 $\mu$ Hz. If the specified value is lower than 1 $\mu$ Hz, the system will adjust the Frequency deviation to 1 $\mu$ Hz automatically.

**34. FM Frequency upper limit=20kHz**

In internal FM, the FM frequency upper limit is 20 kHz. If the specified value is higher than 20kHz, the system will adjust the FM Frequency to 20kHz automatically.

**35. FM Frequency lower limit=2mHz**

In internal FM, the FM frequency lower limit is 2mHz. If the specified value is lower than 2mHz, the system will adjust the FM Frequency to 2mHz automatically.

**36. Hop Frequency upper limit=\*\*\***

The message will appear when the set Hop Frequency is higher than the upper limit in external FSK.

**37. Hop Frequency lower limit=1 $\mu$ Hz**

In external FSK, Hop Frequency lower limit is 1 $\mu$ Hz. If the specified value is lower than 1 $\mu$ Hz, the system will adjust the Hop Frequency to 1 $\mu$ Hz automatically.

**38. Hop Frequency upper limit=\*\*\***

The message will appear when the set Hop Frequency is higher than the upper limit in internal FSK.

**39. Hop Frequency lower limit=1 $\mu$ Hz**

In internal FSK, Hop Frequency lower limit is 1 $\mu$ Hz. If the specified value is lower than 1 $\mu$ Hz, the system will adjust the Hop Frequency to 1 $\mu$ Hz automatically.

**40. FSK Rate upper limit=50kHz**

In internal FSK, the FSK Rate upper limit is 50 kHz. If the specified FSK Rate is greater than 50kHz, the system will adjust the FSK Rate to 50kHz automatically.

**41. FSK Rate lower limit=1 $\mu$ Hz**

In internal FSK, the FSK Rate lower limit is 1 $\mu$ Hz. If the specified FSK Rate is less than 1 $\mu$ Hz, the system will adjust the FSK Rate to 1 $\mu$ Hz automatically.

**42. Phase Deviation upper limit=360.0°**

In external PM, the Phase deviation upper limit is  $360^{\circ}$ . If the specified Phase deviation is greater than  $360^{\circ}$ , the system will adjust the Phase deviation to  $360^{\circ}$  automatically.

**43. Phase Deviation lower limit=0.0°**

In external PM, the Phase deviation lower limit is  $0^{\circ}$ . If the specified Phase deviation is less than  $0^{\circ}$ , the system will adjust the Phase deviation to  $0^{\circ}$  automatically.

**44. Phase Deviation upper limit=360.0°**

In internal PM, the Phase deviation upper limit is  $360^{\circ}$ . If the specified Phase deviation is greater than  $360^{\circ}$ , the system will adjust the Phase deviation to  $360^{\circ}$  automatically.

**45. Phase Deviation lower limit=0.0°**

In internal PM, the Phase deviation lower limit is  $0^{\circ}$ . If the specified Phase deviation is less than  $0^{\circ}$ , the system will adjust the Phase deviation to  $0^{\circ}$  automatically.

**46. PM Frequency upper limit=20kHz**

In internal PM, the PM Frequency upper limit is 20 kHz. If the specified PM Frequency is higher than 20 kHz, the system will adjust the PM Frequency to 20 kHz automatically.

**47. PM Frequency lower limit=2mHz**

In internal PM, the PM Frequency lower limit is 2mHz. If the specified PM Frequency is lower than 2mHz, the system will adjust the PM Frequency to 2mHz automatically.

**48. Set Start Frequency to Max.**

In Sweep mode, if the specified Start Frequency is higher than the Max value, this message will appear.

**49. Set Start Frequency to Min.**

In Sweep mode, if the specified Start Frequency is lower than the Min value, this message will appear.

**50. Set Stop Frequency to Max.**

In Sweep mode, if the specified Stop Frequency is higher than the Max value, this message will appear.

**51. Set Stop Frequency to Min.**

In Sweep mode, if the specified Stop Frequency is lower than the Min value, this message will appear.

**52. Set Center Frequency to Max.**

In Sweep mode, if the specified Center Frequency is higher than the Max value, this message will appear.

**53. Set Center Frequency to Min.**

In Sweep mode, if the specified Center Frequency is lower than the Min value, this message will appear.

**54. Set Frequency Span to Max.**

In Sweep mode, if the specified Frequency Span is higher than the Max value, this message will appear.

**55. Set Frequency Span to Min.**

In Sweep mode, if the specified Frequency Span is lower than the Min value, this message will appear.

**56. Sweep Time upper limit=500s**

The Sweep Time upper limit is 500s. If the specified Sweep Time is greater than 500s, the system will adjust the Sweep Time to 500s automatically.

**57. Sweep Time lower limit=1.0ms**

The Sweep Time lower limit is 1.0ms. If the specified Sweep Time is less than 1.0ms, the system will adjust the Sweep Time to 1.0ms automatically.

**58. Sweep has been turned off to allow Pulse.**

When  Sweep is on, if you press  Pulse, this message will appear, then the Sweep is turned off to allow Pulse settings.

**59. Sweep has been turned off to allow Noise.**

When  Sweep is on, if you press  Noise, this message will appear, then the Sweep is turned off to allow Noise settings.

**60. Sorry, unable to Sweep Pulses.**

Pulse cannot be used to generate sweep signals. When  Pulse is on, if you press  Sweep, this message will appear.

**61. Sorry, unable to Sweep Noise.**

Noise cannot be used to generate sweep signals. When  Noise is on, if you press  Sweep, this message will appear.

**62. Start Phase upper limit= +180°**

In the Gated mode, the Phase upper limit is +180°. If the specified Phase is greater than +180°, the system will adjust the Phase to +180° automatically.

**63. Start Phase lower limit= -180°**

In the Gated mode, the Phase lower negative limit is  $-180^{\circ}$ . If the specified Phase is less than  $-180^{\circ}$ , the system will adjust the Phase to  $-180^{\circ}$  automatically.

**64. #of Cycle upper limit=50000Cyc**

In the N-Cycle mode, the Cycle upper limit is 50000Cyc. If the specified Cycle is greater than 50000Cyc, the system will adjust the Cycle to 50000Cyc automatically.

**65. #of Cycle upper limit=1Cyc**

In the N-Cycle mode, the Cycle lower limit is 1Cyc. If the specified Cycle is less than 1Cyc, the system will adjust the Cycle to 1Cyc automatically.

**66. Start Phase upper limit= + 180°**

In the N-Cycle mode, the Start Phase upper limit is  $180^{\circ}$ , if the specified phase is greater than  $180^{\circ}$ , the system will adjust the Start Phase to  $180^{\circ}$  automatically.

**67. Start Phase lower limit=-180°**

In the N-Cycle mode, the Start Phase upper limit is  $-180^{\circ}$ , if the specified phase is less than  $-180^{\circ}$ , the system will adjust the Start Phase to  $-180^{\circ}$  automatically.

**68. Trigger Period upper limit=500s**

In the N-Cycle mode, the Trigger Period upper limit is 500s. If the specified Trigger Period is greater than 500s, the system will adjust the Trigger Period to 500s automatically.

**69. Trigger Period lower limit=1μs**

In the N-Cycle mode, the Trigger Period lower limit is 1.0μs. If the specified Trigger Period is less than 1.0μs, the system will adjust the Trigger Period to 1.0μs automatically.

**70. Delay upper limit=40s**

In the N-Cycle mode, the Delay upper limit is 40.0s. If the specified Delay is greater than 40.0s, the system will adjust the Delay to 40.0s automatically.

**71. Delay lower limit=0s**

In the N-Cycle mode, the Delay lower limit is 0s. If the specified Delay is less than 0s, the system will adjust the Delay to 0s automatically.

**72. Start Phase upper limit= + 180°**

In the **infinite** mode, the Start Phase upper limit is  $180.0^{\circ}$ . If the specified Start Phase is greater than  $180.0^{\circ}$ , the system will adjust the Start Phase to  $180.0^{\circ}$  automatically.

**73. Start Phase lower limit=-180°**



In the **infinite** mode, the Start Phase lower limit is  $-180.0^\circ$ . If the specified Start Phase is less than  $-180.0^\circ$ , the system will adjust the Start Phase to  $-180.0^\circ$  automatically.

**74. Delay upper limit=40s**

In the **infinite** mode, the Delay time upper limit is 40s. If the specified time is greater than 40s, the system will adjust the Delay time to 40s automatically.

**75. Delay lower limit=0s**

In the **infinite** mode, the Delay time lower limit is 0s. If the specified time is less than 0s, the system will adjust the Delay time to 0s automatically.

**76. Offset upper limit=10V**

When "DC" is selected in **Arb**, the DC offset upper limit is 10V. If the specified offset is higher than 10V, the system will adjust the DC offset to 10V automatically.

**77. Offset lower limit=-10V**

When "DC" is selected in **Arb**, the DC offset lower limit is -10V. If the specified offset is lower than -10V, the system will adjust the DC offset to -10V automatically.

**78. Load impedance upper limit=10k $\Omega$**

When DC output is off, the Load Impedance upper limit is 10k $\Omega$ . If the specified Load Impedance is greater than 10k $\Omega$ , the system will adjust the Load Impedance to 10k $\Omega$  automatically.

**79. Load impedance lower limit=1 $\Omega$**

When DC output is off, the Load Impedance lower limit is 1 $\Omega$ . If the specified Load Impedance is less than 1 $\Omega$ , the system will adjust the Load Impedance to 1 $\Omega$  automatically.

**80. Start Phase upper limit=+180 $^\circ$**

When DC output is off, the Start Phase upper limit is 180 $^\circ$ . If the specified phase is greater than 180 $^\circ$ , the system will adjust the Start Phase to 180 $^\circ$  automatically.

**81. Start Phase lower limit=-180 $^\circ$**

When DC output is off, the Start Phase lower limit is -180 $^\circ$ . If the specified phase is less than -180 $^\circ$ , the system will adjust the Start Phase to -180 $^\circ$  automatically.

**82. The biggest light level is 31!**

The biggest light level is 31. If the specified light level is greater than 31, the system will adjust the light level to 31 automatically.

**83. The smallest light level is 0!**

The smallest light level is 0. If the specified light level is less than 0, the system will adjust the light level to 0 automatically.

**84. The biggest contrast level is 31!**

The biggest contrast level is 31. If the specified contrast level is greater than 31, the system will adjust the contrast level to 31 automatically.

**85. The smallest contrast level is 0!**

The smallest contrast level is 0. If the specified contrast level is less than 0, the system will adjust the contrast level to 0 automatically.

**(\*\*\* denotes that the message will be different based on different setting.)**

---

## Troubleshooting

- 1. If the screen does not turn on even if the generator is on, please follow the steps below:**
  - (1) Check if the power is correctly connected.
  - (2) Check if the power switch is really on.
  - (3) Restart the instrument after taking the above steps.
  - (4) If it does not work correctly, contact **RIGOL** for our service.
  
- 2. If the settings are correct but no waveform is generated, please follow the steps below:**
  - (1) Check if the Signal Line is correctly connected to the [Output] terminal.
  - (2) Check if the BNC works correctly.
  - (3) Check if the Output button has been turned on.
  - (4) Select PowOn → Latest, when all the above steps have been finished. Restart the instrument.



## Chapter 5 Specifications

All the specifications apply to the DG1000 series Dual-Channel Function/ Arbitrary Waveform Generator unless specified statement. To meet these specifications, two conditions must be satisfied first:

- The instrument must have operated continuously for more than 30 minutes within the specified operating temperature (18°C ~ 28°C).
- Variation of the operating temperature should be within 5 °C.

All specifications are guaranteed unless noted "typical".

## Characteristics

Frequency		
Waveforms	Sine, Square, Ramp, Pulse, Noise, Arb	
	<b>DG1022</b>	<b>DG1022A</b>
Sine	1 $\mu$ Hz ~ 20MHz	1 $\mu$ Hz ~ 25MHz
Square	1 $\mu$ Hz ~ 5MHz	1 $\mu$ Hz ~ 5MHz
Ramp, Triangle	1 $\mu$ Hz ~ 150kHz	1 $\mu$ Hz ~ 500kHz
Pulse	500 $\mu$ Hz ~ 3MHz	500 $\mu$ Hz ~ 5MHz
Noise	5MHz (-3dB)	5MHz (-3dB)
Arb	1 $\mu$ Hz ~ 5MHz	1 $\mu$ Hz ~ 5MHz
Resolution	1 $\mu$ Hz	
Accuracy	$\pm$ 50 ppm in 90 days $\pm$ 100 ppm in 1year 18°C ~ 28°C	
Temperature index	< 5 ppm/°C	

Sine Wave Spectral Purity				
Harmonic Distortion	CH1		CH2	
	$\leq 1V_{PP}$	>1V <sub>PP</sub>	$\leq 1V_{PP}$	>1V <sub>PP</sub>
DC-1MHz	-45dBc	-45dBc	-45dBc	-45dBc
1MHz-5MHz	-45dBc	-40dBc	-45dBc	-40dBc
5MHz-25MHz	-45dBc	-35dBc	-45dBc	-35dBc
Total Harmonic Distortion	DC to 20 kHz, 1V <sub>pp</sub> <0.2%			
Spurious (non-harmonic)	DC to 1 MHz < -70 dBc 1 MHz to 10 MHz < -70 dBc + 6 dB/octave			
Phase Noise	10kHz Offset, -108 dBc / Hz (Typical)			

Square Wave	
Rise/Fall Time	< 20 ns (10% to 90%), (Typical, 1kHz, 1 V <sub>PP</sub> )
Overshoot	< 7.5% (Typical, 1kHz 1V <sub>pp</sub> )
Duty Cycle	1 $\mu$ Hz to 3MHz: 20% to 80%

	3MHz(not contain) to 4MHz: 40% to 60%
	4MHz (not contain) to 5MHz: 50%
Asymmetry (below 50% Duty Cycle)	1% of period+ 20ns (Typical, 1kHz, 1 V <sub>PP</sub> )
Jitter	6ns + 0.1% of period (Typical, 1kHz, 1 V <sub>PP</sub> )

<b>Ramp Wave</b>	
Linearity	< 0.1% of peak output (Typical, 1kHz, 1 V <sub>PP</sub> , 100% Symmetry)
Symmetry	0% to 100%

<b>Pulse Wave</b>	
Pulse Width	2000s max period; 20ns min period; 1ns resolution
Overshoot	< 7.5%
Jitter	6ns + 100ppm of period

<b>Arb Wave</b>	<b>CH1</b>	<b>CH2</b>
Waveform Length	4k points	1k points
Amplitude Accuracy	14 bits (including sign)	10 bits (including sign)
Sample Rate	100MSa/s	100MSa/s
Minimum Rising /Falling Time (Typical)	35ns	35ns
Jitter (RMS) (Typical)	6 ns + 30ppm	6 ns + 30ppm
Non-Volatile Storage (Total:10 Waveforms)	10 waveforms	10 waveforms

<b>Output</b>	<b>DG1022</b>		<b>DG1022A</b>	
	<b>CH1</b>	<b>CH2</b>	<b>CH1</b>	<b>CH2</b>
Amplitude (50 Ω)	2 mV <sub>PP</sub> ~ 10 V <sub>PP</sub>	2 mV <sub>PP</sub> ~ 3 V <sub>PP</sub>	≤20MHz: 2 mV <sub>PP</sub> ~10 V <sub>PP</sub> ; >20MHz: 2 mV <sub>PP</sub> ~5 V <sub>PP</sub> ;	2 mV <sub>PP</sub> ~ 3 V <sub>PP</sub>

**RIGOL**

Accuracy (1kHz Sine) <sup>[1]</sup>	$\pm(2\% \text{ of setting} + 2\text{mV}_{PP})$	
Amplitude Flatness (Sine wave relative to 1kHz, 5V <sub>PP</sub> ) <sup>[1]</sup>	<100kHz:      0.1 dB	<100kHz:      0.1 dB
	100kHz ~ 5MHz: 0.15 dB	100kHz ~ 5MHz: 0.15 dB
	5MHz ~ 20MHz: 0.3 dB	5MHz ~ 25MHz: 0.3 dB

<b>DC Offset</b>	<b>CH1</b>	<b>CH2</b>
Range (DC)	5V (50Ω) 10 V (High Z)	1.5V (50Ω) 3 V (High Z)
Accuracy	$\pm(2\% \text{ of the }  \text{Offset Setting}  + 2\text{mV})$	$\pm(2\% \text{ of the }  \text{Offset Setting}  + 2\text{mV})$

<b>Waveform Output</b>	<b>CH1</b>	<b>CH2</b>
Impedance	50 Ω (Typical)	50 Ω (Typical)
Protection <sup>[2]</sup>	Short-circuit protected, overload relay automatically disables main output	Short-circuit protected

<b>AM (CH1)</b>	
Carrier Waveforms	Sine, Square, Ramp, Arb (Except DC)
Source	Internal/ External
Modulating Waveforms	Sine, Square, UpRamp, DnRamp, Triangle, Noise, Arb (2mHz to 20kHz)
Depth	0% ~ 120%
<b>FM (CH1)</b>	
Carrier Waveforms	Sine, Square, Ramp, Arb (Except DC)
Source	Internal/ External
Modulating Waveforms	Sine, Square, UpRamp, DnRamp, Triangle, Noise, Arb (2mHz to 20kHz)
Frequency Deviation	DC~ 10 MHz
<b>PM (CH1)</b>	
Carrier Waveforms	Sine, Square, Ramp, Arb (Except DC)
Source	Internal/ External
Modulating Waveforms	Sine, Square, UpRamp, DnRamp, Triangle, Noise, Arb (2mHz to 20kHz)



Phase Deviation	0 to 360°
<b>FSK (CH1)</b>	
Carrier Waveforms	Sine, Square, Ramp, Arb (Except DC)
Source	Internal/ External
Modulating Waveforms	50% duty cycle square (2mHz to 50kHz)

<b>Sweep (CH1)</b>	
Carrier Waveforms	Sine, Square, Ramp, Arb (Except DC)
Type	Linear or Logarithmic
Direction	Up or Down
Sweep Time	1 ms to 500 s $\pm$ 0.1%
Source	Internal/External/Manual

<b>Burst (CH1)</b>	
Waveforms	Sine, Square, Ramp, Pulse, Noise, Arb (Except DC)
Types	Count (1 to 50,000 periods), infinite, gated
Start Phase	-180° to +180°
Internal Period	1 $\mu$ s – 500s $\pm$ 1%
Gate Source	External Trigger
Trigger Source	Internal/External/Manual

<b>Rear Panel Connector<sup>[3]</sup></b>	
External Modulation	$\pm$ 5 V <sub>PK</sub> = 100% modulation 10k $\Omega$ input impedance
External Trigger	TTL-compatible

<b>Trigger Input</b>	
Input Level	TTL-compatible
Slope	Rising or falling (selectable)
Pulse Width	> 100 ns
Input Impedance	> 10 k $\Omega$ , DC coupled
Latency	Sweep: < 500 $\mu$ s (Typical)
	Burst: < 500 ns (Typical)

<b>Trigger Output</b>	
Level	TTL-compatible into >1kΩ
Pulse Width	> 400ns (Typical)
Output Impedance	50Ω (Typical)
Maximum Rate	1 MHz

<b>Sync Output (CH1)</b>	
Level	TTL-compatible into >1kΩ
Pulse Width	> 50ns (Typical)
Output Impedance	50Ω (Typical)
Maximum Frequency	2 MHz

<b>Counter Specification</b>			
Function	Frequency, period, positive/negative Pulse width, Duty cycle		
Frequency range	Single channel: 100mHz ~ 200MHz		
Frequency resolution	6 digits/second		
Voltage range and sensitivity (not modulated signal)			
Auto mode	1Hz to 200MHz	200 mV <sub>PP</sub> to 5 V <sub>PP</sub>	
Manual mode	DC	DC offset range	±1.5 VDC
		100mHz~100MHz	20m VRMS to ±5 Vac+dc
		100MHz~200MHz	40m VRMS to ±5 Vac+dc
	AC	1Hz~100MHz	50m V <sub>PP</sub> to ±5 V <sub>PP</sub>
100MHz~200MHz		100m V <sub>PP</sub> to ±5 V <sub>PP</sub>	
Pulse width and Duty cycle measure	1Hz to 10MHz (100mV <sub>PP</sub> ~ 10V <sub>PP</sub> )		
Input adjust	Input impedance		1MΩ
	Coupling mode		AC, DC
	High frequency restrain		High frequency noise restrain (HFR) on or off
	sensitivity		Low, Medium, High
Trigger mode	The trigger level can adjust manually/ automatically		

	Trigger level range: $\pm 3$ V (0.1% to 100%)
	Resolution: 6 mV

**NOTE:**

[1] In atypical condition, the specification may have minor differences.

[2] In normal temperature, short circuit in less than half hour will be tolerable.

- CH1 is provided with **Overvoltage** function. When the output terminal is connected to an external circuit, the relationships between the output voltage "Vout" of generator and the voltage "Vin" possibly generated by external circuit are:

If  $V_{out} \leq 1V_{DC}$ , the protective range of  $V_{in}$  is  $\pm 3V$

If  $V_{out} > 1V_{DC}$ , the protective range of  $V_{in}$  is  $\pm 12.5V$

Thereinto,  $V_{out} = \text{Amplitude}/2 + |\text{Offset}|$ , the Amplitude and Offset are the parameters of the signal outputted from generator.

The generator will cut off the output automatically when  $V_{in}$  exceeds the specified range.

- The voltage inputted to the output connector of CH2 should be within  $\pm 3V$ .

[3] External input voltage should be within  $\pm 5V$ , or else the generator may be damaged.

## General Specifications

<b>Display</b>	
Type	Black and White LCD Screen
Resolution	256 Horizontal x 64 Vertical
Grey Degree	4 Grey Level
Contrast (typical)	150 : 1
Light (typical)	300 nit

<b>Power</b>	
Supply	100-240 VAC <sub>RMS</sub> , 45~440Hz, CAT II
Consumption	Less than 40W
Fuse	2A, T Level , 250V

<b>Environment</b>	
Temperature Range	Operation: 10°C ~ +40°C
	Non-operation: -20°C ~ +60°C
Cooling	Natural cooling
Humidity Range	Below +35°C: ≤90% relative humidity
	+35°C ~ +40°C: ≤60% relative humidity
Height Range	Operation: below 3,000m
	Non-operation: below 15,000m

<b>Instrument Specifications</b>		
Dimension	Width	232mm
	Height	108mm
	Depth	288mm
Weight	Package excluded	2.65kg
	Package Included	4kg

<b>IP Protection</b>
IP2X

<b>Calibration Interval</b>
One year suggested

## Chapter 6 Appendix

### Appendix A: Accessories

#### Standard Accessories:

- A Power Cord that fits the standard of the destination country
- A Quick Guide
- A CD (Including the User' Guide and application software)
- A BNC Cable

#### Optional Accessories:

- BNC to Alligator Clip Cable
- USB Cable
- 40 dB Attenuator
- Power Amplifier

All the accessories (standard and optional) can be purchased by contacting your local **RIGOL** office.

## **Appendix B: Warranty**

**RIGOL** warrants that its products mainframe and accessories will be free from defects in materials and workmanship within the warranty period.

If a product is proven to be defective within the respective period, **RIGOL** guarantees the free replacement or repair of products which are approved defective. To get repair service, please contact with your nearest **RIGOL** sales or service office.

**RIGOL** does not provide other warranty items except the one being provided by this warranty statement. The warranty items include but not being subjected to the hint guarantee items related to tradable characteristic and any particular purpose. **RIGOL** will not take any responsibility in cases regarding to indirect, particular and ensuing damage.

---

## Appendix C: General Care and Cleaning

### General Care

Do not store or leave the instrument in where the instrument will be exposed to direct sunlight for long periods of time.

### Caution

To avoid damages to the instrument, do not expose it to liquids which have causticity.

### Cleaning

Clean the instrument and according to its operating conditions require. To clean the exterior surface, perform the following steps:

1. Disconnect the instrument from all power sources.
2. Clean the loose dust on the outside of the instrument with a lint- free cloth (with a mild detergent and water). When clean the LCD, take care to avoid scarifying it.



**WARNING:** To avoid injury resulting from short circuit, make sure the instrument is completely dry before reconnecting into a power source.

---