

# **RIGOL**

## **User's Guide**

### **DP1116A**

### **Programmable DC Power Supply**

**Feb. 2014**

**RIGOL Technologies, Inc.**



# Guaranty and Declaration

## Copyright

© 2010 RIGOL Technologies, Inc. All Rights Reserved.

## Trademark Information

**RIGOL** is a registered trademark of RIGOL Technologies, Inc.

## Publication Number

UGH02106-1110

## Notices

- **RIGOL** products are protected by patent law in and outside of P.R.C.
- **RIGOL** Technologies, Inc. reserves the right to modify or change parts of or all the specifications and pricing policies at company's sole decision.
- Information in this publication replaces all previously corresponding material.
- **RIGOL** shall not be liable for losses caused by either incidental or consequential in connection with the furnishing, use or performance of this manual as well as any information contained.
- Any part of this document is forbidden to copy or photocopy or rearrange without prior written approval of **RIGOL**.

## Product Certification

**RIGOL** guarantees this product conforms to the national and industrial standards in China as well as the ISO9001:2008 standard and the ISO14001:2004 standard. Other international standard conformance certification is in progress.

## Contact Us

If you have any problem or requirement when using our products or this manual, please contact **RIGOL**.

E-mail: [service@rigol.com](mailto:service@rigol.com)

Website: [www.rigol.com](http://www.rigol.com)

# Safety Requirement

## General Safety Summary

Please review the following safety precautions carefully before putting the instrument into operation so as to avoid any personal injuries or damages to the instrument and any product connected to it. To prevent potential hazards, please use the instrument only specified by this manual.

### **Use Proper Power Cord.**

Only the power cord designed for the instrument and authorized for use within the local country could be used.

### **Ground The Instrument.**

The instrument is grounded through the Protective Earth lead of the power cord. To avoid electric shock, it is essential to connect the earth terminal of power cord to the Protective Earth terminal before any inputs or outputs.

### **Connect the Probe Correctly.**

If a probe is used, do not connect the ground lead to high voltage since it has the isobaric electric potential as ground.

### **Observe All Terminal Ratings.**

To avoid fire or shock hazard, observe all ratings and markers on the instrument and check your manual for more information about ratings before connecting.

### **Use Proper Overvoltage Protection.**

Make sure that no overvoltage (such as that caused by a thunderstorm) can reach the product, or else the operator might expose to danger of electrical shock.

### **Do Not Operate Without Covers.**

Do not operate the instrument with covers or panels removed.

### **Do Not Insert Anything into the Holes of Fan.**

Do not insert anything into the holes of the fan to avoid damaging the instrument.

**Use Proper Fuse.**

Please use the specified fuses.

**Avoid Circuit or Wire Exposure.**

Do not touch exposed junctions and components when the unit is powered.

**Do Not Operate With Suspected Failures.**

If you suspect damage occurs to the instrument, have it inspected by qualified service personnel before further operations. Any maintenance, adjustment or replacement especially to circuits or accessories must be performed by **RIGOL** authorized personnel.

**Keep Well Ventilation.**

Inadequate ventilation may cause increasing of temperature or damages to the device. So please keep well ventilated and inspect the intake and fan regularly.

**Do Not Operate in Wet Conditions.**

In order to avoid short circuiting to the interior of the device or electric shock, please do not operate in a humid environment.

**Do Not Operate in an Explosive Atmosphere.**

In order to avoid damages to the device or personal injuries, it is important to operate the device away from an explosive atmosphere.

**Keep Product Surfaces Clean and Dry.**

To avoid the influence of dust and/or moisture in air, please keep the surface of device clean and dry.

**Electrostatic Prevention.**

Operate in an electrostatic discharge protective area environment to avoid damages induced by static discharges. Always ground both the internal and external conductors of the cable to release static before connecting.

**Proper Use of Battery.**

If a battery is supplied, it must not be exposed to high temperature or in contact with fire. Keep it out of the reach of children. Improper change of battery (note: lithium battery) may cause explosion. Use **RIGOL** specified battery only.

**Handling Safety.**

Please handle with care during transportation to avoid damages to buttons, knob interfaces and other parts on the panels.

**Do Not Provide Power for the Active Load.**

In order to avoid the anti-irrigation current which leads to the power control loop out of control and damages the powered device, this power supply can only provide power for the pure load without the current output function.

## Safety Terms and Symbols

**Terms in this Manual.** These terms may appear in this manual:



---

**WARNING**

Warning statements indicate the conditions or practices that could result in injury or loss of life.

---



---

**CAUTION**

Caution statements indicate the conditions or practices that could result in damage to this product or other property.

---

**Terms on the Product.** These terms may appear on the Product:

**DANGER** indicates an injury or hazard may immediately happen.

**WARNING** indicates an injury or hazard may be accessible potentially.

**CAUTION** indicates a potential damage to the instrument or other property might occur.

**Symbols on the Product.** These symbols may appear on the product:



**Hazardous  
Voltage**



**Safety  
Warning**



**Protective  
Earth  
Terminal**



**Chassis  
Ground**



**Test  
Ground**

## Allgemeine Sicherheits Informationen

Überprüfen Sie die folgenden Sicherheitshinweise sorgfältig um Personenschäden oder Schäden am Gerät und an damit verbundenen weiteren Geräten zu vermeiden. Zur Vermeidung von Gefahren, nutzen Sie bitte das Gerät nur so, wie in diesem Handbuch angegeben.

### **Um Feuer oder Verletzungen zu vermeiden, verwenden Sie ein ordnungsgemäßes Netzkabel.**

Verwenden Sie für dieses Gerät nur das für ihr Land zugelassene und genehmigte Netzkabel.

### **Erden des Gerätes.**

Das Gerät ist durch den Schutzleiter im Netzkabel geerdet. Um Gefahren durch elektrischen Schlag zu vermeiden, ist es unerlässlich, die Erdung durchzuführen. Erst dann dürfen weitere Ein- oder Ausgänge verbunden werden.

### **Anschluss eines Tastkopfes.**

Die Erdungsklemmen der Sonden sind auf dem gleichen Spannungspegel des Instruments geerdet. Schließen Sie die Erdungsklemmen an keine hohe Spannung an.

### **Beachten Sie alle Anschlüsse.**

Zur Vermeidung von Feuer oder Stromschlag, beachten Sie alle Bemerkungen und Markierungen auf dem Instrument. Befolgen Sie die Bedienungsanleitung für weitere Informationen, bevor Sie weitere Anschlüsse an das Instrument legen.

### **Verwenden Sie einen geeigneten Überspannungsschutz.**

Stellen Sie sicher, daß keinerlei Überspannung (wie z.B. durch Gewitter verursacht) das Gerät erreichen kann. Andernfalls besteht für den Anwender die Gefahr eines Stromschlages.

### **Nicht ohne Abdeckung einschalten.**

Betreiben Sie das Gerät nicht mit entfernten Gehäuse-Abdeckungen.

### **Betreiben Sie das Gerät nicht geöffnet.**

Der Betrieb mit offenen oder entfernten Gehäuseteilen ist nicht zulässig. Nichts in entsprechende Öffnungen stecken (Lüfter z.B.)

### **Passende Sicherung verwenden.**

Setzen Sie nur die spezifikationsgemäßen Sicherungen ein.

### **Vermeiden Sie ungeschützte Verbindungen.**

Berühren Sie keine unisolierten Verbindungen oder Baugruppen, während das Gerät in Betrieb ist.



**Betreiben Sie das Gerät nicht im Fehlerfall.**

Wenn Sie am Gerät einen Defekt vermuten, sorgen Sie dafür, bevor Sie das Gerät wieder betreiben, dass eine Untersuchung durch qualifiziertes Kundendienstpersonal durchgeführt wird. Jedwede Wartung, Einstellarbeiten oder Austausch von Teilen am Gerät, sowie am Zubehör dürfen nur von **RIGOL** autorisiertem Personal durchgeführt werden.

**Belüftung sicherstellen.**

Unzureichende Belüftung kann zu Temperaturanstiegen und somit zu thermischen Schäden am Gerät führen. Stellen Sie deswegen die Belüftung sicher und kontrollieren regelmäßig Lüfter und Belüftungsöffnungen.

**Nicht in feuchter Umgebung betreiben.**

Zur Vermeidung von Kurzschluß im Geräteinneren und Stromschlag betreiben Sie das Gerät bitte niemals in feuchter Umgebung.

**Nicht in explosiver Atmosphäre betreiben.**

Zur Vermeidung von Personen- und Sachschäden ist es unumgänglich, das Gerät ausschließlich fernab jedweder explosiven Atmosphäre zu betreiben.

**Geräteoberflächen sauber und trocken halten.**

Um den Einfluß von Staub und Feuchtigkeit aus der Luft auszuschließen, halten Sie bitte die Geräteoberflächen sauber und trocken.

**Schutz gegen elektrostatische Entladung (ESD).**

Sorgen Sie für eine elektrostatisch geschützte Umgebung, um somit Schäden und Funktionsstörungen durch ESD zu vermeiden. Erden Sie vor dem Anschluß immer Innen- und Außenleiter der Verbindungsleitung, um statische Aufladung zu entladen.

**Die richtige Verwendung des Akku.**

Wenn eine Batterie verwendet wird, vermeiden Sie hohe Temperaturen bzw. Feuer ausgesetzt werden. Bewahren Sie es außerhalb der Reichweite von Kindern auf. Unsachgemäße Änderung der Batterie (Anmerkung: Lithium-Batterie) kann zu einer Explosion führen. Verwenden Sie nur von RIGOL angegebene Akkus.

**Sicherer Transport.**

Transportieren Sie das Gerät sorgfältig (Verpackung!), um Schäden an Bedienelementen, Anschlüssen und anderen Teilen zu vermeiden.

**Vermeiden Sie das Einprägen von Strom und Spannung an den Testklemmen.**

Das DP800 Power Supply kann hierdurch zerstört werden, keine aktive Last. Das DP800 kann nur Strom und Spannungen liefern.

## Sicherheits Begriffe und Symbole

**Begriffe in diesem Guide. Diese Begriffe können in diesem Handbuch auftauchen:**



### **WARNING**

Die Kennzeichnung WARNING beschreibt Gefahrenquellen die leibliche Schäden oder den Tod von Personen zur Folge haben können.



### **CAUTION**

Die Kennzeichnung Caution (Vorsicht) beschreibt Gefahrenquellen die Schäden am Gerät hervorrufen können.

**Begriffe auf dem Produkt. Diese Bedingungen können auf dem Produkt erscheinen:**

**DANGER** weist auf eine Verletzung oder Gefährdung hin, die sofort geschehen kann.

**WARNING** weist auf eine Verletzung oder Gefährdung hin, die möglicherweise nicht sofort geschehen.

**CAUTION** bedeutet, dass eine mögliche Beschädigung des Instruments oder anderer Gegenstände auftreten kann.

**Symbole auf dem Produkt. Diese Symbole können auf dem Produkt erscheinen:**



**GefährlicheS  
pannung**



**Sicherheits-  
Hinweis**



**Schutz-erde**



**Gehäusemasse**



**Erde**

---

## General Care and Cleaning

### General Care:

Do not store or leave the instrument in where the instrument will be exposed to direct sunlight for long periods of time.

### Cleaning:

Clean the instrument regularly according to its operating conditions. To clean the exterior surface, perform the following steps:

1. Disconnect the instrument from all power sources.
2. Clean the loose dust on the outside of the instrument with a lint- free cloth (with a mild detergent or water). When cleaning the LCD, take care to avoid scarifying it.



### CAUTION

To avoid damages to the instrument, do not expose them to liquids which have causticity.

---



### WARNING

To avoid injury resulting from short circuit, make sure the instrument is completely dry before reconnecting to a power source.

---

## Environment Considerations

The following symbol indicates that this product complies with the requirements in WEEE Directive 2002/96/EC.



### **Product End-of-Life Handling**

The equipment may contain substances that could be harmful to the environment or human health. In order to avoid release of such substances into the environment and harmful to human health, we encourage you to recycle this product in an appropriate system that will ensure that most of the materials are reused or recycled appropriately. Please contact your local authorities for disposal or recycling information.

## DP1116A Overview

**RIGOL** DP1116A is a single channel Programmable DC Power Supply with up to 160W power and two output scales. Its excellent performance ensures more pure and stable power output. What's more, its user-friendly interface and keypad bring users a superior experience and its various standard interfaces enables easy remote control of the instrument.

### Main Features:

- 4.3 inch, 16 M true color TFT LCD.
- Single voltage/current output in two scales: 16 V/10 A or 32 V/5 A.
- Low ripple noise: < 350  $\mu$ Vrms/3 mVpp.
- Excellent line regulation rate: < 0.01% + 2 mV (voltage), < 0.01% + 250  $\mu$ A (current).
- Excellent load regulation rate: < 0.01% + 2 mV (voltage), < 0.005% + 250  $\mu$ A (current).
- Overvoltage/Overcurrent protection functions, which can effectively protect the load connected to the instrument by specifying proper overvoltage and overcurrent parameters.
- Two-level overtemperature protection function.
- Store and recall system setups.
- Timing output function, which can support up to 100 groups of timing settings and infinite or specified number of cycles output.
- Waveform display function, which can display the output voltage, current and power waveforms in real time so that the output status of the instrument become clear for users in co-operation with the digital parameters shown near the waveforms.
- Classic display mode: dial plates, classical pointer, clear variation tendency of the voltage, current and power.
- Standard interfaces: USB Device, USB Host, LAN and GPIB (IEEE-488).
- Support USB flash device storage.
- Support remote control via Web.
- Support remote control via SCPI commands.
- Conform to LXI-C class instrument standards (version 1.2).
- Support the built-in help.
- Support panel lock.
- Support Chinese & English interfaces and input.

# Document Overview

## Chapter 1 Quick Start

This chapter introduces the panels and display interface as well as some considerations on first use of DP1116A.

## Chapter 2 Front Panel Reference

This chapter gives the detailed information on function and operating methods of each key on the front panel.

## Chapter 3 Remote Control

This chapter guides you how to control the DP1116A through the remote interfaces.

## Chapter 4 Troubleshooting

This chapter offers some methods to help you solve the possible problems during operations.

## Chapter 5 Specifications

This chapter lists the specifications of DP1116A.

## Chapter 6 Appendix

Information about accessories, services and supports and the like.

**Note:**

For the newest version of this manual please download from this URL:

<http://www.rigol.com>

**The representations of panel keys and menu softkeys of the instrument in this book are:**

**Panel key:** key characters + text box, such as **16V/10A** denotes the selection key of "16V/10A" scale.

**Menu softkey:** menu characters + shading, for example: **Volt** denotes the voltage option under the channel setting menu.

---

# Contents

<b>Guaranty and Declaration .....</b>	<b>I</b>
<b>Safety Requirement .....</b>	<b>II</b>
General Safety Summary .....	II
Safety Terms and Symbols .....	V
Allgemeine Sicherheits Informationen.....	VI
Sicherheits Begriffe und Symbole .....	VIII
General Care and Cleaning .....	IX
Environment Considerations .....	X
<b>DP1116A Overview .....</b>	<b>XI</b>
<b>Document Overview.....</b>	<b>XII</b>
<b>Chapter 1 Quick Start .....</b>	<b>1-1</b>
General Inspection .....	1-2
Front/Rear Panel and User Interface.....	1-3
Front Panel .....	1-3
Rear Panel .....	1-6
User Interface .....	1-7
First Use of DP1116A.....	1-8
Power Requirements .....	1-8
Power-On Check .....	1-9
Output Inspection .....	1-10
Display Mode .....	1-12
<b>Chapter 2 Front Panel Reference.....</b>	<b>2-1</b>
Parameter Input.....	2-2
Constant Voltage Output .....	2-5
Constant Current Output .....	2-8
Overvoltage/Overcurrent Protection .....	2-9
Timing Output.....	2-14
Remote Voltage Sensing.....	2-17
Store and Recall .....	2-19
Utility Settings.....	2-23
I/O Settings .....	2-24
System Settings.....	2-27
Calibrate .....	2-32

Timer Setting .....2-33  
Built-in Help .....2-35  
Key Lock .....2-36

**Chapter 3 Remote Control ..... 3-1**  
Web Control ..... 3-1  
Command Control ..... 3-5

**Chapter 4 Troubleshooting ..... 4-1**

**Chapter 5 Specifications ..... 5-1**

**Chapter 6 Appendix ..... 6-1**  
Appendix A: Accessories ..... 6-1  
Appendix B: Warranty..... 6-2

**Index..... 1**



# Chapter 1 Quick Start

This chapter introduces the front/rear panel, the user interface and announcements during first use of the instrument as well as its display mode.

Subjects in this chapter:

- General Inspection
- Front/Rear Panel and User Interface
  - Front Panel
  - Rear Panel
  - User Interface
- First Use of DP1116A
  - Power Requirements
  - Power-On Check
  - Output Inspection
- Display Mode

## General Inspection

Please inspect your new DP1116A according to the following steps:

### 1. Inspect the shipping container for damage

Keep the damaged shipping container or cushioning material until the contents of the shipment have been checked for completeness and the instrument has passed both electrical and mechanical tests.

The consigner or carrier shall be liable for the damage to instrument resulting from shipment. **RIGOL** would not be responsible for free maintenance/rework or replacement of the unit.

### 2. Inspect the instrument

In case of any damage, or defect, or failure, notify your **RIGOL** Sales Representative.

### 3. Check the accessories

The accessories supplied with the instrument are listed in "**Appendix A: Accessories**". If your contents are incomplete or damaged, please notify your **RIGOL** Sales Representative.

# Front/Rear Panel and User Interface

## Front Panel

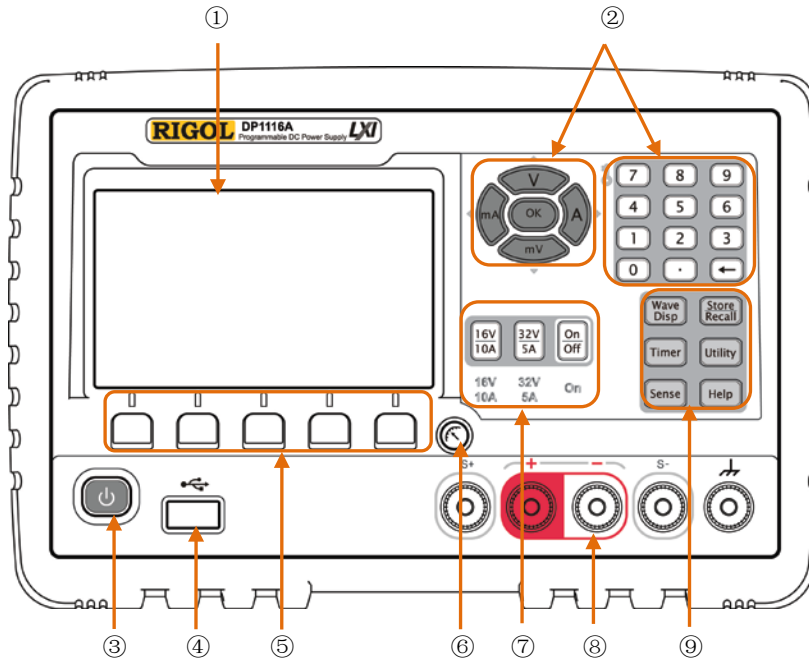



Figure 1-1 Front panel overview

No.	Name	Explanations
①	LCD	Display the user interface
②	Parameter input area	Include the numeric keys, unit keys (direction keys) and enter key
③	Power button	Turn on (or off) the instrument
④	USB Host port	Connect with an external USB device as the "host device"
⑤	Menu key	With different functions in difference menus
⑥	Display modes key	Switch the display mode between <b>General Display Mode</b> and <b>Classic Display Mode</b>
⑦	Scale key	Switch the channel scale, enable/disable the channel output
⑧	Output terminal	Channel output connectors
⑨	Advanced function area	<b>Wave Disp</b> : display the output signal with waveforms

	<p><b>Store/Recall</b>: store and recall the instrument settings</p> <p><b>Timer</b>: control the timing output</p> <p><b>Utility</b>: set the associated system parameters</p> <p><b>Sense</b>: enable the Sense working mode</p> <p><b>Help</b>: enable the built-in help system</p>
--	--

### 1. Panel-key indicator

 The indicator will be lighted and the instrument will be started after you press this button.

**16V/10A**, **32V/5A** The associated characters below the scale key will be highlighted after you press a scale key.

**On/Off** The character below this key will be highlighted after you turn on the channel.

**Wave Disp** The indicator will be lighted after you turn on the waveform display.

**Timer** The indicator will be lighted after you turn on the timer.

**Store/Recall** The indicator will be lighted after you enter the **Store** and **Recall** menu.

**Utility** The indicator will be lighted after you enter the system setting menu.

**Help** The indicator will be lighted after you enable the built-in help system.

### 2. Front panel connectors

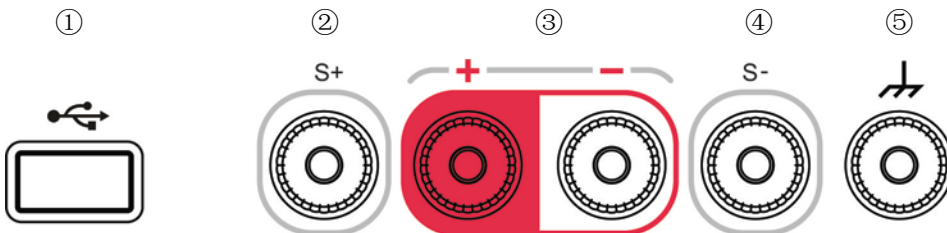

No.	Name	Explanations
①	USB Host	Connect as a "host device" with an external USB device such as USB flash devices.

② ④	Sense terminal	Compensate the voltage drop.
③	Power output terminals	Output the power supply.
④	Earth terminal	This terminal is connected with the chassis and ground wire (grounded through the power cord) and can be used as an additional ground terminal for other devices when the instrument is powered on.

## Rear Panel

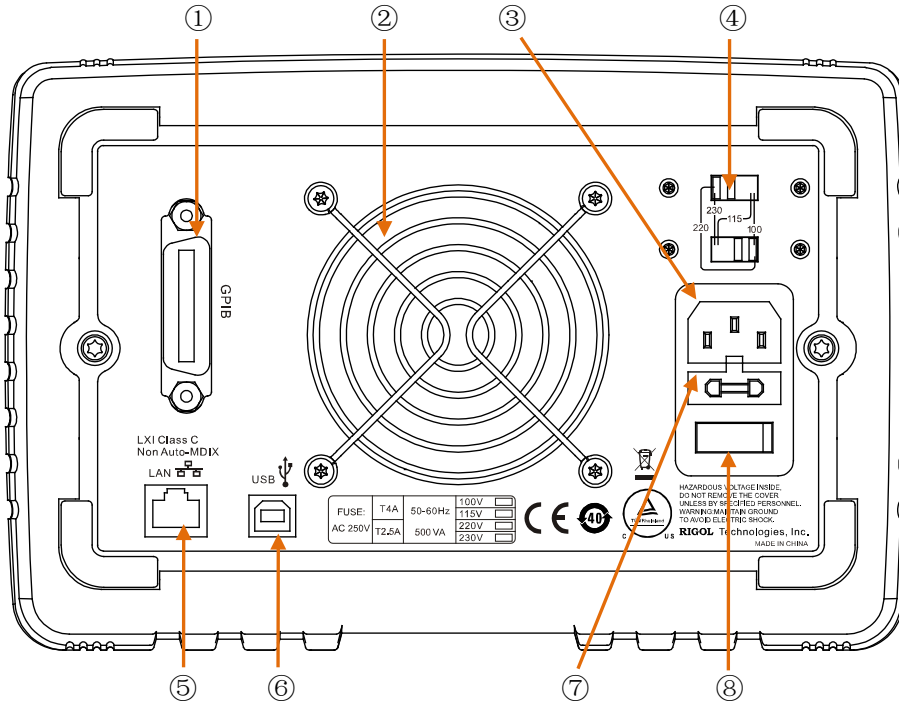

Figure 1-2 Rear panel overview

No.	Name	Explanations
①	GPIB port	Conform to the IEEE 488.2 protocol.
②	Fan	Air outlet.
③	Supply hub	AC power inlet.
④	Power voltage selector	Select a proper scale according to the input voltage manually.
⑤	LAN port	Access to LAN through a RJ45 interface.
⑥	USB device port	Connect as a "slave device" with an external USB device.
⑦	Fuse	Provided with two types of specifications: 250 V, T4 A and 250 V, T2.5 A.
⑧	Power switch	Power on or cut off the power supply.

## User Interface

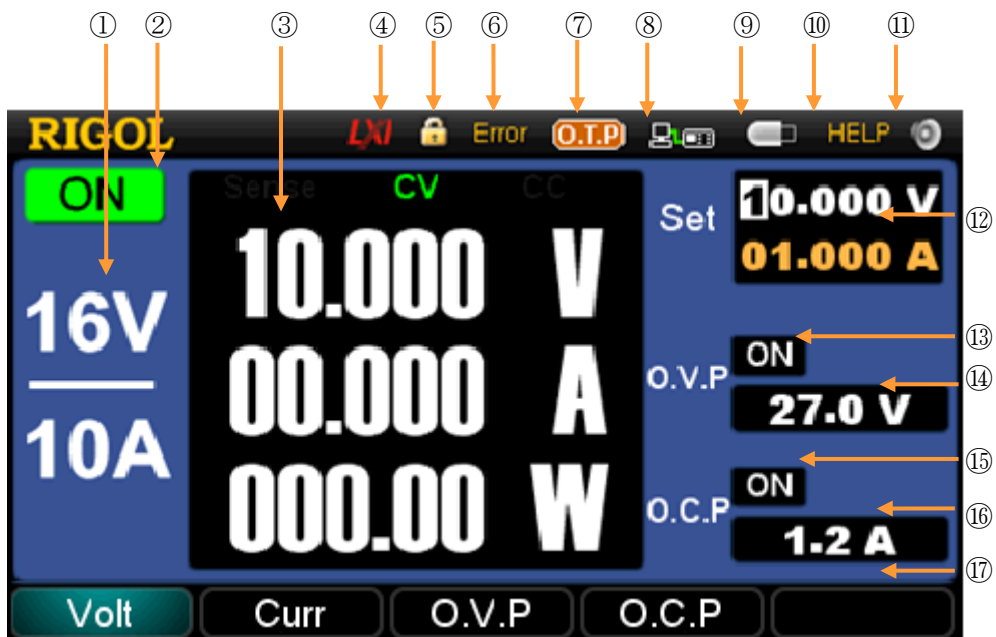

Figure 1-3 User interface of DP1116A

No.	Explanations	No.	Explanations
①	Active channel	⑩	Help system identifier
②	Channel status	⑪	Beeper identifier
③	Actual output *	⑫	Voltage/current input box
④	LAN connection identifier	⑬	O.V.P status setting box
⑤	Keylock	⑭	O.V.P input box
⑥	Self-test failed	⑮	O.C.P status setting box
⑦	O.T.P identifier	⑯	O.C.P input box
⑧	Remote control identifier	⑰	Operation menu
⑨	USB device identifier		

\* **Remark:** This area displays the actual output values of voltage, current and power as well as the identifier of "Sense", "CC" (constant current) or "CV" (constant voltage).

### NOTE

The DP1116A has three display modes and each mode has its own interface, for more details please refer to "**Display Mode**".

## First Use of DP1116A

Prior to making any connections to the instrument, read the section of “General Inspection” carefully to avoid any possible or potential dangers and carry out necessary check and inspections following the requirements below when you first use the DP1116A.

### Power Requirements

Use the power cord that is specifically designed for the DP1116A to connect the instrument and the AC power which delivers 100 V, 115 V, 220 V or 230 V, 50 Hz to 60 Hz. Users should select a voltage scale that meets the standards in their own country through the Power voltage selector (see Figure 1-2) at the rear panel and use an appropriate fuse.

**Note:**

250 V, T4 A fuse: 100 V and 115 V

250 V, T2.5 A fuse: 220 V and 230 V

To change the voltage scale of the instrument, please:

1. Turn off the power switch/button at the front/rear panel and remove the power cord.
2. Check if the fuse (250 V, T2.5 A) installed before leaving factory can match with the selected voltage scale; if not, change it.
3. Regulate the voltage selector to a desired scale using a straight screwdriver.



## Power-On Check

Connect your instrument to the AC supply using the supplied power cord and execute the power-on inspection according to the following steps:

### 1. Turn on the power switch at the rear panel



---

**WARNING**

To avoid electric shock, make sure the instrument has been properly grounded.

---

### 2. Press down the power button

Press down the power button  at the front panel, the instrument starts and executes the self-test and then enters the user interface if the test is successful, or else displays a message like "System selftest is wrong, do you check the error?" on the interface. For more details about this test, press **OK**; or press **Cancel** to exit the message.

## Output Inspection

This function was designed for ensuring that the instrument can make a proper response to every front panel operation and develop its rated outputs. The inspections are mainly centered on the voltage output on the occasion of no loads and the short circuit current output from each scale.

### 1. Channel selection and output switch

See figure below, the front panel has two scale keys (**16V/10A** and **32V/5A**) and a switch key **On/Off**.

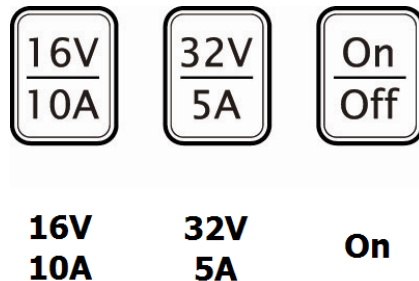



Figure 1-4 Scale keys and switch key

The instrument only allows users to set one output scale at a time. If you press **16V/10A** or **32V/5A**, the characters below the pressed key will be highlighted and the screen will automatically switch into the corresponding setting interface. To turn on the output of the selected scale, press **On/Off** and the character “On” below this key will also be highlighted; to turn off the output, repress this key.

### 2. Voltage output inspection

- (1) Press  and make sure that the Current setting value of each scale is none-zero when the instrument is under no load running.
- (2) Inspect the voltage function of the **16V/10A** scale:  
Press **16V/10A** → **On/Off** and you will see a character “CV” shown on the screen, which indicates the channel you opened is in Constant Voltage output mode. Then check if the voltage in this scale can be set from 0 to 16.8 V (maximum rating). For how to enter the parameter please refer to “**Parameter**”

**Input**" (hereinafter inclusive).

- (3) Inspect the voltage function of the **32V/5A** scale:

Press **32V/5A** → **On/Off** and you will see a character "CV" shown on the screen, which indicates the channel you opened is in Constant Voltage output mode. Then check if the voltage in this scale can be set from 0 to 33.6 V (maximum rating).

### 3. Current output inspection

- (1) Press the power button .

- (2) Inspect the current function of the **16V/10A** scale:

- Use an isolated test lead to short-circuit the positive (+) and negative (-) terminals of **16V/10A**.
- Press **16V/10A**.
- Set the voltage to 16 V.
- Press **On/Off** and inspect if the current in this scale can be set from 0 to 10.5 A (maximum rating).

- (3) Inspect the current function of the **32V/5A** scale:

- Use an isolated test lead to short-circuit the positive (+) and negative (-) terminals of **32V/5A**.
- Press **32V/5A**.
- Set the voltage to 32 V
- Press **On/Off** and inspect if the current in this scale can be set from 0 to 5.25 A (maximum rating).

## Display Mode

The DP1116A is designed with three display modes: **General Display Mode**, **Waveform Display Mode** and **Classic Display Mode**. Under the first two display modes, the interfaces of different scales use different colors (**16V/10A**: blue; **32V/5A**: red). Users can choose an optimal display mode as required.

### 1. General Display Mode

This is the default display mode after you start the instrument. See figure below, in this mode, the setting values of the voltage, current and power are displayed in digital form and you can set the values of O.V.P and O.C.P.



Figure 1-5 General display mode

### 2. Waveform Display Mode

Press **Wave Disp** to enter the waveform display mode. In this mode, the voltage, current and power are shown in two forms of digits and waves so that users can catch the output status of the instrument easily. Besides, you can set the values of O.V.P and O.C.P as required.

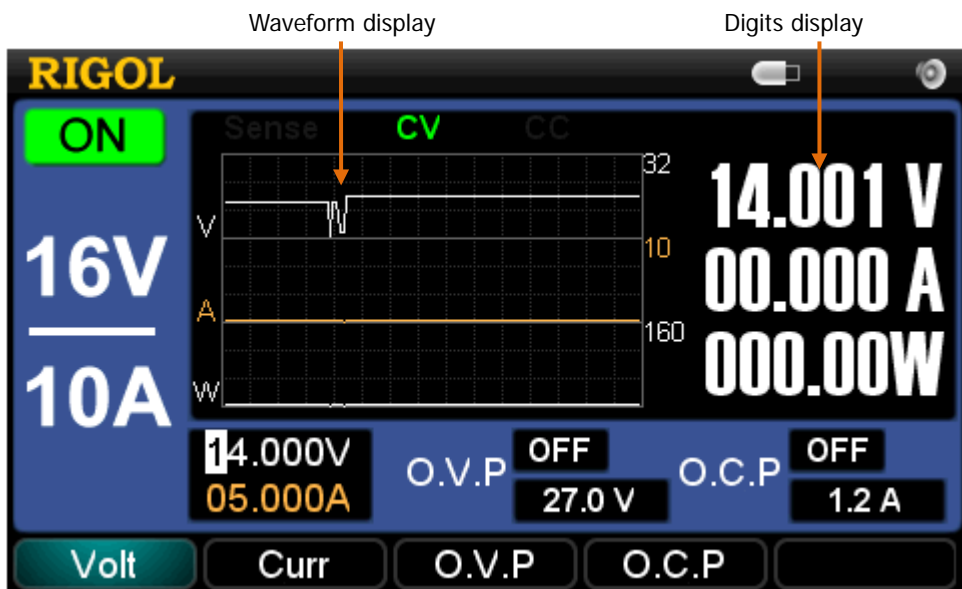



Figure 1-6 Waveform display mode

### 3. Classic Display Mode

The unique dial design and delicate interface layout in this mode enable users to view the assignable ranges and setting values of the voltage (V), current (A) and power (W), you can press  to switch to this mode regardless of the current display mode.

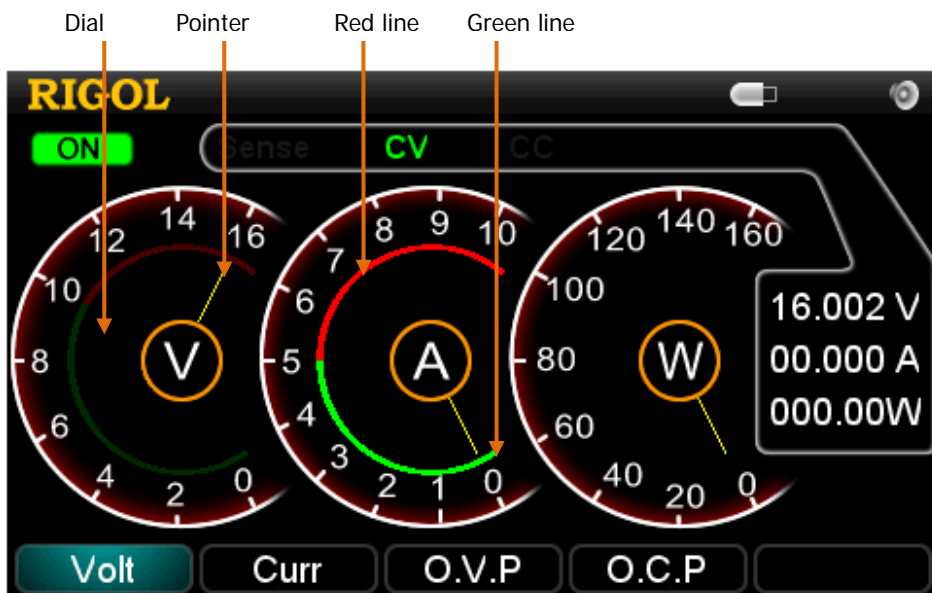

Figure 1-7 Classic display mode

**(1) Dial**

See figure above, the graduations on the three dials represent the assignable ranges of voltage, current and power respectively. Different output scales have different assignable ranges, and thus correspond to different graduations.

- 16V/10A: "V" ranges from 0 to 16, "A" ranges from 0 to 10.
- 32V/5A: "V" ranges from 0 to 32, "A" ranges from 0 to 5.
- In any scale, "W" ranges from 0 to 160.

**(2) Pointer**

The numbers pointed by pointer in the figure above are the current setting values.

**(3) Red/Green line**

See Figure 1-7, values at the connections of the red and green lines in "V" and "A" dials are setting values of O.V.P and O.C.P respectively. Turning on the O.V.P or O.C.P function will protect the circuit when the actual voltage or current reaches its setting value, and the corresponding red and green lines in the dial will be highlighted at the same time.

## Chapter 2 Front Panel Reference

This chapter describes in detail the function keys at the front panel and associated pull down menus.

Subjects in this chapter:

- Parameter Input
- Constant Voltage Output
- Constant Current Output
- Overvoltage/Overcurrent Protection
- Timing Output
- Remote Voltage Sensing
- Store and Recall
- Utility Settings
  - I/O Settings
  - System Settings
  - Calibrate
  - Timer Setting
- Built-in Help
- Key Lock

## Parameter Input

The DP1116A contains two methods of parameter input: **Pop-up box input** and **Direct input (modify)**. All parameters have to be entered by using the numeric keys and unit (direction) keys, see figures below:

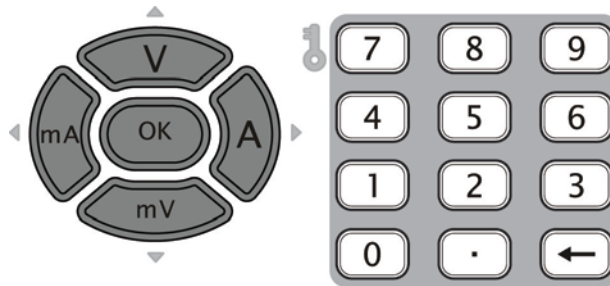

Figure 2-1 Unit (direction) keys (left) and numeric keys (right)

**1. Pop-up box input:** this method applies to the following parameter inputs.

(1) Voltage and Current setting

- Press **Volt** or **Curr** at the front panel.
- Enter a desired value into the pop-up box by using the numeric keys\*.
- Select a unit for the value you entered from the units shown on the menu or at the front panel: V, mV, A or mA.
- Then the instrument will automatically use this value as the setting value in connection with the unit you specify.

\***Remark:** You can use "←" key to delete the data entered during the parameter input.



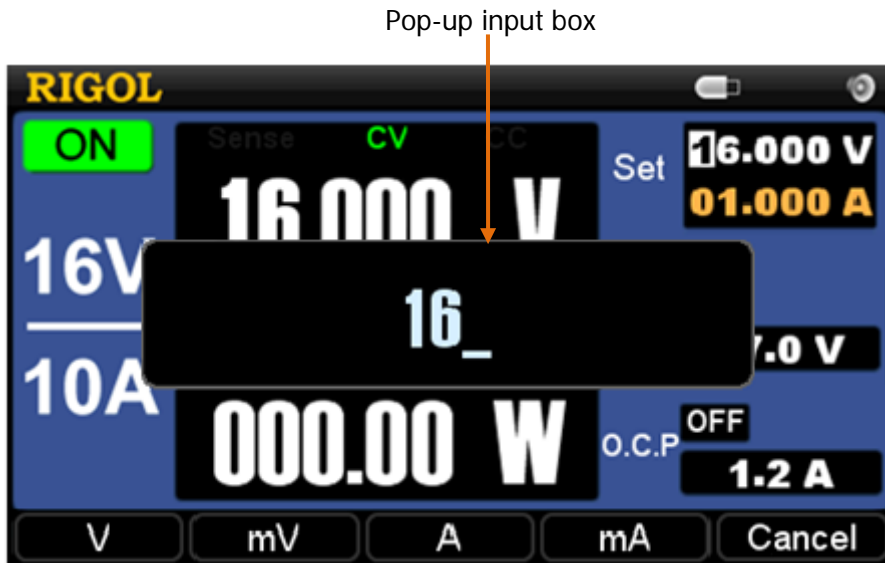

Figure 2-2 Pop-up box input

## (2) O.V.P and O.C.P setting

Press **O.V.P** or **O.C.P** and enter a desired parameter, for the detailed entry method, please refer to **“Voltage and Current setting”**.

## (3) Calibration and Timer setting

Press **Calibrate** or **TimerSet** and enter the desired values. Note that the unit you specify should match with the current parameter, for example, only “mV” or “V” can be used for the voltage you are setting.

## 2. Direct parameter input (modify): this method applies to the following settings.

## (1) Voltage and Current setting

- Switch to the General display mode or Waveform display mode.
- Press the **Volt** or **Curr** panel key at the front panel and the cursor is then moved into the corresponding parameter input box.
- Increase or decrease the voltage or current value displayed at which the cursor is located by pressing the up (**V**) or down (**mV**) direction key. To move the cursor, pressing the left (**mA**) or right (**A**) direction key.



Figure 2-3 Direct parameter input

## (2) Interface setting

Press **I/O** → **LAN** or **GPIB** and enter the corresponding interface data by using the numeric keys. To change the parameter item, press the up or down direction key; to select the item you want, click **OK**; to move the cursor, press the left or right direction key; to delete the parameter you entered, press “←” or the left direction key.

**NOTE**

- Pressing and holding the up or down direction key will rapidly and linearly change the setting value while you set the voltage or current value. To continuously move the cursor, press and hold the left or right direction key.
- To move the cursor in the soft keypad rapidly while you name a file for the storage, press and hold a direction key.

## Constant Voltage Output

The DP1116A has two modes for power output: Constant Voltage output (CV) and Constant Current output (CC). The output mode of the channel is decided by a combination of the specified voltage and current as well as the load connected to the instrument. Neither the output voltage nor the current of the instrument can exceed the specified values. In CV mode, the output voltage equals the specified voltage value; in CC mode, the output current equals the specified current value.

For example: select the **16V/10A** scale and separately set the voltage and current to 16 V and 10 A, then connect a  $2\ \Omega / 300\ \text{W}$  load to the instrument. As  $2\ \Omega \times 10\ \text{A} = 20\ \text{V} > 16\ \text{V}$ , and  $16\ \text{V} / 2\ \Omega = 8\ \text{A} < 10\ \text{A}$ , so the channel outputs the power (16V, 8A) with constant voltage.

### Operation Steps:

1. Connect the output leads: see figure below, connect the output terminals of the instrument with the load.

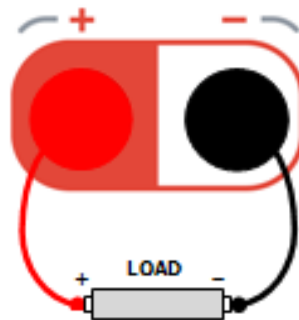

Figure 2-4 Output lead connection

Select a proper output lead following the table below and use a lead as short as possible.

<b>AWG*</b>	10	12	14	16	18	20	22	24	26	28
<b>Max Current (A)</b>	40	25	20	13	10	7	5	3.5	2.5	1.7
<b>mΩ/meter</b>	3.3	5.2	8.3	13.2	21.0	33.5	52.8	84.3	133.9	212.9

\***Remark:** AWG is American Wire Gauge.

**CAUTION**

Wrong connection may cause damages to the instrument or the device connected.

2. Turn on the instrument: press  to start the instrument.
3. Scale selection: press **16V/10A** at the front panel (characters below this key are highlighted).
4. Voltage setting: press **Volt** and set the voltage to 16 V.

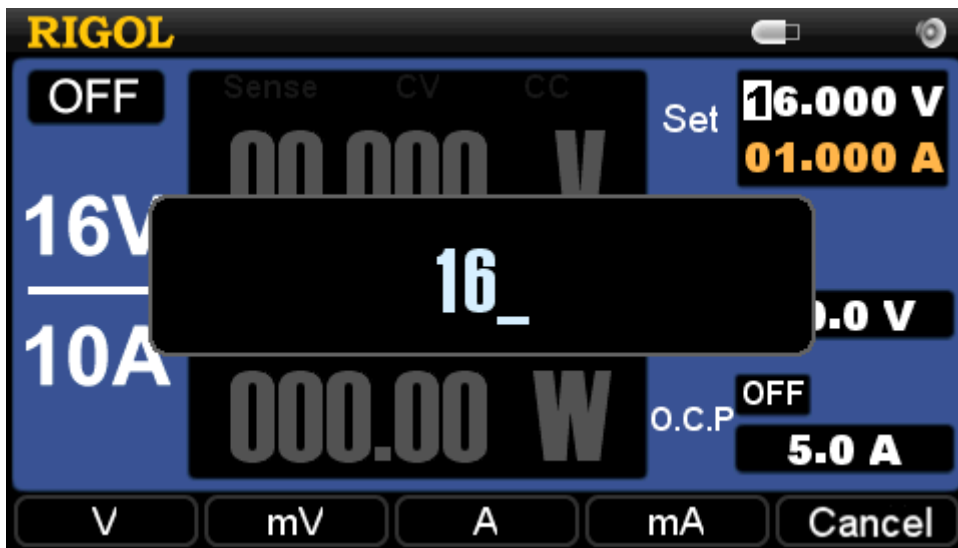

Figure 2-5 Voltage setting

5. Current setting: press **Curr** and set the current to 10 A.

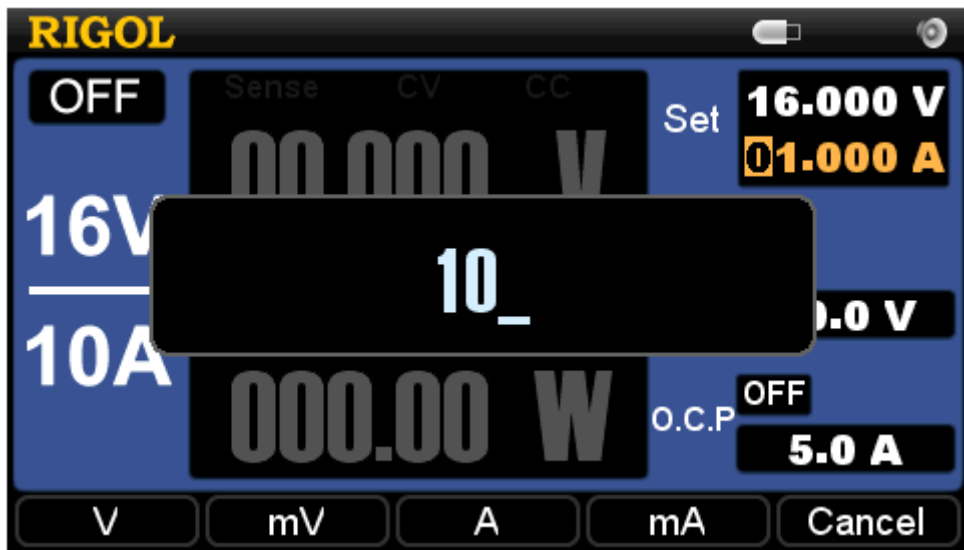

Figure 2-6 Current setting

6. Turn on the output: press **On/Off** (the letter "On" below this key is highlighted) and the instrument will work under CV mode.

**NOTE**

In CV mode, if the output current exceeds the specified value because of the change of the load connected, the instrument will switch into CC mode according to the present setting value of the current and reduce the output voltage proportionally. You can increase the setting value of the current at this moment in order to resume the CV output.

## Constant Current Output

### For example:

Select the **16V/10A** scale and separately set the voltage and current to 16 V and 10 A, then connect a  $1.5 \Omega / 300 \text{ W}$  load to the instrument. As  $1.5 \Omega \times 10 \text{ A} = 15 \text{ V} < 16 \text{ V}$ , and  $16 \text{ V} / 1.5 \Omega = 10.7 \text{ A} > 10 \text{ A}$ , so the channel outputs the power (15 V, 10 A) with constant current.

### Operation Steps:

1. Connect the output leads: connect the output terminals of the instrument with the load as shown in Figure 2-4.



#### CAUTION

Wrong connection may cause damages to the instrument or the device connected.

2. Turn on the instrument: press  to start the instrument.
3. Scale selection: press **16V/10A** on the front panel (characters below this key are highlighted).
4. Voltage setting: press **Volt** and set the voltage to 16 V, see Figure 2-5.
5. Current setting: press **Curr** and set the current to 10 A, see Figure 2-6.
6. Turn on the output: press **On/Off** (the letter "On" below this key is highlighted), the instrument works under CC mode.

#### NOTE

In CC mode, if the output voltage exceeds the specified value because of the change of the load connected, the instrument will switch into CV mode according to the present setting value of the voltage and reduce the output current proportionally. Increasing the setting value of the voltage at this moment will resume the CC output.

## Overvoltage/Overcurrent Protection

In order to keep the power output from exceeding the load rating and avoid damages to the load, the DP1116A was designed with the Overvoltage protection (O.V.P) and Overcurrent protection (O.C.P) functions. Users can set the parameters of the O.V.P and O.C.P optionally and enable or disable these functions as required; if one of these two functions is opened, the instrument will cut off the output once the power output exceeds the setting value of O.V.P or O.C.P so as to effectively protect the load under use.

## O.V.P

The O.V.P contains **Parameter** and **ON/OFF** setting. Please proceed as follows:

### 1. Parameter setting

- Press **16V/10A** or **32V/5A** to select an output scale.
- Press **O.V.P**.
- Enter a value (within 0.1 V and 35.2 V) using the numeric keys and select “V” or “mV” as its unit.
- Observe the variation in the O.V.P input box.

### 2. Enable/Disable the O.V.P

- Press **16V/10A** or **32V/5A** to select an output scale.
- Press **On/Off** to enable the output of the scale you select.
- Press **O.V.P**.
- Press **O.V.P** continuously to switch the state of the O.V.P between ON and OFF. Please note the variation in the O.V.P input box as shown in figure below.



Figure 2-7 O.V.P setting



**NOTE**

- When the channel output is "OFF", the O.V.P function is also disabled, but you can set its parameter.
- The output will be automatically shut off once the output voltage exceeds the specified value of the O.V.P.
- The defaults of the O.V.P status and value are "OFF" and "35.2 V", respectively.

## O.C.P

The O.C.P contains **Parameter** and **ON/OFF** setting. Please proceed as follows:

### 1. Parameter setting

- Press **16V/10A** or **32V/5A** to select an output scale.
- Press **O.C.P**.
- Enter a value (within 0.1 A and 11 A) using the numeric keys and select “A” or “mA” as its unit.
- Observe the variation in the O.C.P input box.

### 2. Enable/Disable the O.C.P

- Press **16V/10A** or **32V/5A** to select an output scale.
- Press **On/Off** to enable the output of the scale you select.
- Press **O.C.P**.
- Press **O.C.P** continuously to switch the state of the O.C.P between ON and OFF. Please note the variation in the O.C.P input box as shown in figure below.



Figure 2-8 O.C.P setting

**NOTE**

- When the channel output is "OFF", the O.C.P function is also disabled, but you can set its parameter.
- The output will be automatically disabled if the output current exceeds the O.C.P value.
- The defaults of the O.C.P status and value are "OFF" and "11A", respectively.

## Timing Output

The DP1116A has Timing Output function. When you enable the timer, the instrument will output the pre-specified voltage, current (up to 100 groups) and simulate the running state of various kinds of power supply more really.

### Operation Steps:

1. Press the **Timer** key at the front panel, then a prompt message like “Timing will change the output of channel possibly, do you go on?” pops up on the screen, if you press **OK**, the backlight of this key will be lighted and a clock icon will be shown on the screen.
2. Turn on the output of the current scale. Then the timer is enabled and the current channel starts outputting until the end of the timing, then the backlight of the **Timer** key goes off.

#### NOTE

- If no parameters are specified by users, pressing **Timer** will first enter the setting interface of “Timer Setting” and the backlight of **Utility** then goes on.
- In the process of timing output, closing the channel output will stop the timer; turning on the channel again will resume the timing output.
- Neither the voltage nor the current can be specified when the timer is on.
- To turn off the timer, repress **Timer**.

See figure below, in General display mode, the “**Set**” option denotes the setting values of the voltage and current output at present; the “**Next**” option denotes the setting values of the voltage and current that will be output at the next fixed time.

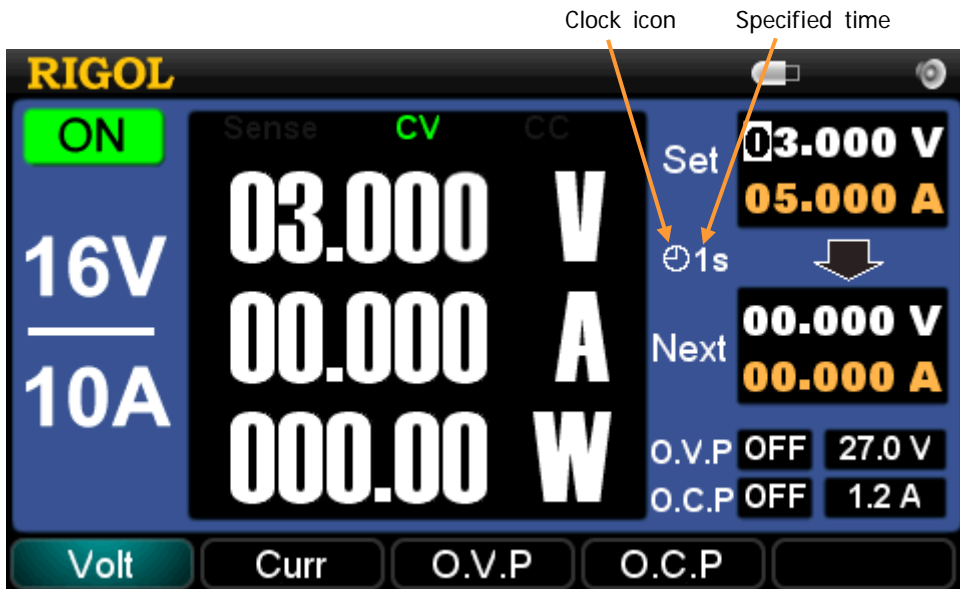

Figure 2-9 Timing output (in General display mode)

See figure below, in Waveform display mode, the timing output can be seen from a waveform.

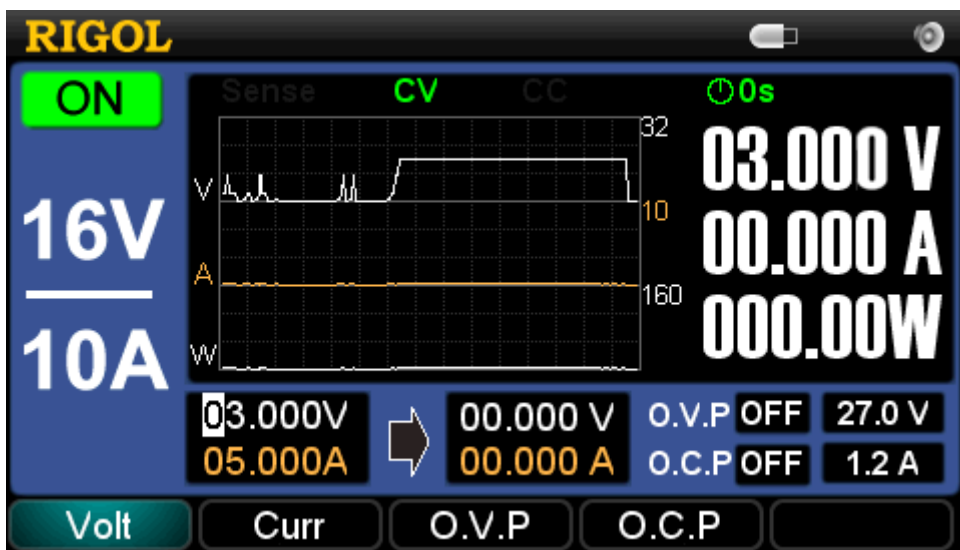

Figure 2-10 Timing output (in Waveform display mode)

See figure below, in Classic display mode, we can directly observe the switching process of the timing output parameters.



Figure 2-11 Timing output (in Classic display mode)

## Remote Voltage Sensing

As the DP1116A can provide 10 A output current and 160W output power, the voltage drop in the load leads must not be disregarded. In order to ensure the accuracy of the voltage drop while outputting a high current, the DP1116A was designed with a Sense (remote sense) function. In Sense mode, the system automatically compensates the voltage drop in the load leads so as to ensure the specified output value can be consistent with the value received by the load. See the connections below.

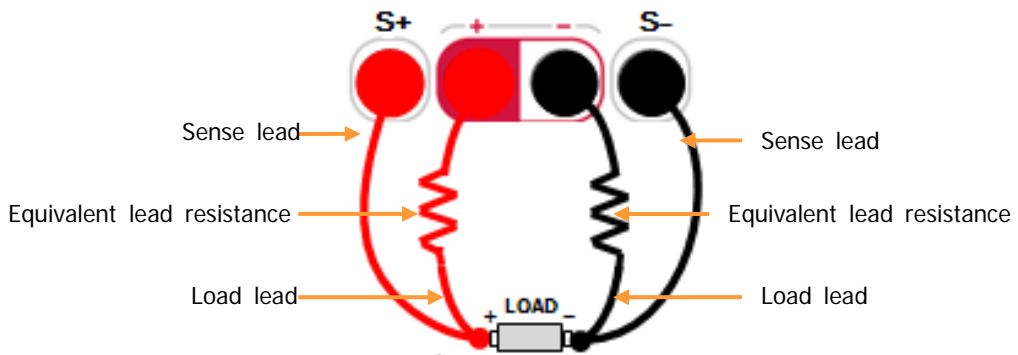

Figure 2-12 Sense connection

### NOTE

- When outputting a high current, the load leads should be as short as possible, and it would be best if the two leads can twist together in order to obtain a better output characteristic.
- Please use a twisted-pair as the Sense lead as possible as you can and the leads should not be twisted with the load leads.

### Operation Steps:

1. Connect the output terminals and the Sense terminals at the front panel of the instrument to both ends of the load as shown in Figure 2-12. Please pay attention to the polarity while connecting.
2. Press **Sense**, the backlight of which goes on and the icon "Sense" is lighted.

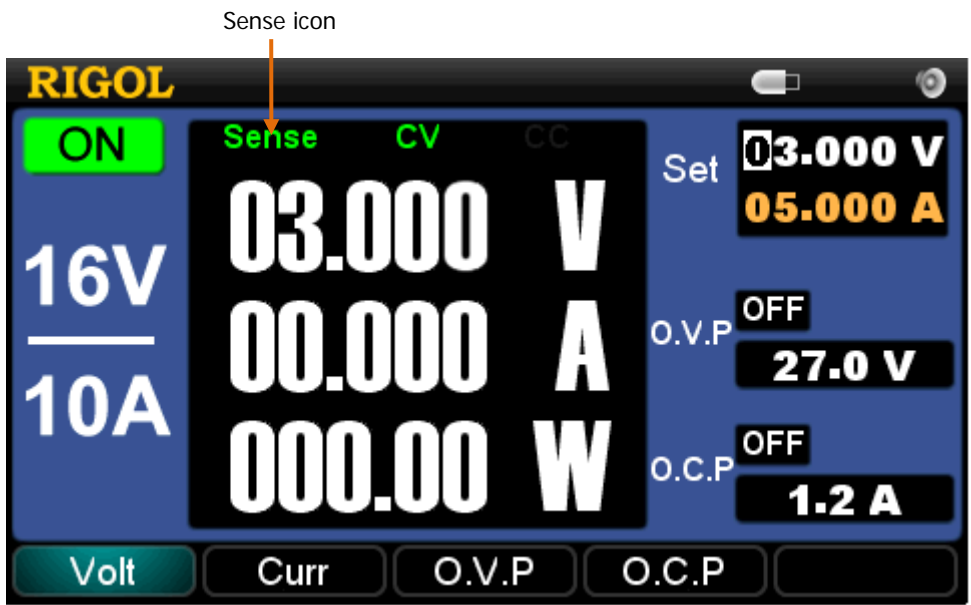

Figure 2-13 Sense status



## Store and Recall

The DP1116A supports operations with a USB flash device and local file memory, including: store, recall and delete the parameters about the voltage, current, O.V.P, O.C.P and other system setting parameters. Besides, you can store and recall up to 4 groups of setting files (STATE1, STATE2, STATE3 or STATE4) in the local memory and more in the USB flash device.

Press the **Store/Recall** at the front panel and enter the interface shown below.

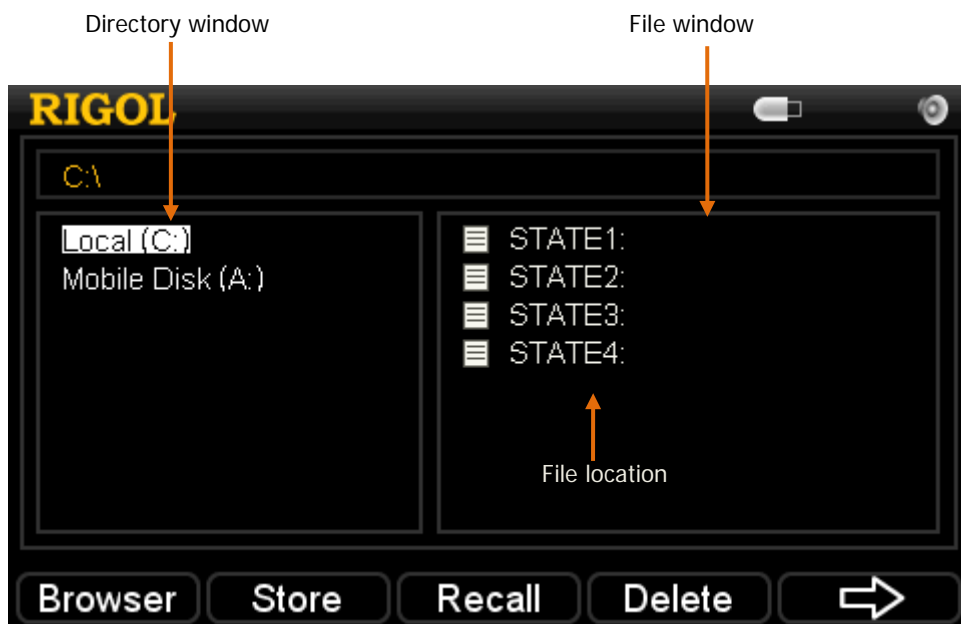

Figure 2-14 Store/Recall interface

Table 2-1 Store/Recall menu explanations

Menu	Explanation
<b>Browser</b>	Switch between the directory window and file window
<b>Store</b>	Enter the storage interface
<b>Recall</b>	Recall the selected system configuration file
<b>Delete</b>	Delete the selected file
➡	Page down
⬅	Page up
<b>Update</b>	Select a desired update file and update the instrument
<b>Exit</b>	Exit the Store/Recall function

In the following part, we will introduce you how to use the Store/Recall function.

### 1. Select a file path

- Press **Browser** and switch to the **directory window**.
- Select the file in “Local (C:)” (local-storage) or “Mobile Disk (A)” (USB storage, if exists) by using the up and down direction keys at the front panel.

### 2. File storage

- Select a file path (take local-storage for example, the method for USB storage is similar).
- Press **Browser** and switch to the **file window**, then select a file location by using the up and down direction keys.
- Press **Store** and input a file name from the interface below.
- Press **Save** to store the file with a specified name and exit.



Figure 2-15 File name entry interface (Chinese)



Figure 2-16 File name entry interface (English)

Table 2-2 File name menu explanations

Menu	Explanation
<b>InType</b>	Select an input type from English and Chinese.
<b>Focus</b>	Switch the cursor position among the file name entry field, virtual soft keypad and the Chinese character display box.
<b>ABC</b> <b>(abc)</b>	Switch between the capital and lower case letters "ABC" supports the lower case letters or pinyin; "abc" supports the capital letters.
<b>Save</b>	Save the system configuration file.
	Return to the home page of Store/Recall.

Next we will illustrate you how to input a file name in Chinese (Example 1) and English (Example 2).

**Example 1:** input “北京普源” as a file name:

- ① Press **InType** and switch to “Ch” input.
- ② Switch to **ABC** and enter a letter “b” from the soft keypad by using direction keys and press **OK**.  
Then, enter “ei” in the same way.
- ③ Press **Focus** and switch to the Chinese character display box and press the up or down direction key until the desired character “北” is displayed and then press the number before this character.  
Then, enter “京普源” in the same way.

**Example 2:** input “Newfile” as a file name:

- ① Press **InType** and switch to “En” input.
- ② Switch to **abc** and enter a letter “N” from the soft keypad by using direction keys and then press **OK**.
- ③ Switch to **ABC** and enter a letter “e” from the soft keypad by using direction keys and then press **OK**.  
Then, enter “wfile” in the same way.

**NOTE**

- Pressing “←” will firstly delete the contents in the Chinese character display box and then the letter before the cursor in the File name entry field in the process of editing.
- The file name should be no more than 6 Chinese characters or 12 letters (include numbers).

**3. File recall**

- Select a file path (take local storage for example).
- Press **Browser**, move the cursor to the file window and select an effective setting file\* by using the up and down direction keys.
- Press **Recall** to recall this file, a message like “File load successful!” will pop up on the screen after the successful load.

\***Remark:** The effective setting file denotes the file with parameters saved (hereinafter inclusive).

**4. File delete**

- Select a file path (take local storage for example).
- Press **Browser**, move the cursor to the file window and select an effective setting file by using the up and down direction keys.
- Press **Delete** and **Sure** to delete this file.

**5. Update**

The DP1116A supports system update through a USB device. After you select a desired file from the USB device, press this key to start the system update.

## Utility Settings

Press **Utility**, the backlight of this key goes on and the instrument enters the associated system setting interface, see figure below:



Figure 2-17 System setting interface

Table 2-3 The System setting interface explanations

Menu	Explanation
I/O	Set or reset the LAN parameter, view the ID number of the USB device, set the GPIB address.
	Set the parameters about the system, including Language, Power-on value, Screen brightness, Overtemperature, Beeper, Self-test and view the system information.
Calibrate	Enter the calibration interface.
TimerSet	Set the timing output parameters about the channel.
Exit	Exit the Utility function.

## I/O Settings

The DP1116A provides three communication interfaces: LAN, USB and GPIB. You can set them upon the I/O menu.

### 1. LAN

Press **I/O**→**LAN** and enter the setting interface shown below:

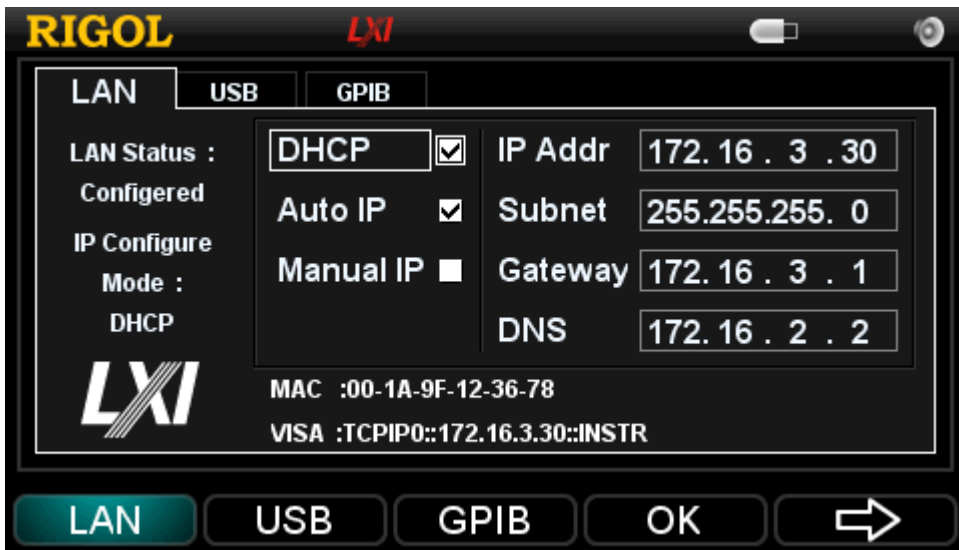

Figure 2-18 LAN setting

Set the IP address:

Choose the IP setting mode from "DHCP", "Auto IP" and "Manual IP" by using the up and down direction keys, then press **OK** to select (with "✓" shown in the related white box) or cancel (the related white box is empty) the related IP setting mode.

**NOTE**

- **DHCP:** parameters such as IP address, Sub Mask and Default Gateway are allocated from the DHCP sever of the current network.
- **Auto IP:** an IP address within 169.254.0.1 and 169.254.255.254 and Sub Mask "255.255.0.0" are obtained automatically according to the current network setting.
- **Manual IP:** parameters such as IP address, Sub Mask, Default Gateway and DNS server are defined by users as desired using the up and down direction keys.
- When the "DHCP", "Auto IP" and "Manual IP" are all selected, the priority level (from high to low) is: DHCP, Auto IP and Manual IP.
- The three settings cannot be all Off – at least one should be On.

Besides, see figure below, you can press **I/O** and go to the second page and press **Default** → **OK** to restore the LAN into the factory defaults.

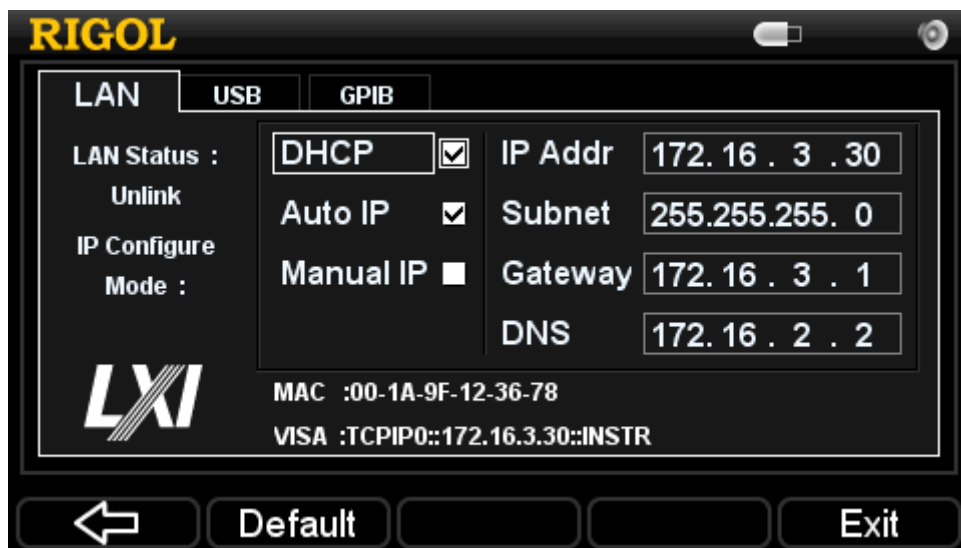

Figure 2-19 LAN defaults

## 2. USB

Press **I/O** → **USB** and enter the following interface, from where you can see the VISA address of the USB Device port on the rear panel (user-defined is unnecessary).



Figure 2-20 USB ID information

3. GPIB

Press **I/O** → **GPIB** and enter the interface shown below. The GPIB address ranges from 1 to 30. You can enter a desired value using the numeric keys and press **OK** to save. To delete the entered digits, press “←” or the left direction key.



Figure 2-21 GPIB address setting



## System Settings

Press  and enter the following menu:



Figure 2-22 System setting menu

### 1. Language

Press **Language** and select a system language from the lower menu options: 中文 (Chinese) and English.

### 2. PowerOn

Press **PowerOn** and enter its setting menu.

If you select "Default", the system will use the factory defaults when restart, see table below.

If you select "Last", the system will use the settings before a power circle.

Table 2-4 Factory defaults explanations

Item	Defaults	Item	Defaults
<b>Scale</b>	32 V / 5 A	<b>LXI function</b>	DHCP: ON Auto IP: ON Manual IP: OFF
<b>Voltage</b>	0 V	<b>GPIO address</b>	25
<b>Current</b>	5 A	<b>Timer parameters</b>	Voltage: 0 Current: 0 CircleNum: 1
<b>O.V.P value</b>	35.2 V	<b>Language</b>	Last setting
<b>O.C.P value</b>	11 A	<b>PowerOn</b>	Default
<b>Channel output</b>	OFF	<b>LCD brightness</b>	6
<b>O.V.P function</b>	OFF	<b>OTP</b>	OFF
<b>O.C.P function</b>	OFF	<b>Beeper</b>	ON
<b>Waveform display</b>	OFF	<b>Web account</b>	Empty

<b>function</b>			
<b>Display mode</b>	General	<b>Web password</b>	Empty
<b>Timer</b>	OFF	<b>Calibration password</b>	Not present
<b>Sense</b>	OFF		

**3. Bright**

Press **Bright** and enter its setting interface. See figure below, you can adjust the screen brightness within 1 and 8 by using the "+" and "-" menu key or left/right direction keys.



Figure 2-23 Screen brightness setting interface



**4. O.T.P**

The DP1116A provides two-level Overtemperature protection function. Pressing **O.T.P** can enable or disable the first level Overtemperature protection function. As shown in figure below, if you turn on the O.T.P, an icon **O.T.P** will be shown on the status bar and the instrument will give you a prompt when the system temperature goes beyond the specified range. The second level protection is always on. If the system temperature reaches its upper limit, the instrument will turn off the channel output.



Figure 2-24 First Level Overtemperature protection setting

### 5. Beeper

Press **Beeper** from the next page of the system main interface and set the status of the beeper. When the beeper is on, an icon  will be shown on the status bar and the instrument will make a buzzing sound once any system message pops up and you will also hear a key tone once a key is pressed down; if the beeper is off, an icon  will be shown on the status bar, see figure below:

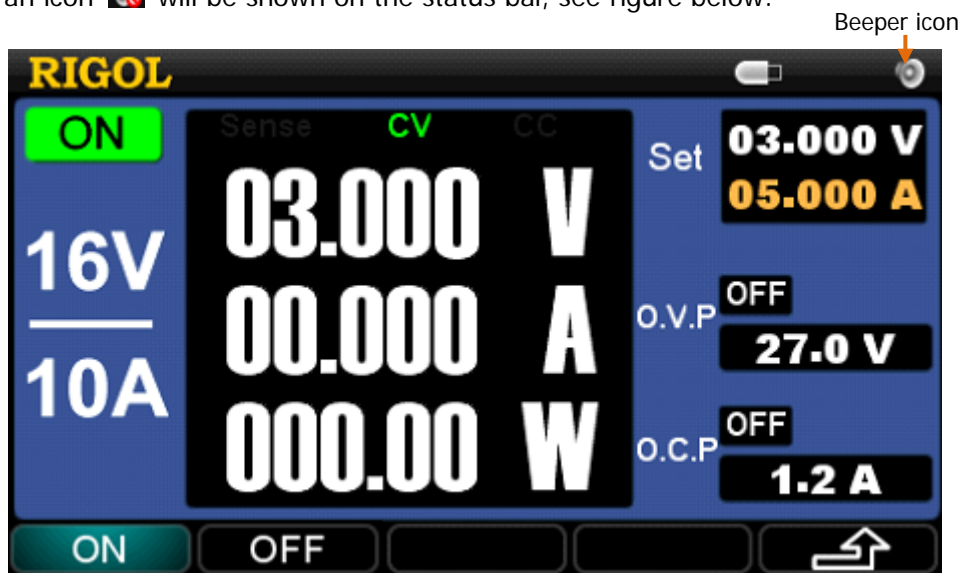

Figure 2-25 Beeper setting

### 6. SelfTest

Press **SelfTest** and enter the setting interface. See figure below, users can execute a self-test and view the related results.



Figure 2-26 Self-test menu

If you press **Result** before any self-test, the results shown under this menu are from the Power-on self-test, see figure below:

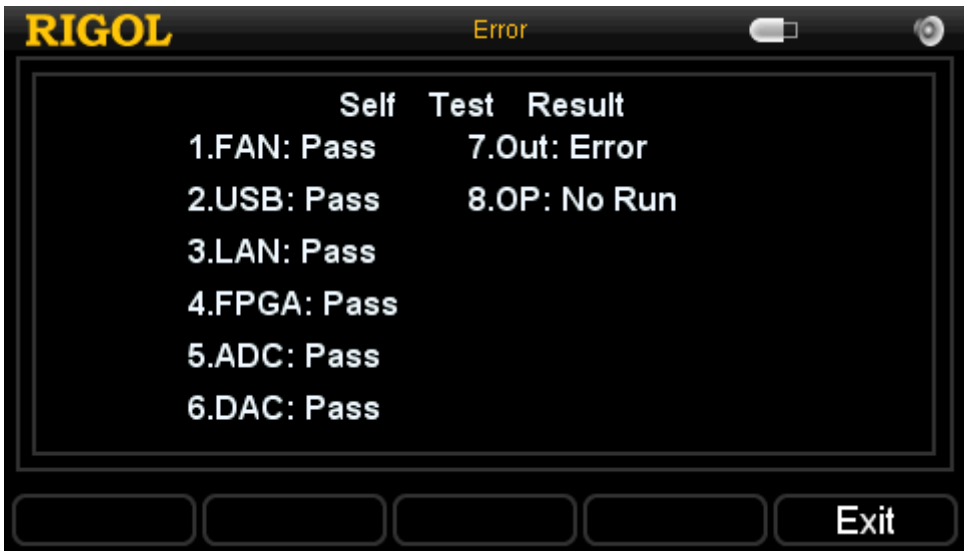

Figure 2-27 Self-test results

## 7. SysInfo

From this menu, you can view the related system information, see figure below:

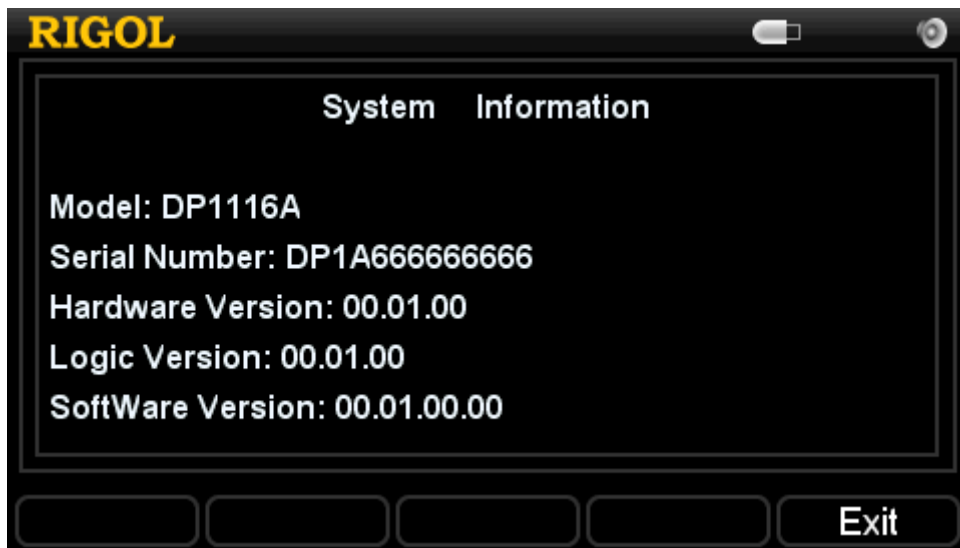

Figure 2-28 System information interface

## Calibrate

Press **Calibrate** and enter the correct password in the pop-up box as shown in figure below.



Figure 2-29 Calibration password entry interface

### NOTE

The instrument has been calibrated before leaving factory. We suggest users not to do a personal calibration. If the calibration must be done for your DP1116A, please contact **RIGOL** technical support.

## Timer Setting

Before enabling the timer, you have to set the parameters about it, including: voltage, current and output time. Both the two scales allow up to 100 groups of timing parameters.

From the figure below, we can see that the timer setting interface is divided into two parts: the waveform display area (left) and the parameter setting area (right).

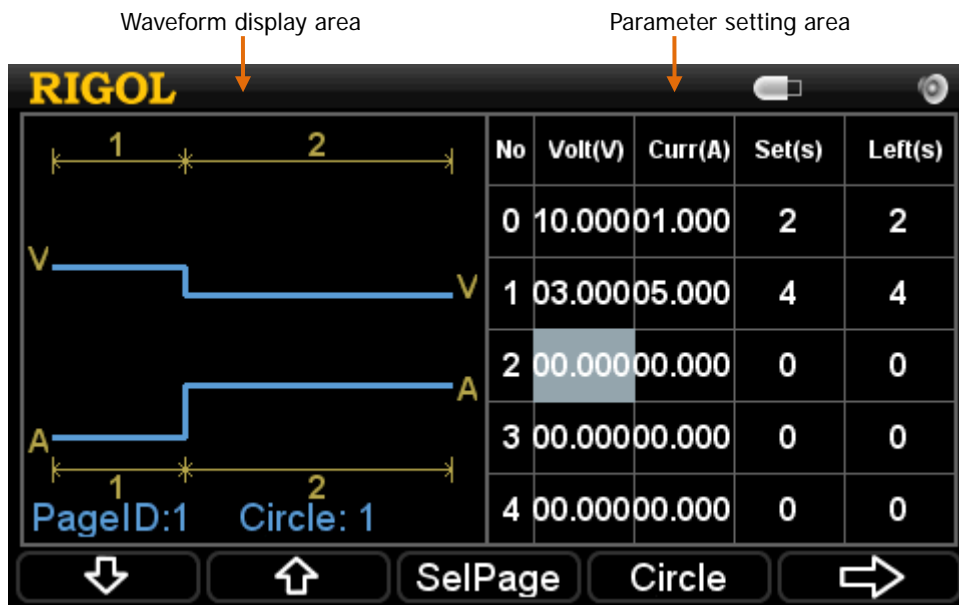



Figure 2-30 Timer setting interface

The right area allows you to specify the voltage (Volt), current (Curr) and output time (Set) for each group and the left area shows the related waveform according to the settings in the right area for users to directly view the output status.

Table 2-5 Timer parameter setting explanations

Menu	Explanation
↓	Go to the next setting page.
↑	Go to the previous setting page.
SelPage	Go to the desired setting page. The total number of pages is 20.
Circle	Set the circle parameters.

	Go to the next menu page.
	Go to the previous menu page.
<b>Save</b>	Store the specified timing parameters into the nonvolatile memory.
<b>Exit</b>	Exit the timer setting with parameters being saved automatically.

**NOTE**

- The value of left time "Left(s)" in the parameter setting is equal to the setting time "Set(s)" when the timer is disabled.
- If the timing parameters have been specified, pressing the **Timer** at the front panel will turn on the timer. When the output is opened, the instrument will start the first group of output and the left time "Left(s)" will decrease gradually till 0; then the instrument will start the second group of output, and the like. The output will stop after all user data has been outputted.



## Built-in Help

The built-in help system enables you to get the help information about each panel key or menu key (except for the numeric keys or direction keys). The design of this function provides facilities for users to use the panel keys or menu keys.

Press **Help**, its backlight goes on and a character like "HELP" is shown on the status bar. Then, press any key (except for the numeric keys or direction keys) and you will see the help information about this key on the screen, at this moment, the backlight goes off and the character "HELP" disappears from the status bar. To exit the help topic you are reading, press **Exit**.

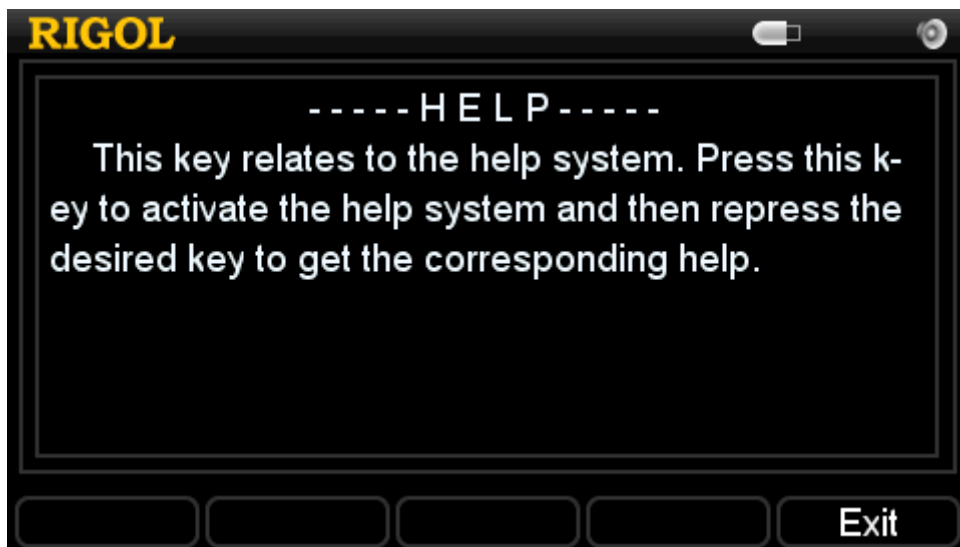



Figure 2-31 Help information



## Key Lock

This function is widely used in the industrial production lines for avoiding error operations.

### 1. Local Mode

In Local mode, holding the number 7 key on the numeric keyboard will lock all keys except the power button  and itself and display an icon  on the screen. To unlock the keys, press and hold the number 7 key again.

### 2. Remote Mode

In Remote mode, all the keys except the power button  and the number 7 key are locked automatically and an icon  is shown on the screen. To exit the remote control, press and hold the number 7 key.

## Chapter 3 Remote Control

The DP1116A Programmable DC Power Supply confirms to the LXI-C standards (1.2) and provides two ways for remote controlling, which are Web and Command.

### Web Control

To control your DP1116A via web LXI page, please follow the instructions below:

#### 1. LAN Setting

Use a Net cable to access your DP1116A into LAN, then press **I/O** → **LAN** to enter the setting interface of LAN (see figure below) and follow the “**I/O Settings**” in Chapter 2 to set the LAN and obtain an IP address.

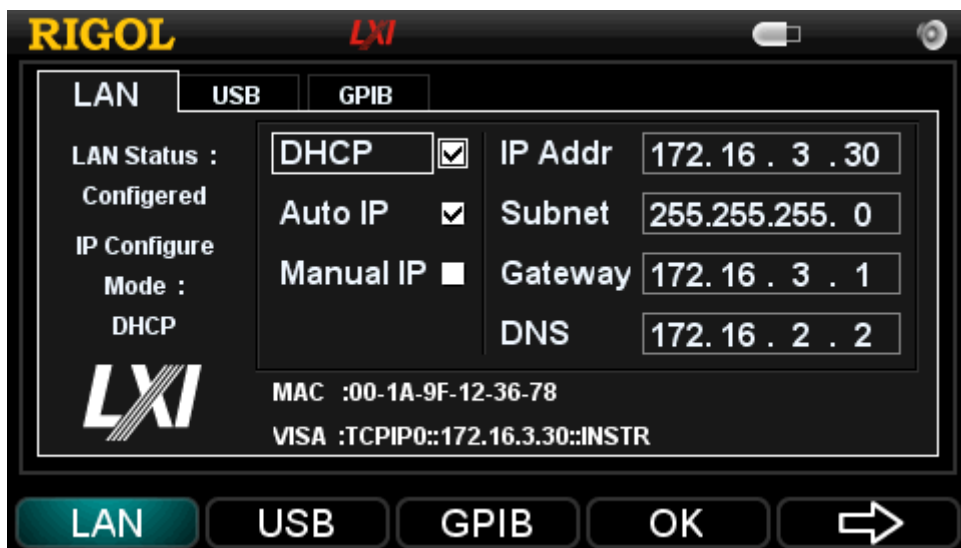

Figure 3-1 LAN setting interface

#### 2. Remote Control

Input the obtained IP address in the internet browser to enter an interface as shown in figure below, then click “Web Identification Indicator” and a message “Target identified!” will be shown on the screen of the instrument. To exit the message, click this item again.

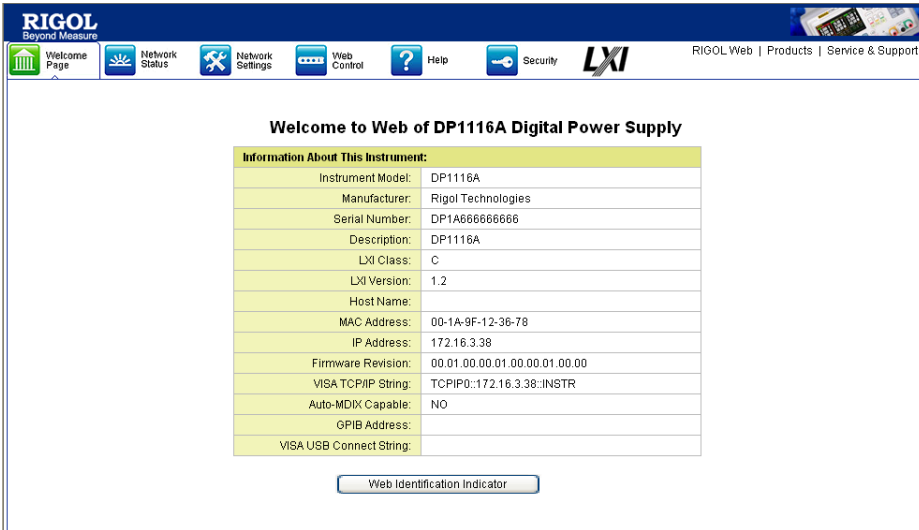

Figure 3-2 Welcome interface

- (1) Click "Network Status" and enter the network status interface as shown in figure below. From this interface, you can view the settings of TCP/IP and network hardware.

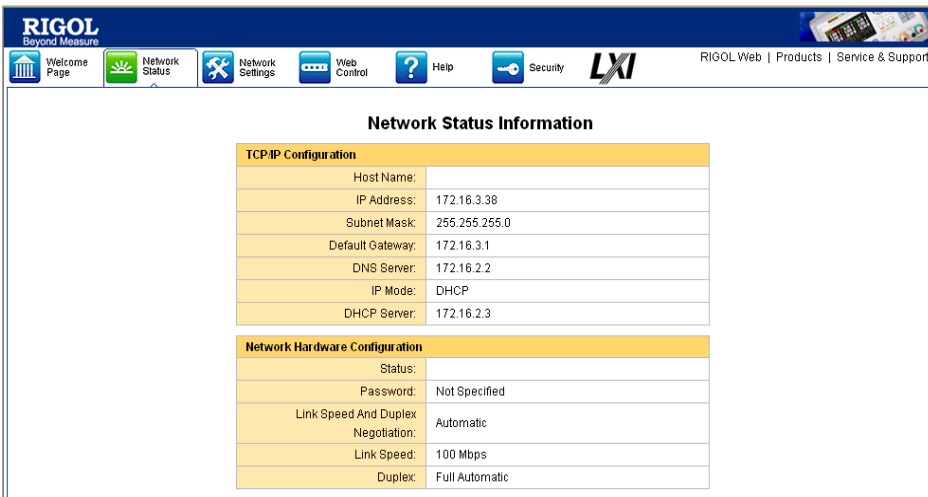

Figure 3-3 Network status interface

- (2) Click "Network Settings" and enter the IP setting interface, see figure below:

**RIGOL**  
Beyond Measure

Welcome Page | Network Status | Network Settings | Web Control | Help | Security | LXI | RIGOL Web | Products | Service & Support

### IP Settings

**Warning: A change in the IP Address will result in loss of connectivity to the browser.**

**IP Mode:** DHCP

**Host Name:**

**Domain Name:**

**IP Mode Setting**

DHCP  Manual IP  Auto-IP

**IP Address:**

**Subnet Mask:**

**Default Gateway:**

**DNS Server:**

**Other Settings**

**Description:**

Figure 3-4 Network setting interface

In this interface, you can set desired IP parameters, and then click “Apply” to apply the new setting or click “Cancel” to cancel the setting. To restore the factory defaults, click “LAN Configuration Initialize”.

**Note:**

If a password is necessary for the entrance of the web, click “Network Settings” and to enter the following dialog, here you should enter the correct user name and password (the default user name and password are empty). To create a new password or modify the password that has already existed please refer to “(4)”.

- (3) Click “Help” and enter the help interface for the information about the instrument and network, see figure below:

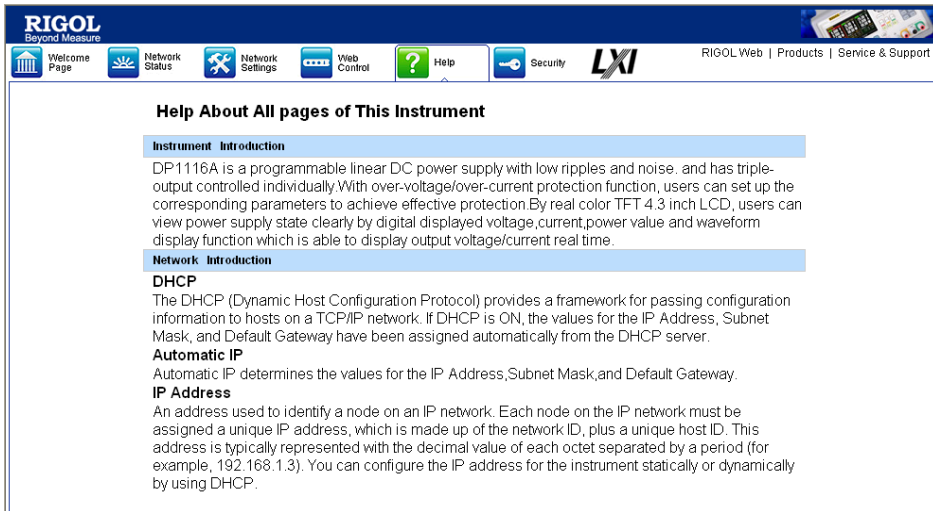

Figure 3-5 Help interface

- (4) Click “Security” icon and enter the network security setting interface. See figure below, enter the passwords as required and click “Apply”, a hint like “Note: Your password setting successful” will be shown on the screen.

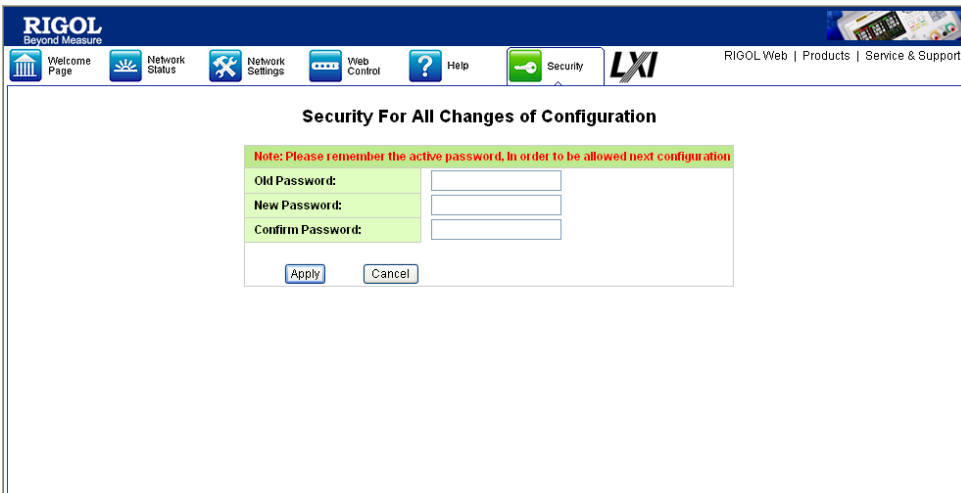

Figure 3-6 Network security setting interface

- (5) Click “LXI” icon and directly enter the official website of the LXI union “<http://www.lxistandard.org/>”.

## Command Control

The DP1116A Programmable DC Power Supply provides two ways for command control.

### User-defined Programming

Users can control the DP1116A according to SCPI (Standard Commands for Programmable Instruments). For more details about the programming, please refer to the Programming Guide of this product.

### Using PC software from RIGOL or other manufactories

Beside the software “Ultra Sigma” provided by **RIGOL**, you can also use the “Measurement & Automation Explorer” from NI (National Instruments Corporation) company or the “Agilent IO Libraries Suite” from Agilent (Agilent Technologies, Inc.) to control your DP1116A via remote interfaces by sending commands.

The DP1116A supports communications with a PC through USB, LAN or GPIB bus. In the following part, we will introduce you how to use the associated **Ultra Sigma** software to control the DP1116A through various interfaces. To get the **Ultra Sigma** software and the detailed operations please contact **RIGOL** technical support or your local sales office.

### 1. By USB

Please follow the steps below:

(1) Connect the instruments

Use a USB data cable to connect the USB Device port of your DP1116A to the USB Host of a PC.

(2) Install the USB driver

DP1116A is a USBTMC unit. After you connect it with the PC correctly, turn on the instrument (the instrument will automatically use the USB interface), a dialog appears on the PC screen and guide you to install the “USB Test and Measurement Device” driver.

(3) Search the available device

Open the **Ultra Sigma**, the software will automatically search the instruments that connected to the PC through the USB port. You can also search the device

through clicking . The status bar of the software during the search is:



Figure 3-7 Status bar of USB seraching

(4) View the available devices

Devices that have been detected will be listed under the “RIGOL Online Resource” in connection with their own model, USB information. See figure below:



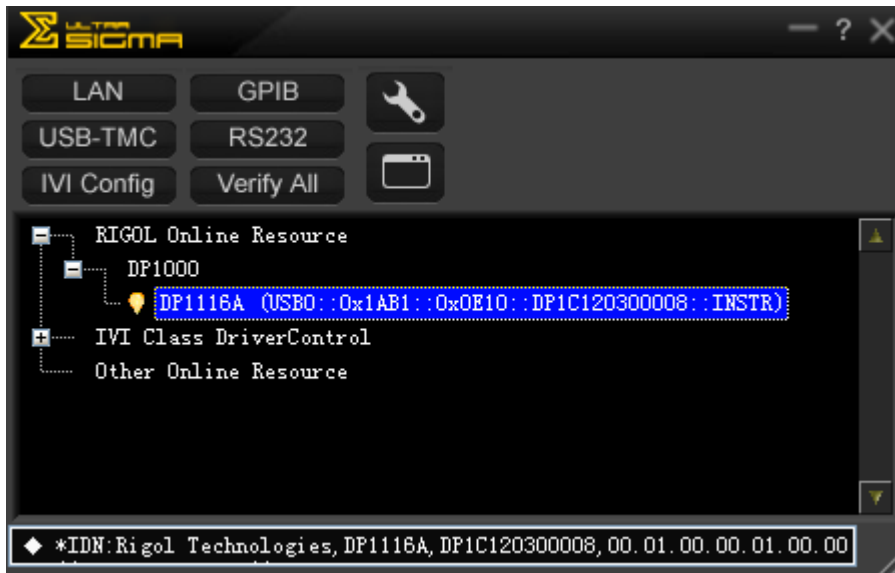

Figure 3-8 Available USB devices

## (5) Communication test

Right click "DP1116A (USB0::0x1AB1::0x0E10:: DP1C120300008::INSTR)" and select "SCPI Panel Control" to open the remote control panel and send commands or read the data, see figure below:

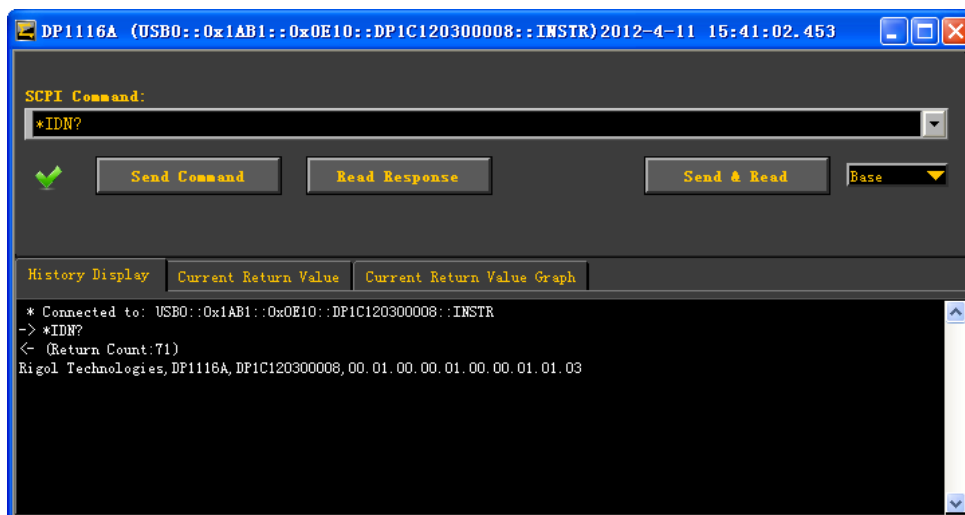

Figure 3-9 Read and write commands through USB

## 2. By LAN

Please follow the steps below:

- (1) Connect the instruments  
Use a Net cable to connect your DP1116A to LAN.
- (2) Configure the network parameter  
Select "LAN" referring to the "I/O Settings" in Chapter 2.
- (3) Search the available device



Open the **Ultra Sigma** and click . The window as shown in the figure below is displayed. Click  (as shown in Figure (a)) and the software searches for the instrument resources currently connected to the LAN and the resources found are displayed at the right of the window. As shown in Figure (b), select the desired resource name and click  to add it.



Figure (a)

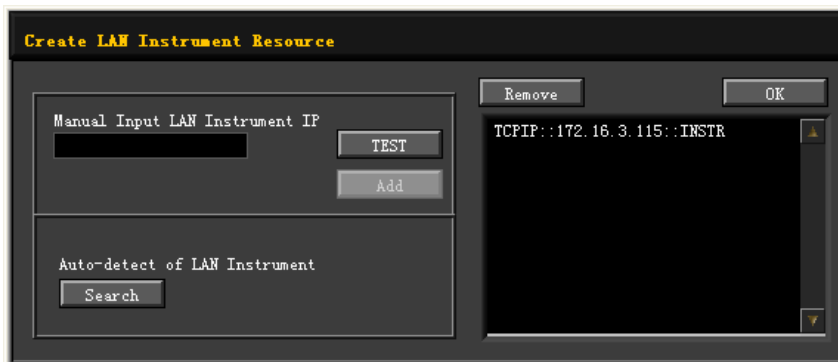

Figure (b)

Figure 3-10 Status bar of LAN searching

## (4) View the available devices

As shown in figure below, devices that have been detected will be listed under the “RIGOL Online Resource”.

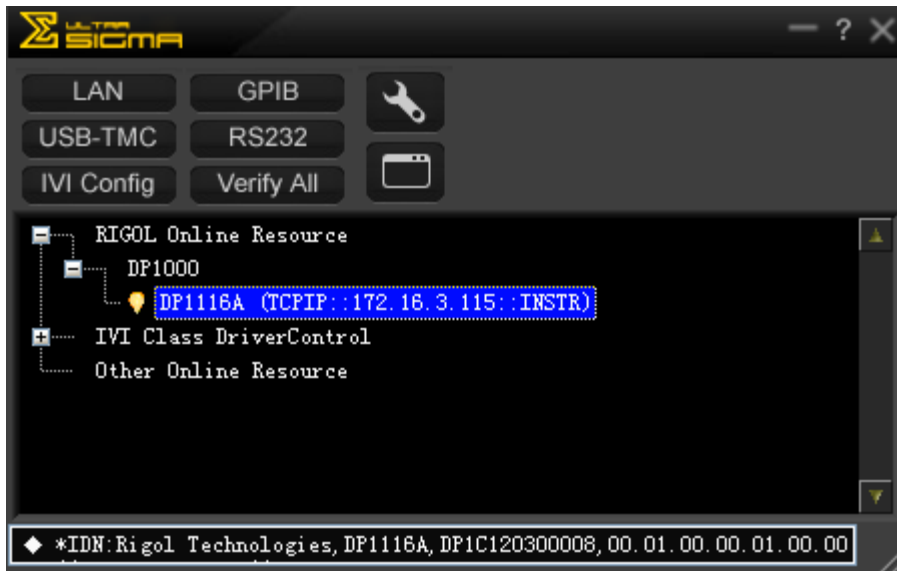

Figure 3-11 Available LAN resources

## (5) Communication test

Right click “DP1116A (TCPIP::172.16.3.115::INSTR)” and select “SCPI Panel Control” to open the remote control panel and send commands or read the data, see figure below:

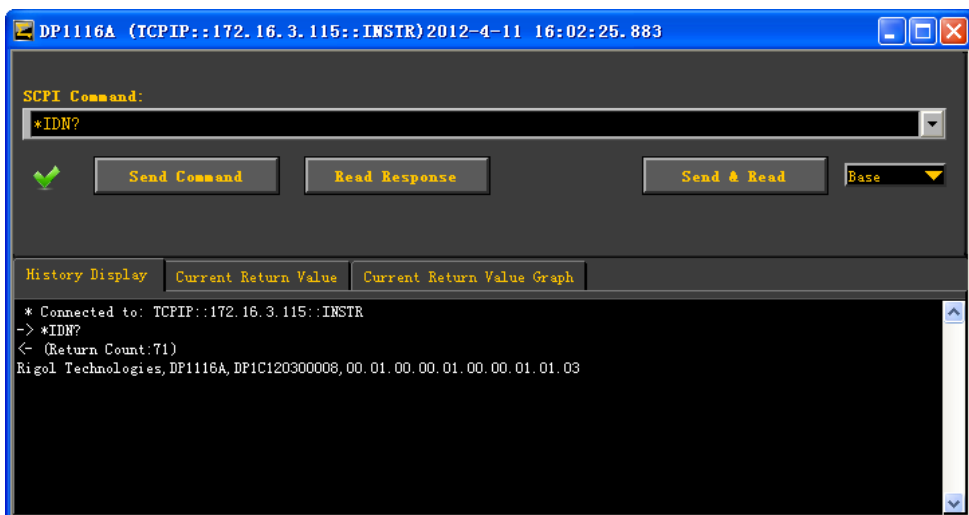

Figure 3-12 Read and write commands through LAN

(6) Load the LXI web page

The DP1116A conforms to the LXI-C standards (Version 1.2). You can load the LXI web page through **Ultra Sigma** (right click the instrument name and select “LXI-Web”), from this page you can view the instrument information, including the instrument model, manufacturer, series number, description, MAC address and IP address. See figure below:

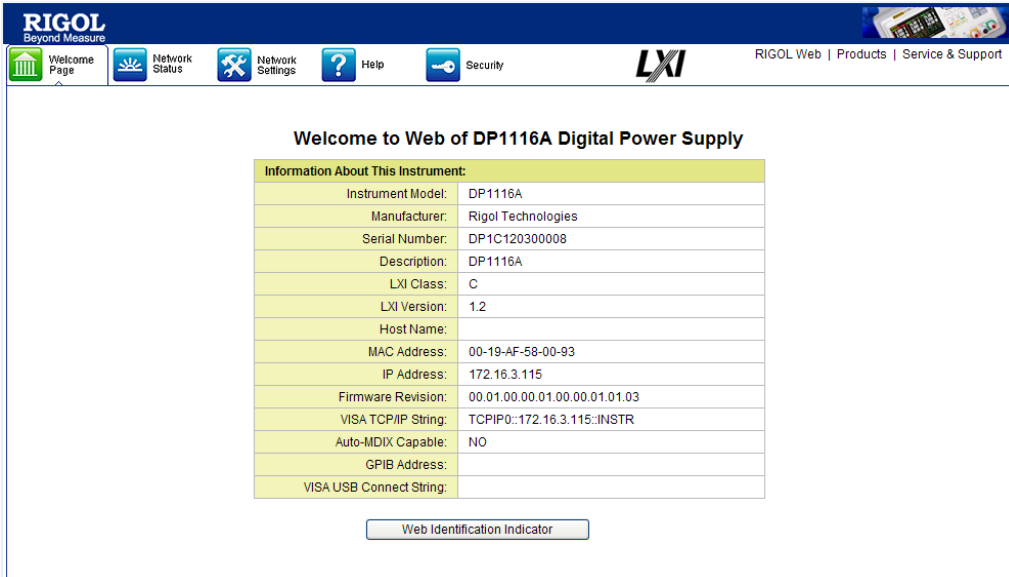

Figure 3-13 LXI web page

3. By GPIB

Please follow the steps below:

(1) Connect the instruments

Use a GPIB cable to connect your DP1116A to a PC.

(2) Set the GPIB address

See “I/O Settings” in Chapter 2, select “GPIB” interface and configure its GPIB address.

(3) Search the available device

Open the **Ultra Sigma** and click  to enter the following interface, then click “Search” to search the devices connected to the PC through GPIB port. The searched devices are listed on the right side of the panel, see figure below:



Figure 3-14 GPIB configurations

#### When cannot search a device automatically:

- Select the address of the GPIB card used in your computer and the GPIB address of DP1116A from the pull-down options of “GPIB::” and “INSTR::” respectively.
- Click “Test” and verify if the GPIB communication is successful. If failed, please follow the guide step by step.

#### (4) View the available devices

Click “OK” and go back to the main screen of the **Ultra Sigma**. The detected GPIB resources are listed under the “RIGOL Online Resource”.

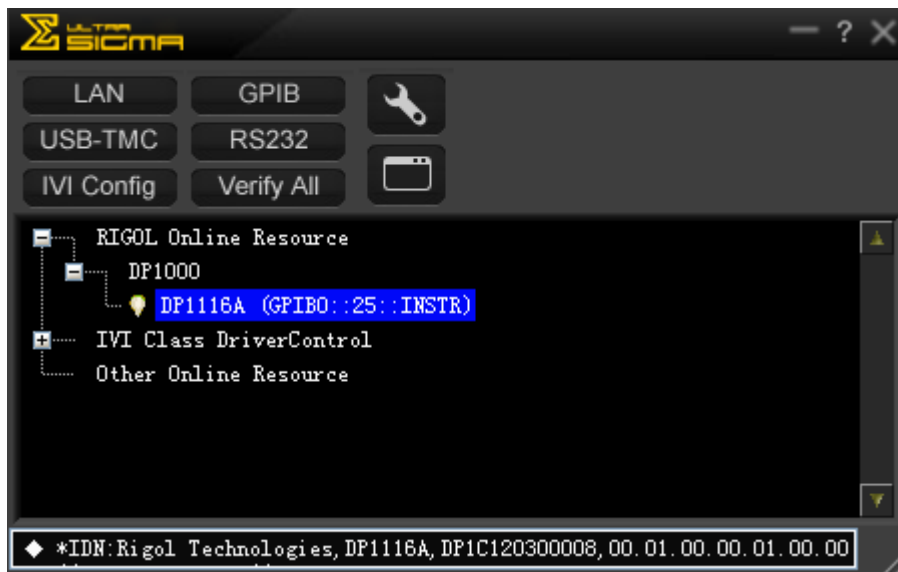

Figure 3-15 Available GPIB devices

## (5) Communication test

Right click the “DP1116A (GPIB0::25::INSTR)” and select “SCPI Panel Control” to enter the remote control panel and send commands or read the data, see figure below:

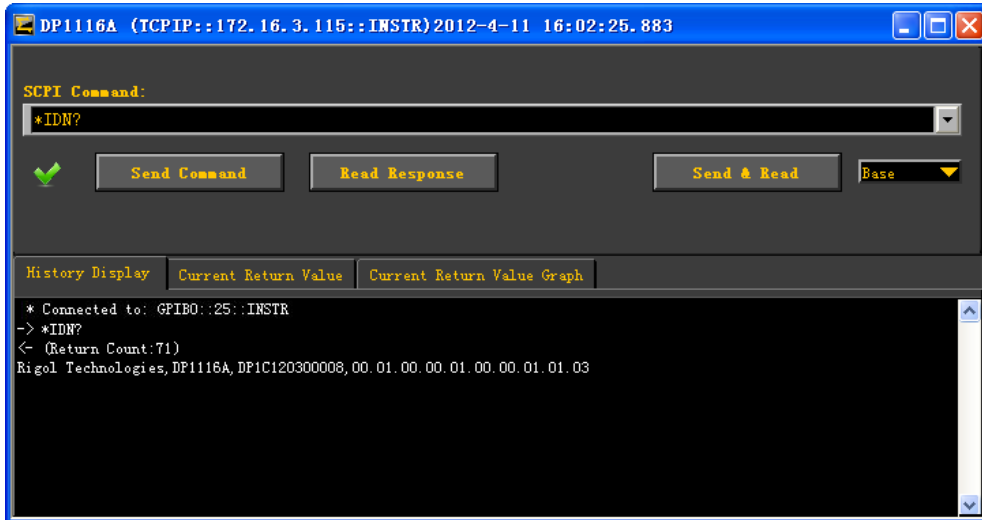

Figure 3-16 Read and write commands by GPIB

## Chapter 4 Troubleshooting

### 1. The screen still dark (no display) after power on:

- (1) Check the power connection.
- (2) Check if the power indicator is lighting and flickering.
- (3) Disconnect the power cord and check if the Voltage Selector is in proper scale and a right fuse is used and in good condition.
- (4) If the error still exists, please contact **RIGOL** for help.

### 2. Constant voltage output is abnormal:

- (1) Check if the maximum power from the selected scale can meet the load requirement.
- (2) If meets, please:
  - Check if the cable that used for connecting the load with the instrument is in good condition or has a short circuit.
  - Check if the load goes wrong.
  - Check if a proper current in this scale is specified; if the value is too low, increase it properly.
- (3) If the error still exists, please contact **RIGOL** for help.

### 3. Constant current output is abnormal:

- (1) Check if the maximum power from the selected scale can meet the load requirement.
- (2) If meets, please:
  - Check if the cable that used for connecting the load with the instrument is in good condition or open circuit.
  - Check if the load goes wrong.
  - Check if a proper voltage in this scale is specified; if the value is too low, increase it properly.
- (3) If the error still exists, please contact **RIGOL** for help.

### 4. Cannot identify the USB device correctly:

- (1) Check if the USB device is in good condition.
- (2) Check if the used USB device is a flash device, note a hard disk cannot be supported by DP1116A.
- (3) Restart the instrument and insert your USB flash device again.
- (4) If the error still exists, please contact **RIGOL** for help.





## Chapter 5 Specifications

The specification and operating characteristics are based on the instrument having been operated continuously for 30 minutes under the specified operating temperature.

**Note:** All the specifications below apply to both the two scales unless where noted.

Model	DP1116A	
Scale	16 V/10 A	32 V/5 A
<b>Output Ratings (0°C - 40°C)</b>		
Voltage	0 - 16 V	0 - 32 V
Current	0 - 10 A	0 - 5 A
Overvoltage Protection	0.1 V - 35.2 V	
Overcurrent Protection	0.1 A - 11 A	
<b>Load Regulation± (output percentage + offset)</b>		
Voltage	< 0.01% + 2 mV	
Current	< 0.005% + 250 µA	
<b>Line Regulation± (output percentage + offset)</b>		
Voltage	< 0.01% + 2 mV	
Current	< 0.01% + 250 µA	
<b>Ripple and Noise (20 Hz ~ 20 MHz)</b>		
Normal Mode Voltage	< 350 µV rms/3 mVpp	
Normal Mode Current	< 2 mA rms	
<b>Accuracy 12 Months<sup>[1]</sup> (25°C ± 5°C) ± (output percentage + offset)</b>		
Program ming	Voltage	0.05% + 10 mV
	Current	0.2% + 10 mA
Read Back	Voltage	0.05% + 5 mV
	Current	0.15% + 5 mA
<b>Resolution</b>		
Programming	1 mV/1 mA	
Read Back	1 mV/1 mA	
Meter	1 mV/1 mA	
<b>Transient Response Time</b>		
Less than 50 µs is spent on recovering the voltage within 15 mV when the output current changes from full load to half load or half to full.		

<b>Remote Sensing (Sense)</b>		
Each Sense lead can compensate up to 1V voltage drop for each load lead.		
<b>Command Processing Time</b> <sup>[2]</sup>		
< 50 ms		
<b>Temperature Coefficient, ± (output percentage + offset)</b>		
(The maximum varieties of Output/Read Back for each 1 °C change of temperature after 30 minutes warm-up.)		
Voltage		0.01% + 3 mV
Current		0.02% + 3 mA
<b>Stability</b> <sup>[3]</sup> , ± (output percentage + offset)		
Voltage		0.02% + 1 mV
Current		0.1% + 1 mA
<b>Voltage Programming Speed (1% of total variation range)</b>		
Rising	Full Load	50 ms
	No Load	20 ms
Falling	Full Load	45 ms
	No Load	400 ms
<b>OVP/OCP</b>		
Accuracy ± (output percentage + offset)		0.5% + 0.5 V/0.5% + 0.5 A
Activation Time		1.5 ms (OVP ≥ 3 V); < 10 ms (OVP < 3 V) < 10 ms (OCP)
<b>Mechanical</b>		
Dimension		235 mm (W) x 155 mm (H) x 384 mm (D)
Weight		11 kg
<b>Power Supply</b>		
AC input (50 Hz – 60 Hz)		100 Vac ± 10%, 115 Vac ± 10%, 220 Vac ± 10%, 230 Vac ± 10% (up to 250 Vac)
<b>Environment</b>		
Working Temperature		Full rating output: 0 °C ~ 40 °C At high temperature: the output current drops to 50% at 55 °C of maximum.
Cooling		Fan cooling
Product Regulation		CE, cTUVus

**Remarks:**

[1] Specifications are for one hour warm-up and at 25 °C.

[2] The maximum time required for regulating the corresponding output when received APPLY

and SOURce commands.

- [3] The varieties of outputs within 8 hours when the instrument has been warmed up for 30 minutes and both the load circuit and environment temperatures are in constant conditions.



## Chapter 6 Appendix

### Appendix A: Accessories

- A power cord that fits the standard of destination country
- A USB data cable
- A CD (including User's Guide)
- An Instruction
- 4 fuses (250 V / T2.5 A and 250 V / T4 A, 2 for each)
- 2 shorted devices

**Note: All the accessories can be ordered from your local RIGOL office.**

## Appendix B: Warranty

**RIGOL** warrants that its products mainframe and accessories will be free from defects in materials and workmanship within the warranty period.

If a product is proven to be defective within the respective period, **RIGOL** guarantees the free replacement or repair of products which are approved defective. To get repair service, please contact with your nearest **RIGOL** sales and service office.

**RIGOL** does not provide any other warranty items except the one being provided by this summary and the warranty statement. The warranty items include but not being subjected to the hint guarantee items related to tradable characteristic and any particular purpose. **RIGOL** will not take any responsibility in cases regarding to indirect, particular and ensuing damage.

# Index

Built-in Help .....	2-35	Output Inspection.....	1-10
Calibrate .....	2-32	Overvoltage/Overcurrent Protection	
Command Control .....	3-5	.....	2-9
Command Processing Time .....	5-2	Parameter Input .....	2-2
Constant Current Output .....	2-8	Power Supply .....	5-2
Constant Voltage Output.....	2-5	Power-On Check.....	1-9
DC output ratings .....	5-1	Rear Panel .....	1-6
Display Mode.....	1-12	Ripple.....	5-1
Environment.....	5-2	Specifications.....	5-1
Focus.....	2-21	Stability .....	5-2
Front Panel .....	1-3	Store and Recall .....	2-19
General Inspection .....	1-2	System Settings.....	2-27
GPIO.....	2-26	Temperature Coefficient .....	5-2
I/O Settings .....	2-24	Timer Setting .....	2-33
Key Lock .....	2-36	Timing Output.....	2-14
LAN .....	2-24	Transient Response Time.....	5-1
Linear Regulation.....	5-1	Troubleshooting.....	4-1
Load Regulation.....	5-1	USB .....	2-25
Mechanical .....	5-2	User Interface .....	1-7
Noise.....	5-1	Utility Settings.....	2-23
O.C.P.....	2-12	Voltage Programming Speed.....	5-2
O.V.P .....	2-10	Working Mode of Sense.....	2-17